

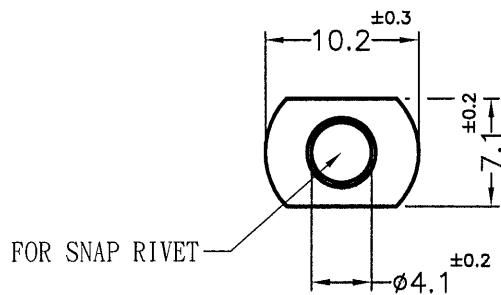

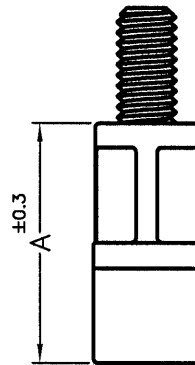

REVISIONS			
REV	DESCRIPTION	DATE	BY

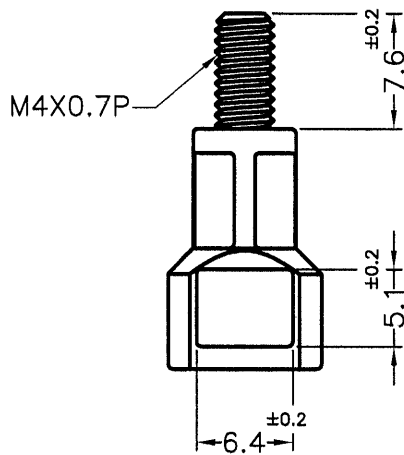

PART NO.	A
TCEB4-12.7	12.7
TCEB4-15.9	15.9
TCEB4-19.1	19.1
TCEB4-22.2	22.2
TCEB4-25.4	25.4

NOTE:MADE OF EQUIVALENT MATERIAL.
均可使用同等材質。

 <p>康揚企業股份有限公司 KANG YANG HARDWARE ENTERPRISE CO., LTD. 康揚塑膠(東莞)有限公司 KANG YANG PLASTIC(DONG GUAN) CO., LTD. 康哲電腦配件(吳江)有限公司 KANG CHE COMPUTER COMPONENTS(WUJIANG) CO., LTD.</p>		TITLE SPACER SUPPORT	SPEC. DWG.
		MATERIAL NYLON 66 UL94V-2	DATE 2016.09.23
PART NUMBER SEE ABOVE		FINISH	DRAWN Y.C.P
DRAWING NUMBER TCEB4-H		COLOR NATURAL	CHECK 
SIZE A4	SCALE 2:1	UNLESS OTHERWISE SPECIFIED TOLERANCE SEE ABOVE	APPROVED 
UNIT mm	REV A		