

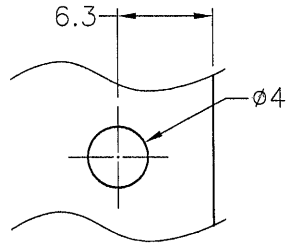

REVISIONS			
REV	DESCRIPTION	DATE	BY

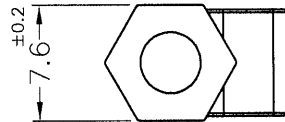

MOUNTING HOLE  
THICKNESS: 1.6mm

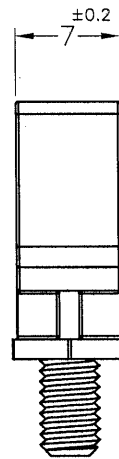
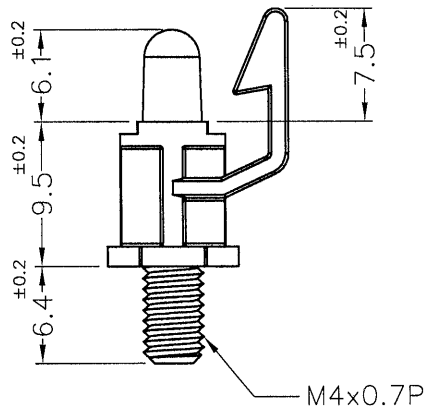

NOTE: 1. SHRINKING IS NORMAL STATUS.  
內縮為正常現象。  
2. MADE OF EQUIVALENT MATERIAL.  
均可使用同等材質。

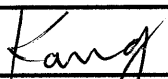
 <p>康揚企業股份有限公司 KANG YANG HARDWARE ENTERPRISE CO., LTD. 康揚塑膠(東莞)有限公司 KANG YANG PLASTIC(DONG GUAN) CO., LTD. 康哲電腦配件(吳江)有限公司 KANG CHE COMPUTER COMPONENTS(WUJIANG) CO., LTD.</p>				TITLE	SPACER SUPPORT	SPEC. DWG.	
				MATERIAL	NYLON 66 UL94V-2	DATE	2018.09.27
				FINISH		DRAWN	C. S. L
				COLOR	NATURAL	CHECK	
PART NUMBER	ULCBM4-9.5	DRAWING NUMBER	ULCBM4-9.5	UNLESS OTHERWISE SPECIFIED TOLERANCE	SEE ABOVE	APPROVED	
SIZE	A4	SCALE	2:1	UNIT	mm	REV	A