

Patented Product

專利產品

REVISIONS

REV	DESCRIPTION	DATE	BY

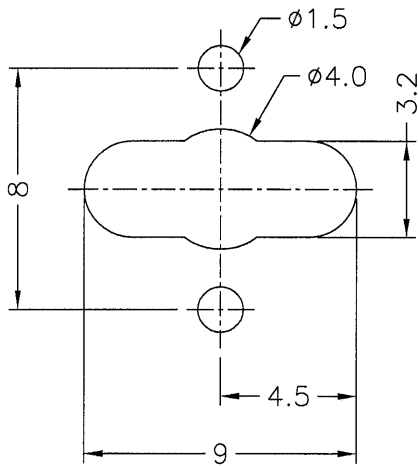
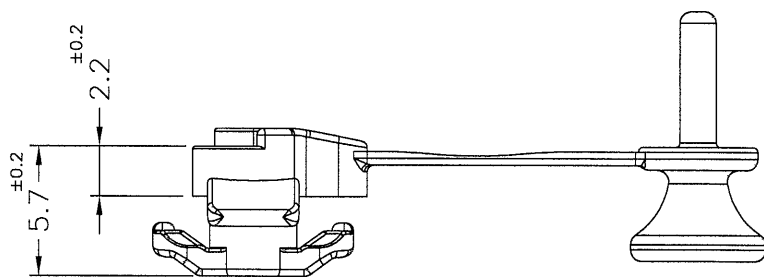
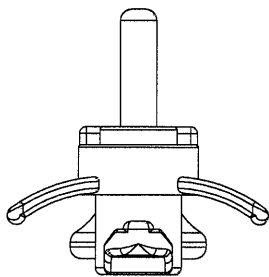
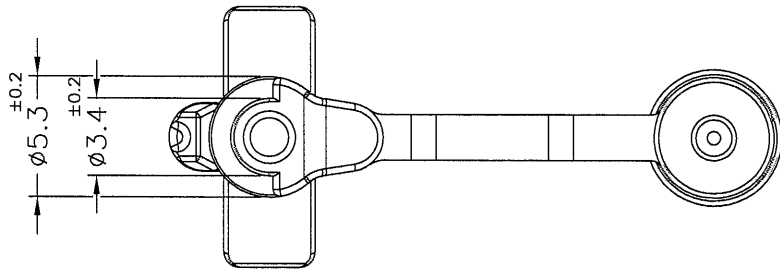

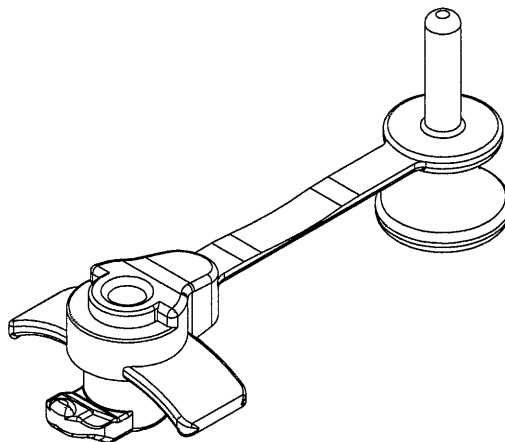

MOUNTING HOLE  
THICKNESS:1.2mm



PART NO.	COLOR
ULCN2.2-1.2(B)	BLACK
ULCN2.2-1.2(BU)	BLUE (PANTON 659C)

NOTE:1. MADE OF EQUIVALENT MATERIAL.  
均可使用同等材質  
2. SHRINKING IS NORMAL STATUS.  
內縮為正常現象

 康揚企業股份有限公司  
 KANG YANG HARDWARE ENTERPRISE CO., LTD.  
 康揚塑膠(東莞)有限公司  
 KANG YANG PLASTIC(DONG GUAN )CO.,LTD.  
 康哲電腦配件(吳江)有限公司  
 KANG CHE COMPUTER COMPONENTS(WUJIANG) CO.,LTD.

TITLE	SPACER SUPPORT	SPEC. DWG.
MATERIAL	NYLON 66 UL94V-2	DATE 2016.01.05
FINISH		DRAWN C.S.L
COLOR	SEE ABOVE	CHECK 
PART NUMBER	SEE ABOVE	DRAWING NUMBER ULCN2.2-1.2
UNLESS OTHERWISE SPECIFIED TOLERANCE	SEE ABOVE	APPROVED 
SIZE A4	SCALE 3:1	UNIT mm
		REV A