

Patented Product
專利產品

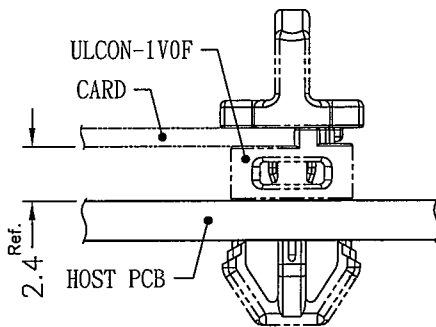

Assembly Diagram

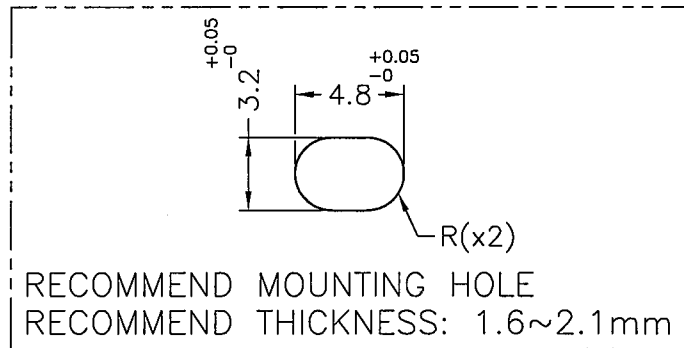
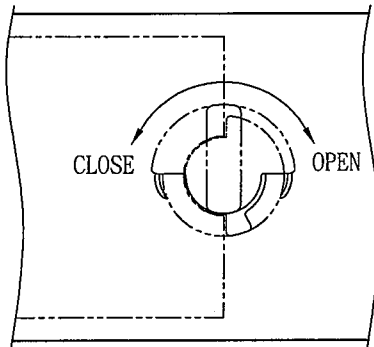
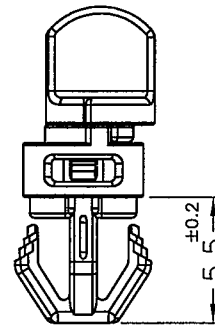
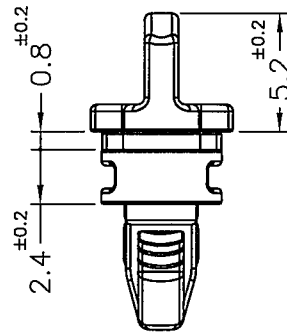
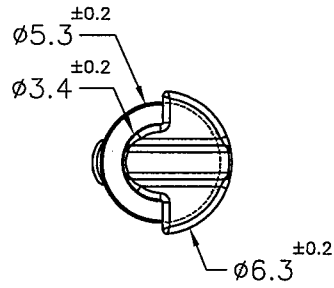
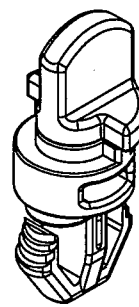

OPEN

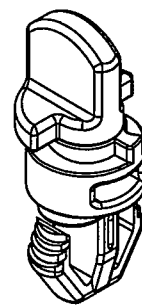

CLOSE

- NOTE: 1. THE COLOR BATCH TEST REPORT IS ONLY FOR FIRST LOT TEST.
色母環保檢測報告, 僅提供原始測試報告。
2. MADE OF EQUIVALENT MATERIAL.
均可使用同等材質。
3. SLIGHT DEFORMED IS NORMAL STATUS.
輕微變形為正常現象。



康揚企業股份有限公司
KANG YANG HARDWARE ENTERPRISE CO., LTD.
康揚塑膠(東莞)有限公司
KANG YANG PLASTIC(DONG GUAN)CO., LTD.
康哲電腦配件(吳江)有限公司
KANG CHE COMPUTER COMPONENTS(WUJIANG)CO., LTD.

PROPRIETARY AND CONFIDENTIAL THE INFORMATION CONTAINED IN THIS DRAWING IS THE SOLE PROPERTY OF KANG YANG HARDWARE ENTERPRISE CO. ANY REPRODUCTION IN PART OR AS A WHOLE WITHOUT THE WRITTEN PERMISSION OF KANG YANG HARDWARE ENTERPRISE CO. IS PROHIBITED. DO NOT SCALE DRAWING	DATE	2020.12.22	TITLE	LATCH SPACER SUPPORT	DWG. NO.	ULCON-1	PART NO.	ULCON-1V0F
	DRAWN	K.W	LATCH BASE MATERIAL / COLOR	NYLON66 UL94V-0 / BLACK	SIZE	A4	SPEC. DWG	REV
	CHECKED		LATCH TURN HANDLE MATERIAL / COLOR	NYLON66 UL94V-0+GF / BLUE	SCALE	3:1	UNIT	mm
	APPROVED		UNLESS OTHERWISE SPECIFIED TOLERANCE:	SEE ABOVE				SHEET 1 OF 1