

DIM.	TOL
L≤10	±0.2
10<L≤30	±0.3
30<L≤50	±0.5
50<L≤100	±0.7
100<L≤250	±1.2
ABOVE 250	±1.5

REVISIONS			
REV	DESCRIPTION	DATE	BY

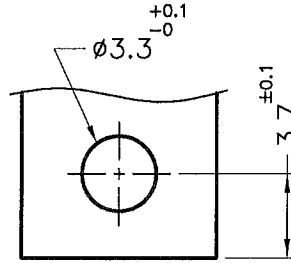

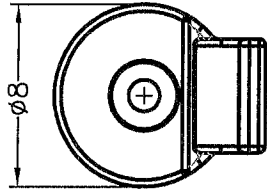
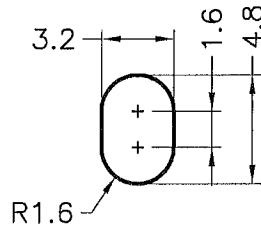
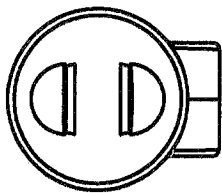
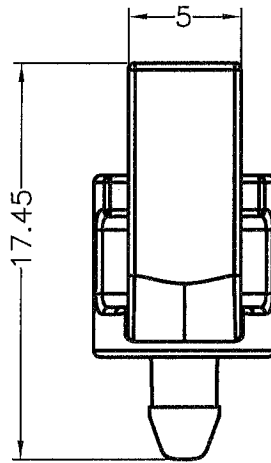
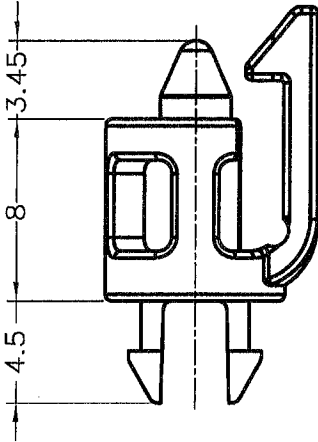

HOLE IN P.C.B  
P.C.B THICKNESS:1.57mm



HOLE IN P.C.B  
P.C.B THICKNESS:2.13mm

NOTE:All measurement does not include gate which raises under 0.3mm.

 康揚企業股份有限公司 KANG YANG HARDWARE ENTERPRISE CO., LTD. 康揚塑膠(東莞)有限公司 KANG YANG PLASTIC(DONG GUAN) CO.,LTD. 康哲電腦配件(吳江)有限公司 KANG CHE COMPUTER COMPONENTS(WUJIANG) CO.,LTD.		TITLE	SPACER SUPPORT	SPEC. DWG	
		MATERIAL	NYLON 66 UL94V-2	DATE	2014.10.16
PART NUMBER		COLOR	NATURAL	DRAWN	LUKE
ULCSA-8		UNLESS OTHERWISE SPECIFIED TOLERANCE	SEE ABOVE	CHECK	
DRAWING NUMBER	ULCSA-8	APPROVED			
SIZE	A4	SCALE	3:1	UNIT	mm
		REV	A		