

Patented Product

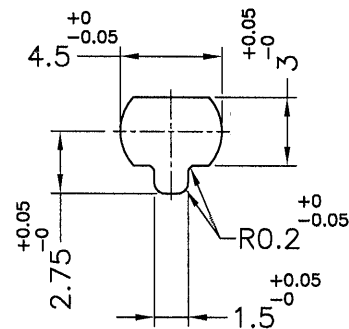

專利產品

REVISIONS			
REV	DESCRIPTION	DATE	BY

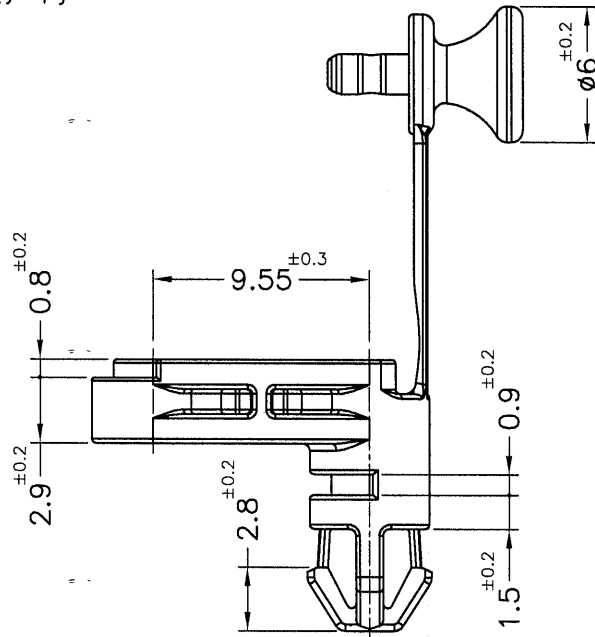
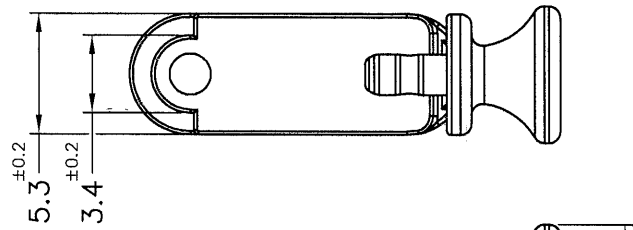
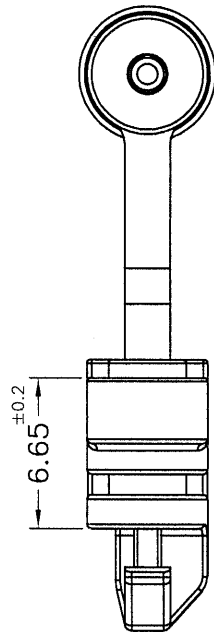

RECOMMEND MOUNTING HOLE $+0/-0.05$
 RECOMMEND THICKNESS: 1.6mm

- NOTE: 1. MADE OF EQUIVALENT MATERIAL.
 均可使用同等材質。
 2. SLIGHT DEFORMED IS NORMAL STATUS.
 輕微變形為正常現象。

 康揚企業股份有限公司 KANG YANG HARDWARE ENTERPRISE CO., LTD. 康揚塑膠(東莞)有限公司 KANG YANG PLASTIC(DONG GUAN) CO., LTD. 康哲電腦配件(吳江)有限公司 KANG CHE COMPUTER COMPONENTS(WUJIANG) CO., LTD.				TITLE	SPACER SUPPORT	SPEC. DWG.	
				MATERIAL	NYLON 66 UL94V-2	DATE	2017.04.21
				FINISH		DRAWN	K.W
				COLOR	BLACK	CHECK	
PART NUMBER	ULD-1(B)	DRAWING NUMBER	ULD-1	UNLESS OTHERWISE SPECIFIED TOLERANCE	SEE ABOVE	APPROVED	
SIZE	A4	SCALE	3:1	UNIT	mm	REV	A