

5



- 護線環
Snap Bushing
- 橡膠線環
Grommet
- 抗震線環
Anti-Vibration Grommet
- 扣式塞頭
Hole Plug
- 電源線扣
Strain Relief Bushing
- 束線帶/黏扣帶
Cable Tie / Velcro
- PVC套管
PVC Tube
- 熱縮套管
Heat Shrink Tubing
- 黏貼標誌貼紙
Wire Label
- 工具
Tool



護線環 SNAP BUSHING

用途：用於機殼的電線出線口，保護電線不受機殼刮傷，裝配容易。

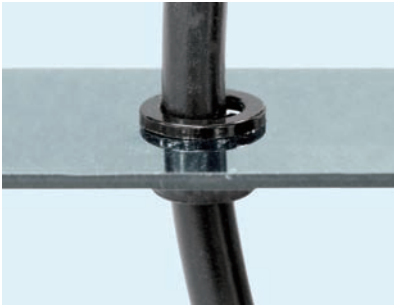

- Material: Nylon 66 (UL)
- Flame Class: 94V-2/94V-0
- Color: Natural/Black
- Unit: mm

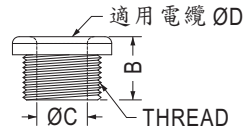

MOUNTING HOLE: ØG

Part No.	A	B	C	D	G	Thread	搭配螺帽	Package
MGM-10	15.0	12.0	7.0	6.5	10.0~10.5	M10x1.5P	M-10N	500
MGM-12	18.0	12.0	8.8	8.5	12.0~12.5	M12x1.5P	KGB12-07A	
MGM-16	21.7	13.5	11.2	11.0	16.0~16.5	M16x1.5P	KGB16-10A	
MGM-20	26.8	13.5	15.2	15.0	20.0~20.5	M20x1.5P	KGB20-14A	100
MGM-25	32.6	14.0	19.2	19.0	25.0~25.5	M25x1.5P	KGB25-16A	
MGM-32	42.0	19.0	26.2	26.0	32.0~32.5	M32x1.5P	KGB32-25A	



- Material: Nylon 66 (UL)
- Flame Class: 94V-2/94V-0
- Color: Black
- Unit: mm



Part No.	A	B	C	G	T	Package	UL
NB-0710	12.1	6.6	7.2	10.0	0.8~1.8	1000	UL
★NB-1114	16.7	10.3	11.3	14.3	3.2		UL
NB-1215	17.8	6.3	12.7	15.8	0.8~1.6		UL
NB-1217	20.0	10.3	12.7	17.5	0.8~3.3	200	UL
NB-1419	21.5	11.3	14.3	19.0	0.8~3.3		UL
★NB-1419S	21.41	10.31	14.27	19.1	0.81~3.18	200	UL
NB-1722	25.1	11.2	18.6	22.2	0.8~3.3		UL
NB-1922	23.8	6.3	19.0	22.2	0.8~1.6		500
NB-1925	28.0	10.8	19.4	25.4	0.8~3.3	100	UL
NB-2428	31.5	11.3	24.1	28.0	1.0~3.3	200	UL
NB-2430	34.0	11.7	24.5	30.1	0.8~3.3		UL
★NB-2432	34.5	11.4	23.8	31.8	3.2		UL
NB-2535	37.8	11.3	25.8	35.0	0.8~3.5	200	UL
NB-2935	37.8	11.3	29.7	35.0	0.8~3.5		UL
NB-2634	38.0	11.5	26.2	34.2	1.0~3.1		UL
NB-3034	38.0	11.5	30.4	34.2	1.0~3.1	200	UL
NB-3338	41.2	11.6	33.3	38.1	1.0~3.3		UL
★NB-3545	47.6	11.5	34.9	44.5	3.2		UL
NB-4150	53.8	11.4	41.8	50.8	0.8~3.2	100	UL
NB-4450	53.8	11.4	44.3	50.8	0.8~3.2		UL
NB-4757	63.0	18.1	47.3	57.1	6.35		UL
NB-5063	67.5	18.1	50.5	63.5	6.35	50	UL
NB-5563	67.5	18.1	55.5	63.5	6.35		UL

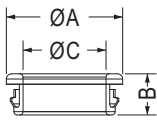
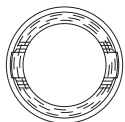

MOUNTING HOLE: ØG
THICKNESS: T

[NB-1215]

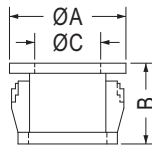
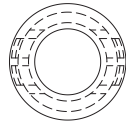

MOUNTING HOLE: ØG
THICKNESS: T

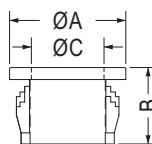
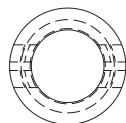

MOUNTING HOLE: ØG
THICKNESS: T



Part No.	A	B	C	G	T	Package	UL
★250-2	8.0	8.0	3.6	6.4	1.6	1000	UL
312-3	9.5	8.2	5.2	8.0	0.8~1.8		UL
375-4	12.0	10.3	6.6	9.5	0.8~3.3		UL
0811	13.6	10.3	8.4	11.1	0.8~3.3		UL
0813	15.1	10.3	9.8	12.7	0.8~3.3		UL
1216	18.2	10.3	12.8	16.0	0.8~3.3		UL

開口式護線環 SNAP BUSHING

用途：用於機殼的電線出線口，保護電線不受機殼刮傷，裝配容易。



- Material: Nylon 66 (UL)
- Flame Class: 94V-2/94V-0
- Color: Black
- Unit: mm
- 採開口式量法

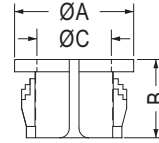
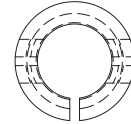

MOUNTING HOLE: ØG
THICKNESS: T



Part No.	A	B	C	G	T	Package	UL
0609C	11.9	6.5	7.3	9.5	0.6~1.6	1000	UL
0813C	15.0	9.8	9.7	12.7	0.8~3.3		UL
1014C	16.6	10.3	10.6	14.3	0.8~3.2		UL
1216C	18.4	10.4	12.8	15.9	0.8~3.3		UL
1419C	20.7	10.4	15.1	19.0	0.8~3.3		UL

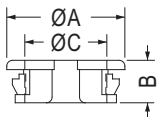
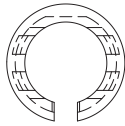

MOUNTING HOLE: ØG
THICKNESS: T



Part No.	A	B	C	G	T	Package
NB-09	12.4	6.0	7.6	9.5	0.8~1.2	1000
NB-12	16.8	7.3	10.8	12.7	0.8~1.2	
NB-16	20.3	7.3	14.1	15.9	0.8~1.0	500
NB-19	22.5	7.3	16.5	19.0	0.8~1.0	
NB-22	26.0	7.3	20.0	22.0	0.8~1.0	
NB-25	28.6	7.9	22.0	25.4	0.8~1.6	

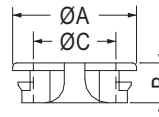
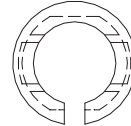

MOUNTING HOLE: ØG
THICKNESS: T



Part No.	A	B	C	G	T	Package
NB-07A	10.4	4.8	6.0	7.0	0.8~1.0	1000
NB-12A	16.2	5.2	10.8	12.7	0.8~1.0	
NB-16A	19.3	5.2	13.0	16.0	0.8~1.0	500
NB-19A	23.0	5.5	15.6	19.0	0.8~1.0	
NB-21A	25.0	5.6	19.0	21.0	0.8~1.0	
NB-22A	25.8	5.5	19.5	22.0	0.8~1.0	
NB-23A	26.4	5.5	20.4	23.0	0.8~1.0	
NB-24A	27.0	5.3	20.8	24.0	0.8~1.0	
NB-27A	34.6	6.0	27.0	27.0	0.8~1.0	
NB-29A	34.0	7.0	26.3	29.0	0.8~1.0	
NB-30A	36.25	7.0	28.0	30.0	0.8~1.0	
NB-32A	36.9	6.7	30.0	32.0	0.8~1.2	

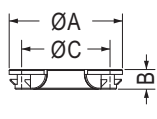

MOUNTING HOLE: ØG
THICKNESS 0.8~1.2



Part No.	A	B	C	G	Package
NB-27C	34.6	6.0	27.0	27.0	500
NB-29C	34.6	7.0	27.0	29.0	
NB-32C	36.9	6.7	30.0	32.0	

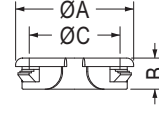

MOUNTING HOLE: ØG
THICKNESS: T



Part No.	A	B	C	G	T	Package
NB-22T	26.4	5.5	20.3	22.0	0.6~0.8	500
NB-25T	30.3	8.0	23.3	25.4	0.6~1.4	
NB-25TS	30.3	8.0	23.3	25.0	0.6~1.6	

開口式護線環 SNAP BUSHING

用途：用於機殼的電線出線口，保護電線不受機殼刮傷，裝配容易。

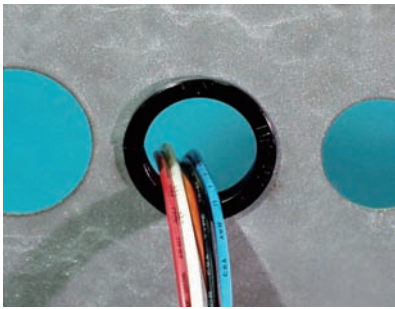

- Material: Nylon 66 (UL)
- Flame Class: 94V-2/94V-0
- Color: Black
- Unit: mm
- 採開口式量法

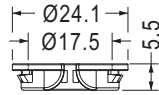

MOUNTING HOLE $\varnothing 19.5$
THICKNESS 0.6

Part No.	Package
NB-19.5T	500

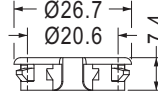
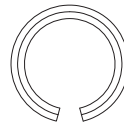

MOUNTING HOLE $\varnothing 22.0$
THICKNESS 0.6~0.8

Part No.	Package
NB-22J	500

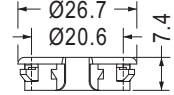
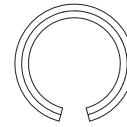

MOUNTING HOLE $\varnothing 22.0$
THICKNESS 0.8~1.0

Part No.	Package
NB-22U	500



- Material: Nylon 66 (UL)
- Flame Class: 94V-2/94V-0
- Color: Natural
- Unit: mm
- 採開口式量法

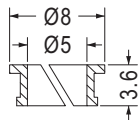
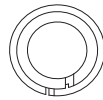

MOUNTING HOLE $\varnothing 6.3$
THICKNESS 2.0

Part No.	Package
★NC-6	2000

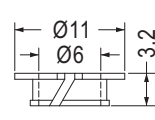
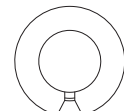

MOUNTING HOLE $\varnothing 7.25$
THICKNESS 1.1

Part No.	Package
NC-7	1000

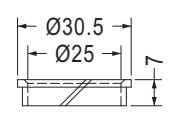
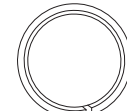

MOUNTING HOLE $\varnothing 28.0$

Part No.	Package
NC-28A	500



- Material: Nylon 66 (UL)
- Flame Class: 94V-2/94V-0
- Color: Natural/Black
- Unit: mm

FOR $\varnothing 3.0$ CABLE

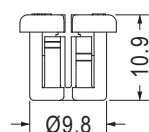
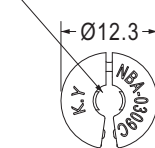

MOUNTING HOLE $\varnothing 9.5$
THICKNESS 0.6~3.2

Part No.	Package
NBA-0309C	1000

FOR $\varnothing 5.6$ CABLE

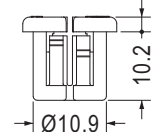
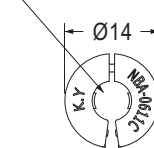

MOUNTING HOLE $\varnothing 11.1$
THICKNESS 0.6~3.2

Part No.	Package
NBA-0611C	1000

FOR $\varnothing 5.6$ CABLE

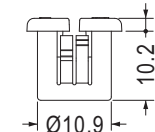
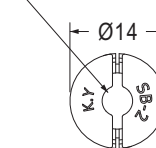

MOUNTING HOLE $\varnothing 11.1$
THICKNESS 0.6~3.2

Part No.	Package
SB-2	1000

開口式護線環 SNAP BUSHING

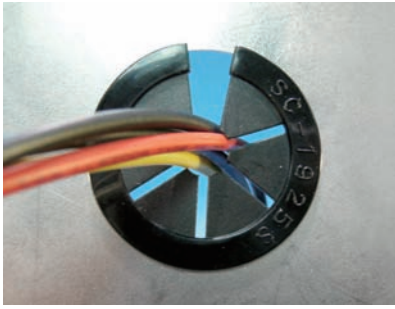

- Material: Nylon 66 (UL)
- Flame Class: 94V-2/94V-0
- Color: Black
- Unit: mm
- 採開口式量法

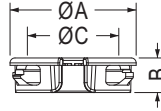

MOUNTING HOLE: $\varnothing G$
THICKNESS: T

[SC-1421S, SC-1422S]

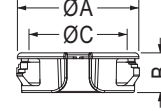
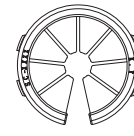

MOUNTING HOLE: $\varnothing G$
THICKNESS: T

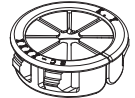

CLOSE

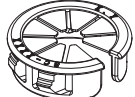

OPEN

RU
E127489

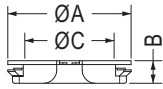
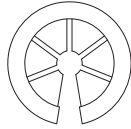

MOUNTING HOLE: $\varnothing G$
THICKNESS: T

RU
E127489

Part No.	A	B	C	G	T	Package
SC-1925S	29.0	5.3	21.0	25.4	0.8~1.0	250
SC-1925A	29.0	11.4	21.0	25.4	0.8~3.0	
SC-1319A	22.6	9.75	15.3	19.0	0.8~3.2	500

Part No.	A	B	C	G	T	Package
SC-0712	15.3	9.8	10.3	12.7	0.8~3.3	1000
SC-1115	18.8	10.3	13.8	15.9	0.8~3.3	
SC-1421S	24.5	8.9	17.85	21.0	0.6~1.6	250
SC-1422	25.5	10.3	18.5	22.2	0.8~3.3	
SC-1422S	25.5	7.0	18.5	22.2	0.6~1.2	200
SC-2027	31.5	10.3	25.5	27.8	0.8~3.3	
SC-2331	38.7	10.3	29.3	31.8	0.8~3.3	
SC-2534	39.2	10.3	31.2	34.9	0.8~3.3	
SC-2638	42.6	10.7	32.6	38.1	0.8~3.3	

護線環 SNAP BUSHING



- Material: Nylon 66 (UL)
- Flame Class: 94V-2/94V-0
- Color: Black
- Unit: mm

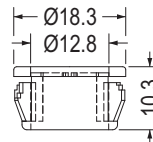

MOUNTING HOLE $\varnothing 15.9$
THICKNESS 3.2

RU
E127489

Part No.	Package
SC-1216	1000

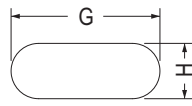
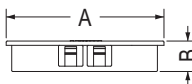
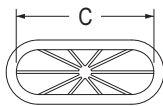

MOUNTING HOLE
THICKNESS: T

[NBR-7026, NBR-5520]

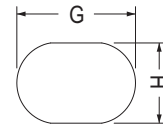
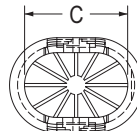

MOUNTING HOLE
THICKNESS: T

RU
E127489

Part No.	A	B	C	G	H	T	Package
NBR-3025	34.0	6.5	26.7	30.5	25.0	0.8~1.5	250
NBR-3725	41.5	14.3	32.2	37.0	25.0	1.2~3.0	
NBR-5030S	54.2	7.5	44.9	50.0	30.0	0.8~1.6	100
NBR-5030	54.2	14.3	44.9	50.0	30.0	1.2~3.0	
NBR-5520	59.2	14.3	49.9	55.0	20.0	1.2~3.2	
NBR-7026	74.2	14.3	64.7	70.0	26.0	1.2~3.2	
NBR-8054	84.5	14.3	71.4	80.0	54.0	1.2~3.0	

用途：用於機殼的電線出線口，保護電線不受機殼刮傷，裝配容易。

護線環 SNAP BUSHING

用途：用於機殼的電線出線口，保護電線不受機殼刮傷，裝配容易。



- Material: Nylon 66 (UL)
- Flame Class: 94V-2/94V-0
- Color: Black
- Unit: mm

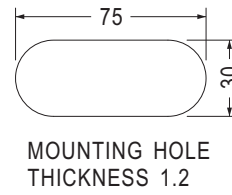
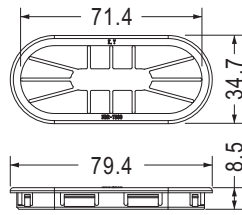

MOUNTING HOLE THICKNESS 1.2

Part No.	Package
NBR-7530	100

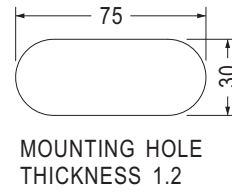
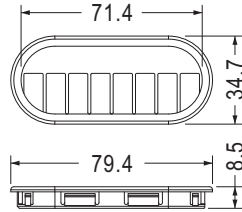

MOUNTING HOLE THICKNESS 1.2

Part No.	Package
NBR-7530-2	100

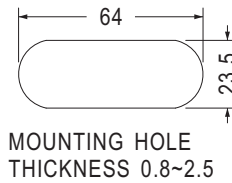
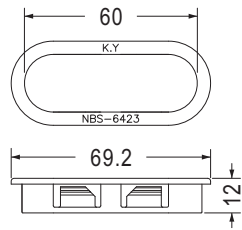

MOUNTING HOLE THICKNESS 0.8~2.5



Part No.	Package
NBS-6423	100

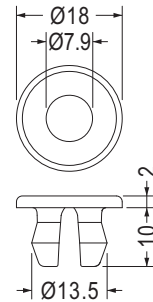

MOUNTING HOLE Ø12.0 THICKNESS 4.6

Part No.	Package
SBA-1	1000

線環 GROMMET

用途：用於電線之絕緣。



- Material: POM (UL)
- Flame Class: 94HB
- Color: Natural
- Unit: mm

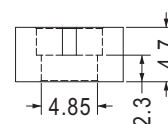
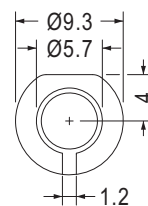

Part No.	Package
010406	2000

橡膠線環 GROMMET

用途：用於機殼的電線出線口，保護電線不受機殼刮傷，裝配容易。



- Material: Rubber/Silicon Rubber
- Color: Black
- Unit: mm

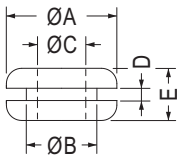
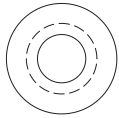

MOUNTING HOLE

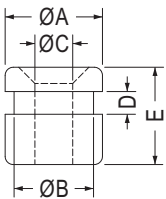
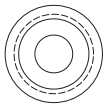

【 GM-16 】

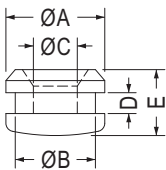
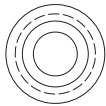

【 GM-17 】

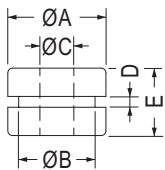
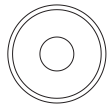

【 GM-38, GM-46, GM-71, GM-81 】

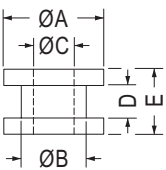
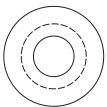

【 GM-40, GM-44, GM-55, GM-60, GM-65 】

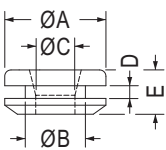
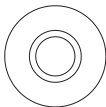

【 GM-45 】

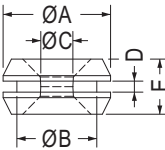
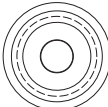

【 GM-49, GM-98 】

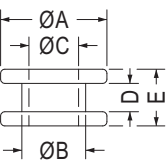

【 GM-53 】

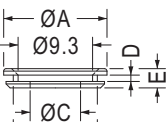

【 GM-64 】

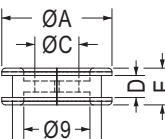

【 GM-68 】

Part No.	A	B	C	D	E	Package
GM-1	8.0	4.8	3.2	1.6	6.4	2000
GM-1A	9.5	6.4	4.0	1.6	6.4	
GM-2	10.8	8.0	4.5	1.6	4.5	
GM-3	14.4	9.5	6.3	1.6	7.0	1000
GM-3A	14.2	11.0	8.0	1.6	4.8	
GM-4	17.5	12.7	9.5	1.6	6.8	
GM-5	22.0	17.5	14.2	1.6	4.8	
GM-6	22.0	19.0	16.0	1.6	5.5	500
GM-6A	25.0	19.5	18.0	1.6	6.0	
GM-7	31.4	25.2	18.5	1.6	8.0	250
GM-8	19.5	14.0	6.0	1.0	7.0	1000
GM-9	15.9	12.7	9.5	1.6	6.4	
GM-11	7.9	4.8	3.2	1.6	4.8	2000
GM-14	17.46	11.11	7.94	2.38	8.73	500
GM-15	10.8	8.0	5.0	1.6	4.5	2000
GM-16	18.0	14.7	7.0	4.2	18.0	250
GM-17	18.0	14.6	8.0	3.8	12.0	500
GM-18	13.0	8.4	5.5	3.3	6.3	1000
GM-30	13.3	9.0	5.8	2.0	6.2	
GM-38	10.4	8.1	3.6	1.15	7.15	500
GM-40	24.0	17.5	14.0	3.0	7.0	
GM-42	27.0	20.8	12.7	1.6	7.8	250
GM-43	11.0	7.9	4.7	1.6	6.0	1000
GM-44	12.3	8.0	5.0	4.0	8.0	
GM-45	16.0	9.5	6.2	2.0	7.0	2000
GM-46	7.5	6.0	3.5	1.0	5.0	
GM-47	17.5	13.5	10.0	2.0	7.0	1000
GM-48	10.8	8.0	4.5	1.2	4.5	2000
GM-49	7.8	5.8	2.33	0.8	4.0	
GM-50	17.5	12.0	10.0	2.0	6.8	1000
GM-51	12.0	9.0	6.5	1.5	5.5	
GM-53	7.5	4.5	3.5	2.0	4.0	2000
GM-55	7.0	6.0	3.5	1.0	5.0	
GM-56	7.7	5.0	3.1	1.3	2.8	
GM-57	8.8	6.0	4.1	2.5	7.0	
GM-58	11.0	9.0	6.0	2.5	6.6	1000
GM-60	7.0	6.0	3.5	1.0	3.0	
GM-61	17.5	12.7	9.0	1.6	6.8	2000
GM-62	17.5	12.7	8.6	1.6	6.8	
GM-64	12.9	10.5	6.3	0.8	2.4	1000
GM-65	24.0	18.0	14.0	3.0	7.0	
GM-68	15.0	12.1	6.0	3.0	5.0	1000
GM-71	8.0	6.0	4.1	1.1	3.4	2000
GM-81	12.0	9.0	6.0	1.0	9.0	1000
GM-98	7.8	5.8	2.33	1.2	4.0	2000
GM-138	15.9	11.1	7.9	1.6	7.1	1000
GM-163	13.5	9.5	6.3	1.6	7.0	
GM-173	16.0	12.0	10.0	2.0	5.5	
GM-177	10.1	7.0	5.0	1.5	4.8	

橡膠線環 GROMMET

用途：用於機殼的電線出線口，保護電線不受機殼刮傷，裝配容易。



- Material: Rubber/Silicon Rubber
- Color: Black
- Unit: mm

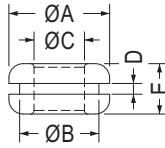
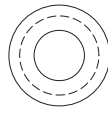

【 GM-69, GM-80, GM-147 】

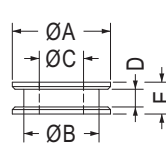
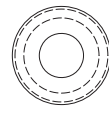

【 GM-99 】

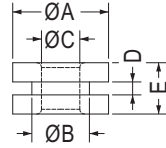
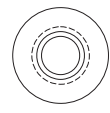

【 GM-106 】

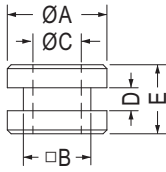

【 GM-154 】

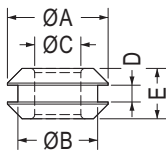
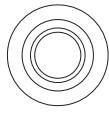

【 GM-159 】

Part No.	A	B	C	D	E	Package
GM-69	12.0	9.0	6.0	1.5	7.0	1000
GM-80	14.0	11.0	7.0	1.5	7.0	
GM-99	11.1	8.5	5.0	2.0	3.6	2000
GM-106	10.0	6.0	4.0	1.35	5.35	1000
GM-147	14.0	11.0	6.1	1.5	7.0	
GM-154	13.0	8.8	6.3	3.0	9.0	
GM-159	4.8	3.8	2.2	0.8	2.4	

5

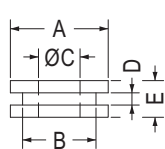
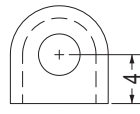

【 GM-35 】

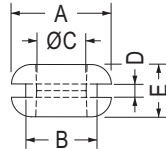
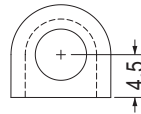

【 GM-39 】

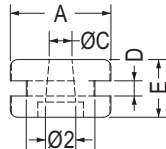
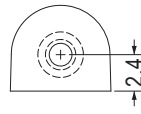

【 GM-70 】

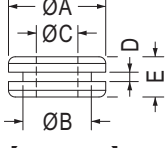
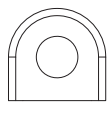

【 GM-137 】

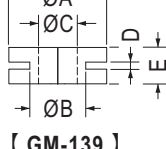

【 GM-139 】

Part No.	A	B	C	D	E	Package
GM-35	8.0	6.0	3.4	1.0	3.0	2000
GM-39	10.5	7.5	5.2	1.4	5.5	1000
GM-70	6.63	4.52	1.5	1.0	3.8	2000
GM-137	14.5	10.2	6.2	1.4	6.0	1000
GM-139	14.0	8.0	5.5	1.0	5.2	

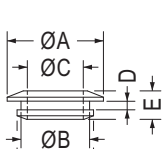
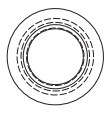

【 GM-136 】

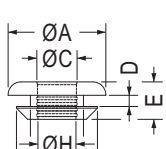
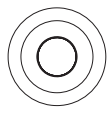

Part No.	A	B	C	D	E	F	H	Package	
GM-67	17.5	9.5	7.2	2.0	6.7	14.5	6.8	1000	
GM-73	17.5	9.5	6.8	2.0	6.7	14.5	6.3		
GM-74	18.5	10.5	8.2	2.0	6.7	15.5	7.8		
GM-75	19.5	11.5	9.2	2.0	6.7	16.5	8.8		
GM-77	21.8	13.8	10.8	2.0	6.7	18.8	10.8		
GM-82	17.5	9.5	6.2	2.0	6.7	14.5	5.8		
GM-96	17.5	11.5	7.2	2.0	6.7	16.5	6.8		
GM-97	17.5	11.5	7.6	2.0	6.7	16.5	7.2		
GM-136	12.0	8.5	6.7	1.1	3.6	9.5			2000

橡膠線環 GROMMET

用途：用於機殼的電線出線口，保護電線不受機殼刮傷，裝配容易。



- Material: Rubber/Silicon Rubber
- Color: Black
- Unit: mm

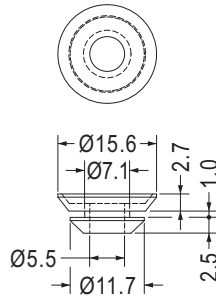

Part No.	Package
GM-158	1000



裝配孔尺寸，僅供參考
Mounting holes are for reference only.

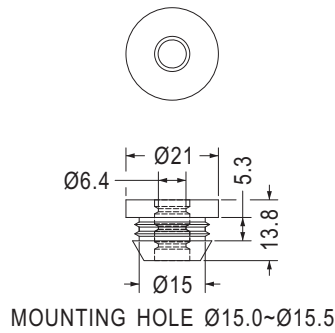

Part No.	Package
TF-346	500

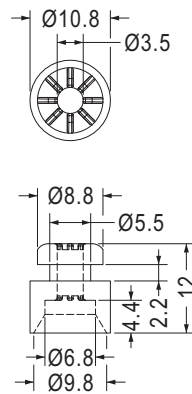

Part No.	Package
GM-92	1000



- Material: Silicon Rubber
- Color: Black
- Unit: mm

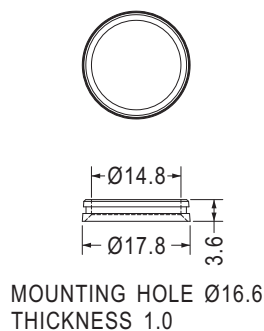

Part No.	Package
TF-1750	1000

橡膠線環 GROMMET

用途：用於機殼的電線出線口，保護電線不受機殼刮傷，裝配容易。

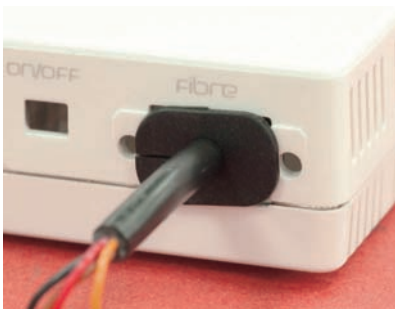

- Material: Silicon Rubber
- Color: Black
- Unit: mm

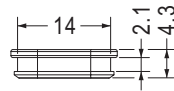
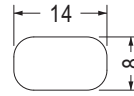
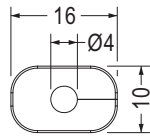

MOUNTING HOLE THICKNESS 2.0

Part No.	Package
TF-1333	1000

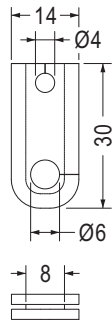

MOUNTING HOLE THICKNESS 1.0

Part No.	Package
GM-140	1000

5



- Material: Silicon Rubber (UL)
- Flame: 94V-0
- Color: Black
- Unit: mm

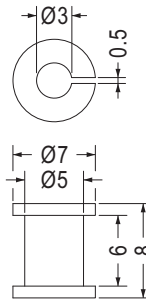

Part No.	Package
TF-1654	2000

導電護線環 CONDUCTIVE BUSHING

用途：用於機殼的電線出線口，保護電線不受機殼刮傷，裝配容易。



- Material: Silicon Rubber(UL)
- Flame: 94V-0
- Color: Black
- Unit: mm

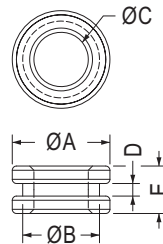

Part No.	A	B	C	D	E	Package
STGM-1	8.15	6.0	4.0	0.8	3.8	2000
STGM-2	7.0	5.5	3.9	0.9	3.4	

抗震線環 ANTI-VIBRATION GROMMET

用途：用於硬碟及精密零件之防震。
G: 為45度硬度，H: 為55度硬度

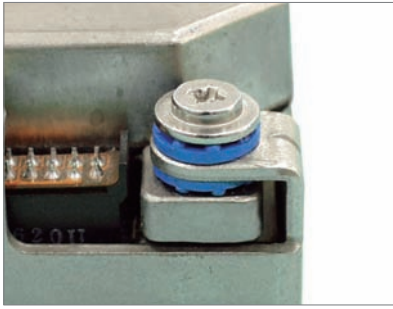

- Material: TPE (UL 94V-0 is optional)
G: Hardness is Shore A45
H: Hardness is Shore A55
- Color: Black/Blue
- Unit: mm

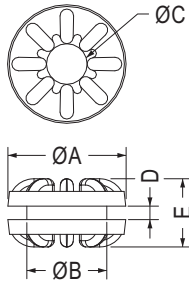

• TGM-128可配合TGM-128A螺絲用

Part No.	A	B	C	D	E	Package
TGM-14	14.0	9.5	4.85	1.6	8.1	1000
TGM-15	14.0	11.0	4.85	1.6	8.1	
TGM-16	14.0	9.5	4.85	1.0	7.5	
TGM-25	14.0	9.5	4.85	1.0	8.1	
TGM-29	14.0	9.5	4.85	1.2	7.4	
TGM-128	14.3	9.52	4.78	1.65	8.2	

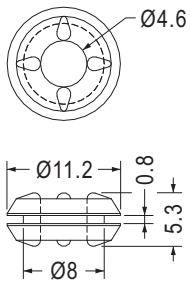

• TGM-11可配合TGM3-10和TGM632-10螺絲用

Part No.	Package
TGM-11	1000

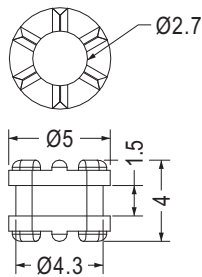

• TGM-17可配合TGM-17SW螺絲用

Part No.	Package
TGM-17	2000

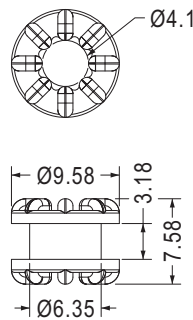

Part No.	Package
TGM-18	1000

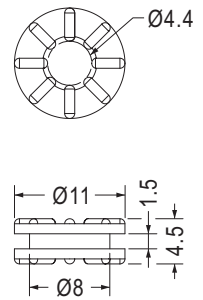

• Material: Silicon Rubber

Part No.	Package
TGM-21	2000

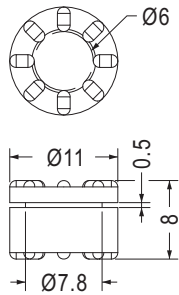

Part No.	Package
TGM-38	2000

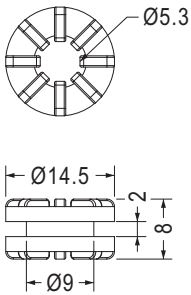

Part No.	Package
TGM-40	1000

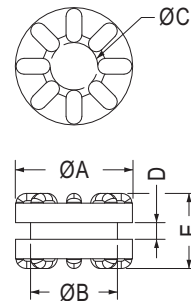

• TGM-10可配合TGM-10SW和TGM3-8SW螺絲用
• TGM-13可配合TGM-13SW螺絲用

Part No.	A	B	C	D	E	Package
TGM-10	9.62	6.3	3.9	1.6	5.8	1000
TGM-13	10.5	7.8	4.75	1.5	6.75	
TGM-22	9.62	6.3	3.9	3.0	7.0	
TGM-23	11.0	7.8	4.75	1.0	8.0	
TGM-24	9.62	6.3	3.9	1.0	5.8	
TGM-28	9.62	6.3	3.9	1.2	5.8	
TGM-42	12.0	9.0	6.0	1.0	9.0	
TGM-52	9.62	6.35	3.9	0.8	5.8	
TGM-82	9.5	7.0	4.3	2.6	6.6	
TGM-129	9.0	6.0	4.0	1.3	3.7	
TGM-151	9.2	6.5	4.1	1.0	4.6	
TGM-153	7.8	6.0	4.0	1.1	4.5	
TGM-161	19.0	13.8	9.0	3.0	10.2	
TGM-162	7.0	5.5	3.9	1.0	5.8	
TGM-163	10.5	7.8	4.75	2.0	7.25	
TGM-167	8.0	5.5	3.9	0.8	3.4	
★TGM-182	11.0	8.0	6.0	2.0	6.0	

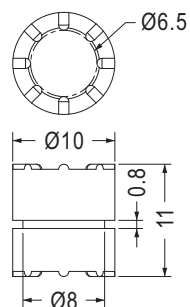

Part No.	Package
TGM-41	1000

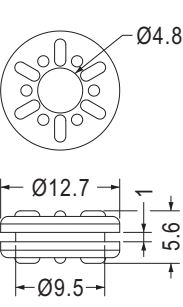

Part No.	Package
TGM-64	1000

抗震線環 ANTI-VIBRATION GROMMET

用途：用於硬碟及精密零件之防震。
G: 為45度硬度，H: 為55度硬度



- Material: TPE (UL 94V-0 is optional)
G: Hardness is Shore A45
H: Hardness is Shore A55
- Color: Black/Blue
- Unit: mm

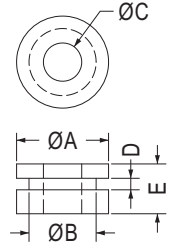
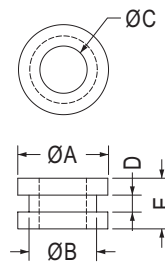

【 TGM-46, TGM-86, TGM-97 】

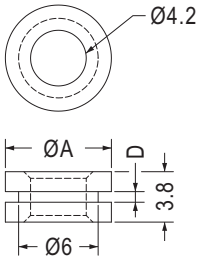

Part No.	A	D	Package
TGM-36	8.0	0.8	1000
TGM-164	8.5	1.1	

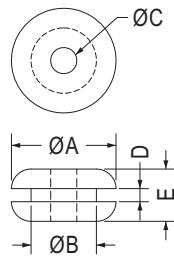

Part No.	A	B	C	D	E	Package
TGU-1	12.0	9.0	6.0	1.0	9.0	1000
TGM-20	8.0	6.0	4.2	1.5	4.6	
TGM-46	7.0	5.5	4.0	0.6	5.5	
TGM-86	9.6	7.0	4.0	1.2	5.2	
TGM-97	8.0	6.0	4.2	0.8	2.9	
TGM-116	10.0	7.0	5.0	2.0	5.0	
TGM-131	8.8	6.6	3.6	0.8	3.8	
TGM-137	8.8	6.0	4.2	0.9	2.9	
TGM-143	8.0	6.0	4.2	0.9	2.9	
TGM-145	9.6	7.6	5.6	0.8	2.8	
TGM-146	6.5	5.0	4.0	1.0	3.8	
TGM-170	7.5	5.8	3.1	0.9	2.8	
TGM-177	24.0	18.0	14.0	3.0	7.0	

Part No.	A	B	C	D	E	Package
TGM-171	8.0	5.0	2.0	1.0	4.0	2000
TGM-180	16.0	12.0	10.0	3.0	8.0	1000
TGM-181	31.5	25.0	18.5	1.6	8.0	250
GM-131	30.0	25.5	22.0	1.6	8.0	

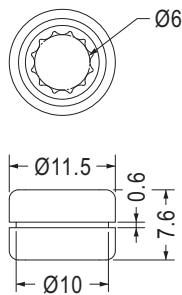
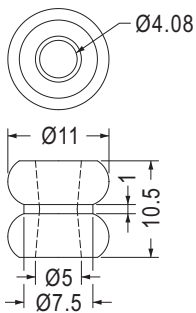
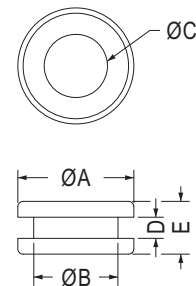

Part No.	Package
TGM-51	1000

Part No.	Package
TGM-45	1000

Part No.	A	B	C	D	E	Package
TGM-44	11.0	8.0	6.0	2.0	5.0	1000
TGM-50	7.0	5.5	3.9	0.9	2.8	
TGM-56	12.7	9.5	4.8	1.6	5.4	
TGM-81	14.2	9.5	4.9	1.0	4.9	
TGM-130	14.2	9.5	5.4	1.0	4.9	
TGM-138	8.6	7.0	5.5	0.8	7.8	
TGM-175	8.8	6.8	4.85	1.2	4.0	

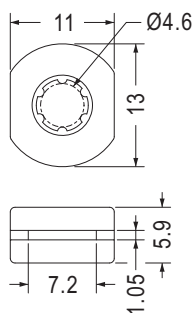
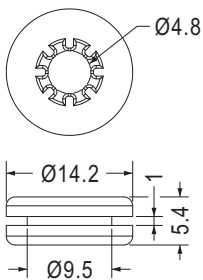

Part No.	Package
TGM-65	1000

Part No.	Package
TGM-173	1000

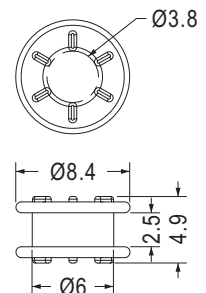
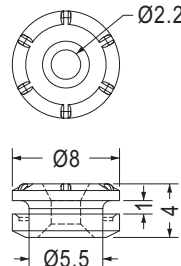

• Material: Silicon Rubber

Part No.	Package
TGM-68	2000

Part No.	Package
TGM-83	1000

抗震線環 ANTI-VIBRATION GROMMET

用途：用於硬碟及精密零件之防震。
G: 為45度硬度，H: 為55度硬度

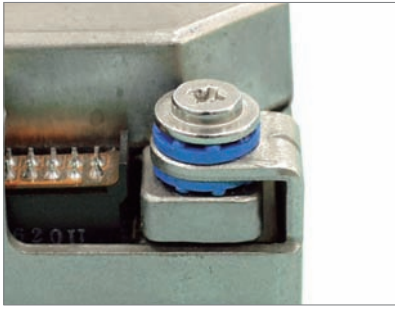

裝配孔尺寸，僅供參考
Mounting holes are for reference only.

- Material: TPE (UL 94V-0 is optional)
G: Hardness is Shore A45
H: Hardness is Shore A55
- Color: Black/Blue
- Unit: mm

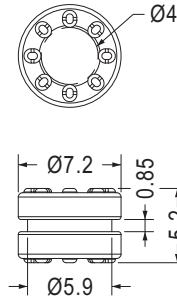

Part No.	Package
TGM-166	1000

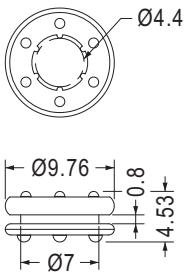

MOUNTING HOLE Ø7.0~Ø7.5

Part No.	Package
TGM-71	1000

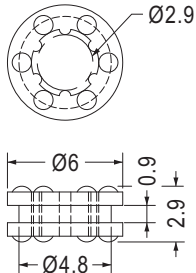

• Material: Silicon Rubber

Part No.	Package
TGM-124	1000

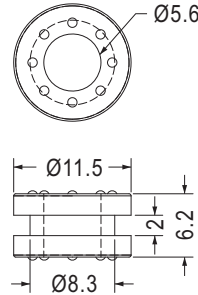

Part No.	Package
TGM-140	1000

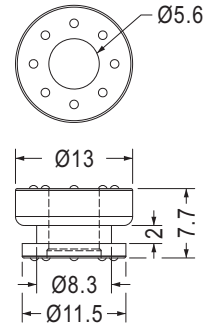

Part No.	Package
TGM-149	1000

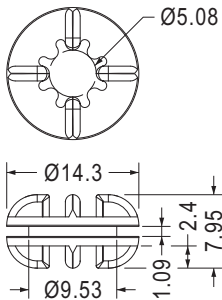

Part No.	Package
TGM-141	1000

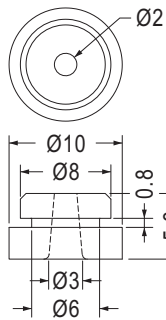

Part No.	Package
TGM-49	1000

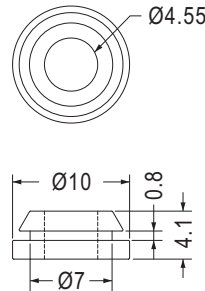

Part No.	Package
TGM-174	1000

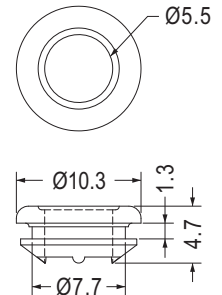

Part No.	Package
TGM-123	2000

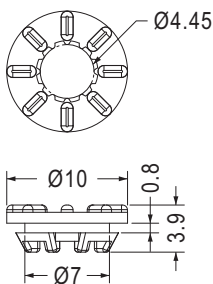

Part No.	Package
TGM-88	1000

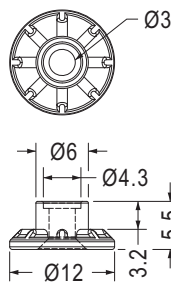

MOUNTING HOLE Ø6.0

Part No.	Package
TGM-76	1000

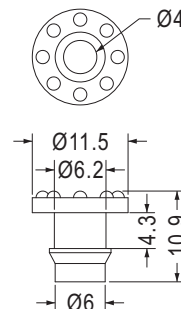

Part No.	Package
TGM-67	1000

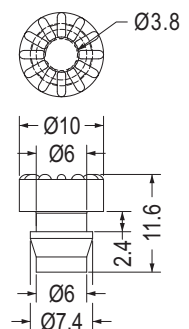

Part No.	Package
TGM-152	1000

墊片 WASHER

用途：風扇螺絲墊片抗震性良好。

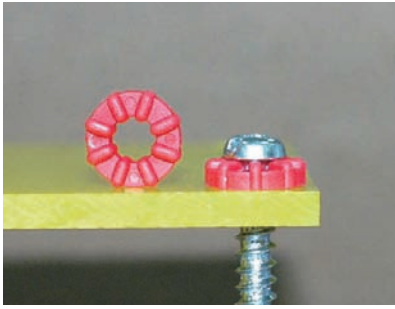

- Material: TPE
- Color: Black/Red
- Unit: mm

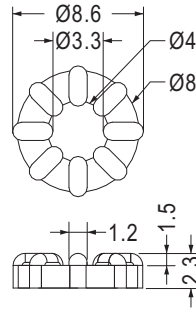

Part No.	Package
WSQ4-2	2000

抗震線環 ANTI-VIBRATION GROMMET

用途：用於硬碟及精密零件之防震。
G: 為45度硬度，H: 為55度硬度



- Body Material: TPE (UL 94V-0 is optional)
- G: Hardness is Shore A45
- H: Hardness is Shore A55
- Pin Material: Zinc Plated Steel
- Color: Black
- Unit: mm

裝配孔尺寸，僅供參考
Mounting holes are for reference only.

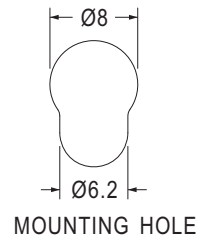
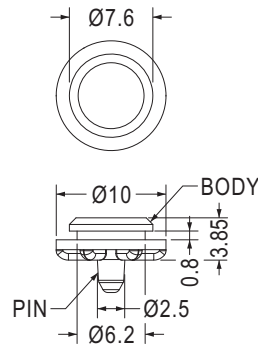

Part No.	Package
TGM-96	1000

5



- Body Material: TPE
- Pin Material: Zinc Plated Steel
- Color: Black/Blue
- Unit: mm

裝配孔尺寸，僅供參考
Mounting holes are for reference only.

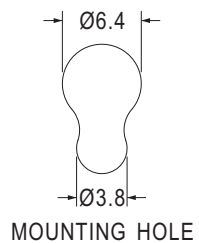
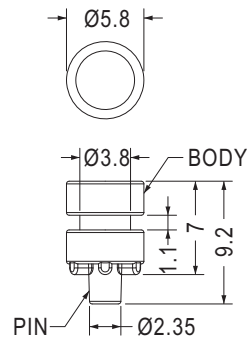

- TGM-117為專利品
- TGM-117 is patented

Part No.	Package
TGM-73	1000
TGM-117	

抗震線環 ANTI-VIBRATION GROMMET

用途：用於硬碟及精密零件之防震。



裝配孔尺寸，僅供參考
Mounting holes are for reference only.

- Body Material: TPE
- Pin Material: Zinc Plated Steel
- Color: Black/Blue
- Unit: mm

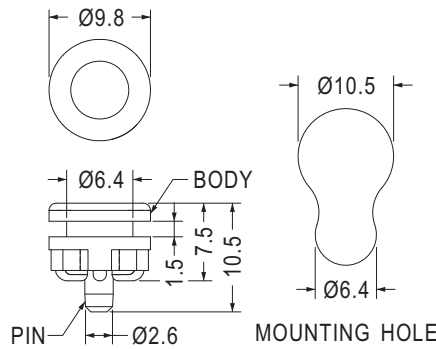

Part No.	Package
TGM-74	1000

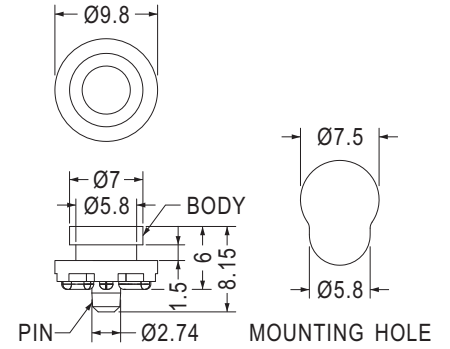

Part No.	Package
TGM-126	1000

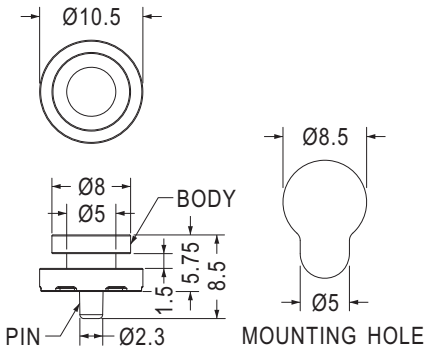

Part No.	Package
TGM-132	1000

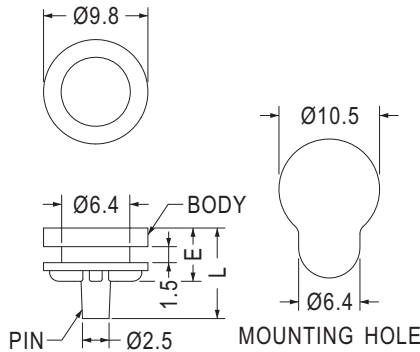

Part No.	E	L	Package
TGM-58	5.0	8.5	1000
TGM-112	5.5	9.0	

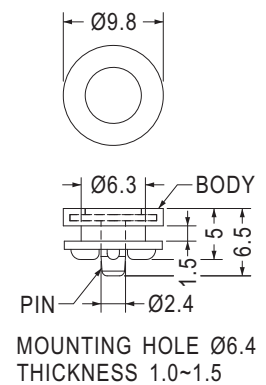

Part No.	Package
TGM-176	1000



裝配孔尺寸，僅供參考
Mounting holes are for reference only.

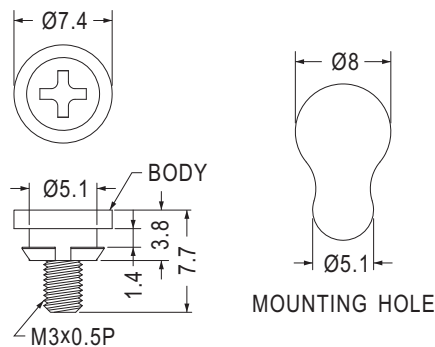

Part No.	Package
TGM-69	1000

螺絲 SCREW

用途：硬碟及精密零件之抗震線環用螺絲，可配抗震線環使用。



- Material: Steel
- Finish: Nickel Plating
- Unit: mm

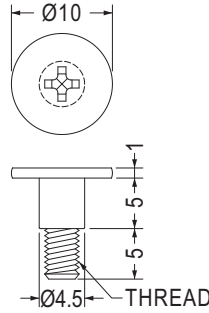

• 可配抗震線環TGM-11使用

Part No.	Thread	Package
TGM3-10	M3x0.5	1000
TGM632-10	6-32 UNC	

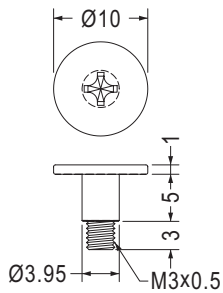

• 可配抗震線環TGM-10使用

Part No.	Package
TGM3-8SW	1000

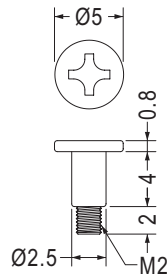

• 可配抗震線環TGM-17使用

Part No.	Package
TGM-17SW	2000

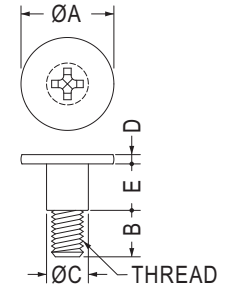
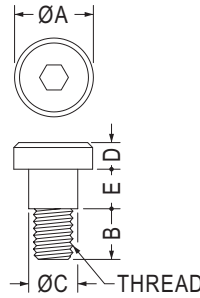

[TGM3-9.8SW]

Part No.	A	B	C	D	E	Thread	Package
TGM3-9.8SW	10.0	3.4	4.8	1.0	6.4	M3x0.5	1000
TGM3-11SW	6.0	4.0	4.0	3.0	4.01		
TGM4-11SW	8.0	5.15	5.0	2.7	4.01	M4x0.7	
TGM4-14SW	8.0	7.8	5.0	2.7	4.0		

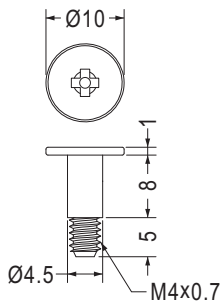

Part No.	Package
TGM4-13ST-1	1000

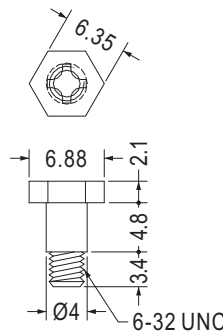

• 可配抗震線環TGM-10使用

Part No.	Package
TGM-10SW	1000

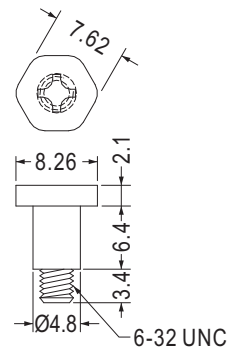

• 可配抗震線環TGM-13使用

Part No.	Package
TGM-13SW	1000

插銷 PIN

用途：硬碟及精密零件之抗震線環用插銷，可配抗震線環TGM-128使用。



- Material: PC (UL)
- Flame Class: 94V-0
- Color: Black
- Unit: mm
- Patented (專利品)

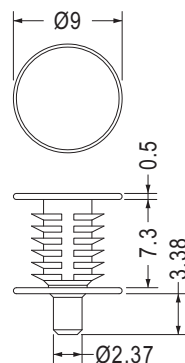

Part No.	Package
TGM-128A	1000

抗震線環 ANTI-VIBRATION GROMMET

用途：用於硬碟及精密零件之防震。



- Material: NBR/Rubber/Silicon Rubber
- Color: Black
- Unit: mm

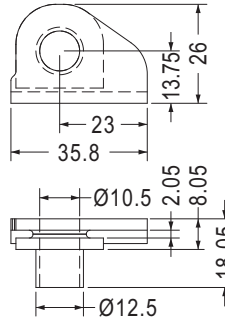

Part No.	Package
GM-25	1000

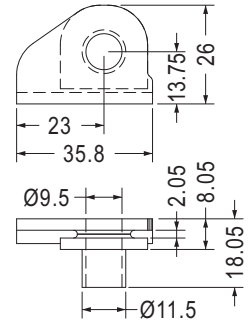

Part No.	Package
GM-26	1000

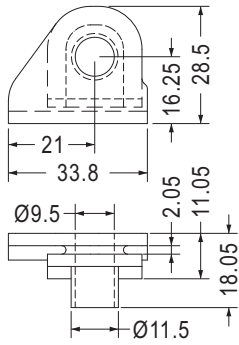

Part No.	Package
GM-27	1000

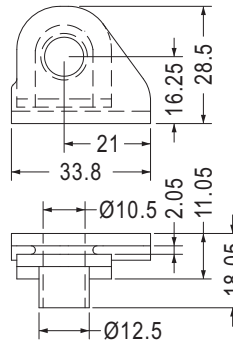

Part No.	Package
GM-28	1000

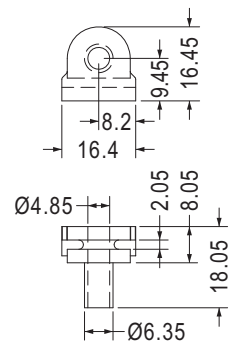

Part No.	Package
GM-31	1000

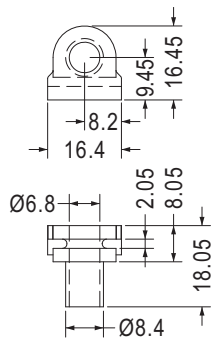

Part No.	Package
GM-32	1000

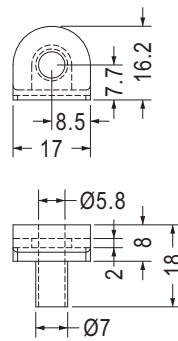

Part No.	Package
GM-33	250

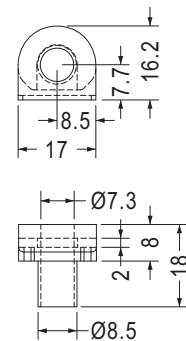

Part No.	Package
GM-34	250

磁碟機防震座 HDD ANTI-VIBRATION BASE

用途：用於磁碟機之防震保護。



- Material: TPE
- Color: Black
- Unit: mm

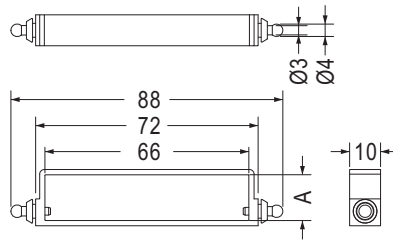

Part No.	A	HDD	Package
DKHR-1	14.8	3.5"	250
DKHR-7	6.7	2.5"	100
DKHR-9	9.3		

護線環 SNAP BUSHING

用途：用於機殼的電線出線口，保護電線不受機殼刮傷，裝配容易。



- Material: TPE
- Color: Black
- Unit: mm

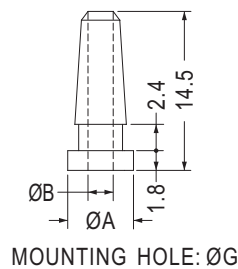

Part No.	A	B	G	Package
LGT-2	6.0	2.3	4.0	1000
LGT-6G	7.0	3.0	4.8	

5

矽膠護線環 SILICON SNAP BUSHING

用途：用於機殼的電線出線口，保護電線不受機殼刮傷，裝配容易。



- Material: Silicon Rubber
- Color: Black
- Unit: mm

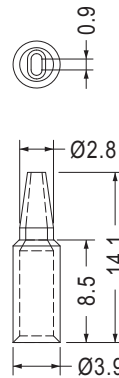

Part No.	Package
TF-395	1000

天線護線環 ANTENNA SNAP BUSHING

用途：用於天線之絕緣與保護。

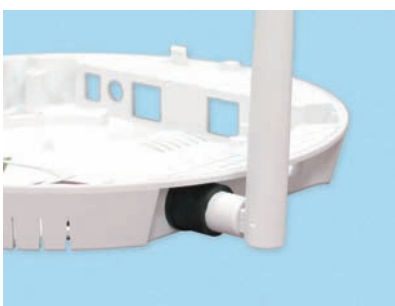

- Material: Silicon Rubber
- Color: White/Black
- Unit: mm

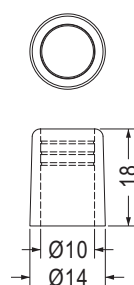

Part No.	Package
ANTCV-2	500

扣式塞頭 HOLE PLUG

用途：可將多餘的機殼出線口遮蓋，裝配容易。



- Material: TPE (UL)
- Flame Class: 94V-0
- Color: Black
- Unit: mm

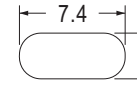
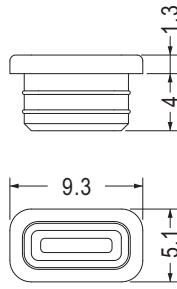

RECOMMEND MOUNTING HOLE

裝配孔尺寸，僅供參考
Mounting holes are for reference only.

Part No.	Package
MHDS-1	1000

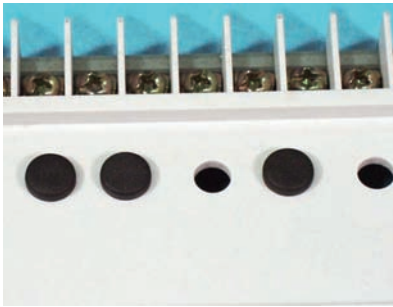

- Material: TPE/TPE (UL)
- Flame Class: 94V-0
- Color: Black
- Unit: mm

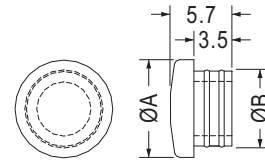

MOUNTING HOLE: ØG

裝配孔尺寸，僅供參考
Mounting holes are for reference only.

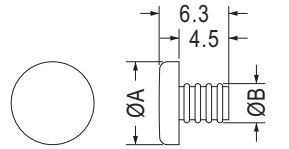

MOUNTING HOLE: ØG or M4
【 MHD-3.3 】

Part No.	A	B	G	Package
MHD-3.3	7.5	3.55	3.3	1000
MHD-4.5	6.0	4.7	4.5	
MHD-5	7.0	5.2	5.0	
MHD-5L	7.0	5.2	5.0	
MHD-5.5	7.0	5.6	5.5	
MHD-5.5I	7.0	5.6	5.5	
MHD-6	8.0	6.2	6.0	
MHD-6.5	8.0	6.9	6.5	
MHD-7	9.0	7.2	7.0	
MHD-7S	9.0	7.3	7.0	
MHD-7.5I	10.0	7.9	7.5	
MHD-8	10.0	8.2	8.0	
MHD-9	11.0	9.4	9.0	
MHD-10L	12.0	10.4	10.0	
MHD-17I	17.0	13.6	12.0	

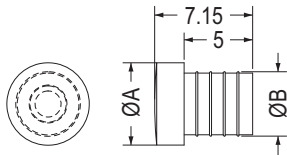

MOUNTING HOLE: ØG
【 MHD-4.5 】

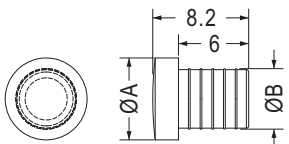

MOUNTING HOLE: ØG
【 MHD-5L 】

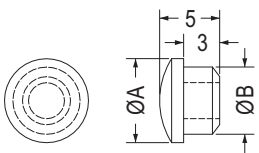

MOUNTING HOLE: ØG
【 MHD-5.5, MHD-5.5I 】

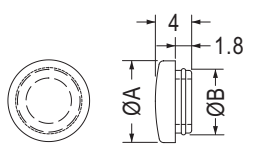

MOUNTING HOLE: ØG
【 MHD-7S 】

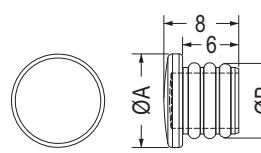

MOUNTING HOLE: ØG
• Material: Silicon Rubber
【 MHD-7.5I 】

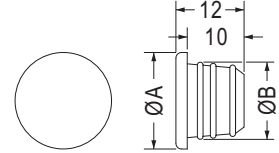

MOUNTING HOLE: ØG
• Material: Silicon Rubber
【 MHD-17I 】

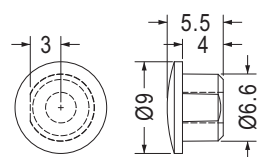

MOUNTING HOLE Ø6.35

- Material: Silicon Rubber

Part No.	Package
MHD-6.3I	1000

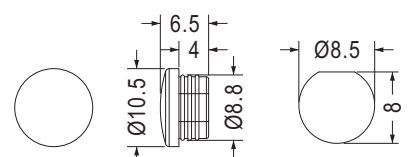

MOUNTING HOLE

Part No.	Package
MHD-16	1000

扣式塞頭 HOLE PLUG

用途：可將多餘的機殼出線口遮蓋，裝配容易。

- Material: Nylon 66 (UL)
- Flame Class: 94V-2/94V-0
- Color: Natural/Black
- Unit: mm

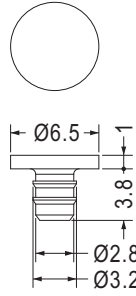

MOUNTING HOLE Ø3.0

Part No.	Package
MBH-1	1000

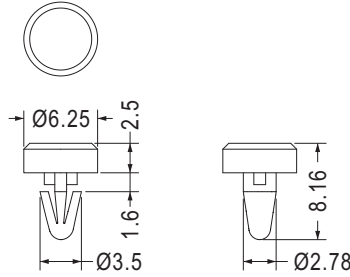

MOUNTING HOLE Ø2.8
THICKNESS 1.2

Part No.	Package
FIXE-1	1000

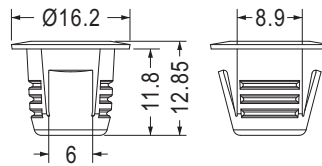

MOUNTING HOLE Ø12.0
CHASSIS THICKNESS 3.0

Part No.	Package
MHF-1	1000

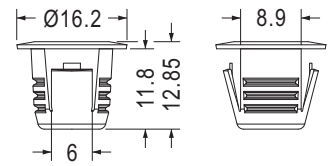

MOUNTING HOLE Ø12.0
CHASSIS THICKNESS 3.0

Part No.	Package
MHF-2	1000

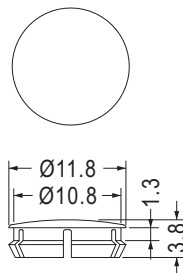

MOUNTING HOLE Ø11.0

Part No.	Package
MHE-11	1000

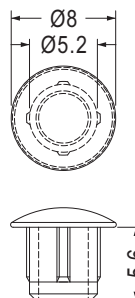

MOUNTING HOLE Ø5.5

Part No.	Package
MHCA5.5-5.6	2000

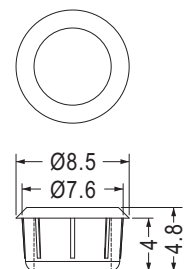

MOUNTING HOLE Ø7.5

Part No.	Package
MHC-1	2000

裝配孔尺寸，僅供參考
Mounting holes are for reference only.

扣式塞頭 HOLE PLUG

用途：可將多餘的機殼出線口遮蓋，裝配容易，輕微防水。



- Material: Nylon 66 (UL)/TPU
- Flame Class: 94V-2
- Color: Black
- Unit: mm

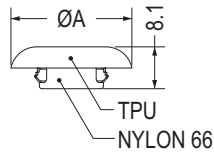
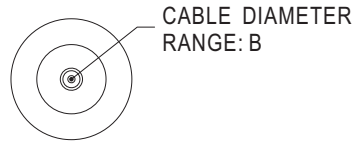

MOUNTING HOLE: ØG
THICKNESS 1.0~1.6

Part No.	A	B	G	Package
MBP-12.7	23.4	2.0~5.1	12.7	1000
MBP-15.9	26.2	3.3~9.5	15.9	
MBP-19.1	29.2	4.4~10.2	19.1	
MBP-22.2	32.5	3.3~11.4	22.2	500
MBP-25.4	36.3	5.1~18.2	25.4	
MBP-27.8	38.9	6.4~19.4	27.8	



- Material: Nylon 66 (UL)
- Flame Class: 94V-2/94V-0
- Color: Natural/Black
- Unit: mm

用途：可將多餘的機殼出線口遮蓋，裝配容易。

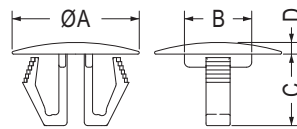

MOUNTING HOLE: ØG
THICKNESS: T

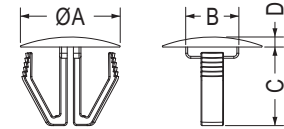

MOUNTING HOLE: ØG
THICKNESS: T

【 MBWK4-1 】

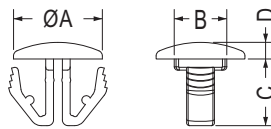

MOUNTING HOLE: ØG
THICKNESS: T

【 MBWK-8 】

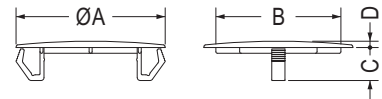

MOUNTING HOLE: ØG
THICKNESS: T

【 MBWK-7 】

Part No.	A	B	C	D	G	T	Package
MBWK-1	18.5	9.8	10.4	1.7	11.0~14.0	0.8~3.5	500
MBWK-2	30.0	15.5	11.6	1.9	22.0~26.0	0.8~3.5	
MBWK4-1	16.0	8.5	12.6	1.6	9.5~11.0	0.8~3.2	
MBWK-7	52.0	43.6	11.5	2.2	44.7~49.0	0.8~3.2	200
MBWK-8	8.0	4.7	6.0	1.5	5.0~6.0	0.8~1.6	500



- Material: POM
- Color: Black
- Unit: mm

- Material: POM (UL)
- Flame Class: 94HB

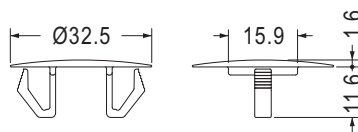

MOUNTING HOLE Ø22.0~Ø25.5
THICKNESS 0.8~3.2

Part No.	Package
MBWK-9	500

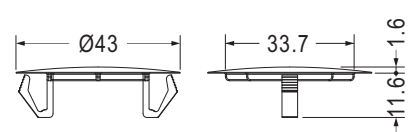

MOUNTING HOLE Ø35.0~Ø38.0
THICKNESS 0.8~3.2

Part No.	Package
★ MBWK-6	500

扣式塞頭 HOLE PLUG

用途：可將多餘的機殼出線口遮蓋，裝配容易。

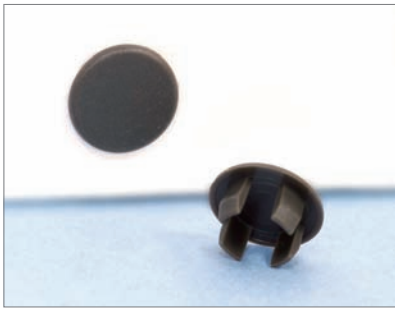

- Material: Nylon 66 (UL)
- Flame Class: 94V-2/94V-0
- Color: Natural/Black
- Unit: mm

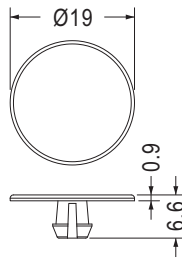

MOUNTING HOLE $\varnothing 4.75\sim\varnothing 5.1$
THICKNESS 3.3~3.5

Part No.	Package
MBT-14	1000

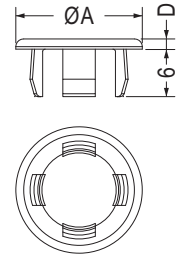

MOUNTING HOLE: $\varnothing G$
THICKNESS 0.8~3.8

Part No.	A	D	G	Package
MBPP-6	10.4	1.1	6.0	1000
MBPP-6.4	10.4	1.1	6.4	
MBPP-12	16.0	1.3	12.0	



- Material: TPE
- Color: Natural/Black
- Unit: mm

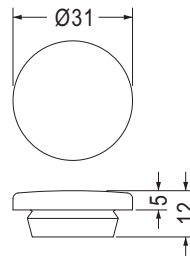

MOUNTING HOLE $\varnothing 22.0$
THICKNESS 0.8~2.0

Part No.	Package
CDELT-11	500

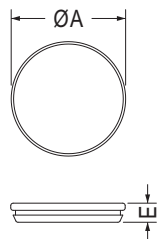

MOUNTING HOLE: $\varnothing G$
THICKNESS 0.8~1.0

Part No.	A	E	G	Package
CDELT-1	24.0	4.0	22.0	1000
CDELT-4	16.0	3.5	13.0	

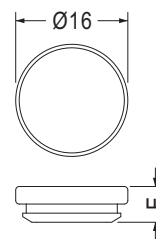

MOUNTING HOLE $\varnothing 13.0$
THICKNESS: T

Part No.	E	T	Package
CDELT-6	3.5	1.0	1000
CDELT-7	5.1	1.0~1.2	

- Material: TPE (UL)
- Flame Class: 94HB
- Color: Black
- Unit: mm

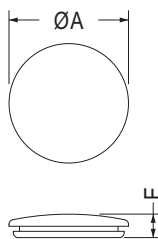

MOUNTING HOLE: $\varnothing G$
THICKNESS: T

Part No.	A	E	G	T	Package
CDELT-16	38.2	7.5	31.5	1.6	200
CDELT-17	18.7	5.6	12.7	1.6	1000
CDELT-18	43.7	8.2	38.2~38.5	1.5	200

- Material: TPE (UL)
- Flame Class: 94HB
- Color: Black
- Unit: mm

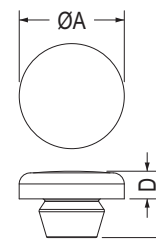

MOUNTING HOLE: $\varnothing G$
THICKNESS 0.8~2.0

Part No.	A	D	G	Package
CDELT-12	19.0	5.0	10.0	500
CDELT-13	25.0	5.0	16.0	
CDELT-14	39.0	5.5	30.0	200

扣式塞頭 HOLE PLUG

用途：可將多餘的電源線扣機殼出線口遮蓋，裝配容易。



- Material: Nylon 66 (UL)
- Flame Class: 94V-2/94V-0
- Color: Natural/Black
- Unit: mm

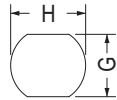
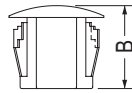
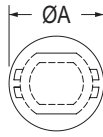

MOUNTING HOLE THICKNESS: T



Part No.	A	B	G	H	T	Package	UL
M9.5U	12.0	10.5	7.9	9.5	0.8~3.5	1000	UL
M11U	14.5	10.6	9.9	11.0	3.3		UL
M12U	16.2	10.6	11.5	12.7	0.8~3.0	500	UL
M14U	17.8	10.6	13.4	14.3	3.3		UL
M16U	18.6	10.6	14.0	15.9	0.8~3.5		UL
M19U	22.7	10.6	16.5	19.0	0.8~3.0		UL
M22U	25.6	10.6	20.5	22.1	0.8~3.3		UL
M28U	32.0	13.5	25.4	28.2	0.8~3.3	200	

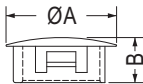
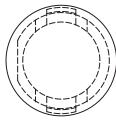

MOUNTING HOLE: ØG
THICKNESS: T

【 M13.5 】

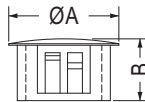
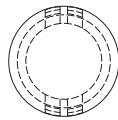

MOUNTING HOLE: ØG
THICKNESS: T

Part No.	A	B	G	T	Package
M04	6.35	5.5	4.8	1.6	2000
M05	6.4	6.0	5.0	0.6~2.0	1000
M06	7.6	5.6	6.4	1.6	2000
M07	10.9	7.0	7.0	0.8~1.8	
M07S	8.7	6.4	7.0	1.8	
M08	9.5	7.6	8.0	1.6	1000
M09A	11.5	10.1	9.0	3.3	
M09S	13.0	5.5	9.5	1.4	
M09	11.9	10.1	9.5	3.3	
M10	11.9	6.4	10.3	1.6	

Part No.	A	B	G	T	Package
M11	14.0	10.1	11.0	3.3	500
M12	14.3	10.1	12.0	3.3	
M13	14.6	10.1	12.7	3.3	
M13.5	15.2	6.2	13.5	2.2	
M14	16.3	10.1	14.0	3.3	
M15	17.3	10.1	15.0	3.3	
M16	18.7	10.6	16.0	3.3	1000
M16S	20.0	7.7	15.9	2.0	
M17	19.3	10.1	17.0	3.3	500
M19	23.2	10.3	19.0	3.3	
M20	24.0	10.6	20.0	3.3	
M22	25.4	11.0	22.2	3.3	
M25	28.4	11.0	25.4	3.3	200
M28	32.0	13.5	28.0	3.3	
M30	34.2	11.3	30.0	3.3	
M30L	34.0	11.8	30.1	0.8~3.2	
M32	36.0	12.0	32.0	3.3	
M35	38.1	11.5	35.0	3.2	
M38	42.4	11.8	38.1	3.2	
M44	48.4	11.8	44.5	3.2	
M50	56.4	17.0	50.8	6.4	100
M53	57.5	19.0	53.0	0.8~6.5	
M63	71.2	19.1	63.5	0.8~6.4	200

扣式塞頭 HOLE PLUG

用途：可將多餘的電源線扣機殼出線口遮蓋，裝配容易。



- Material: Nylon 66 (UL)
- Flame Class: 94V-2/94V-0
- Color: Natural/Black
- Unit: mm

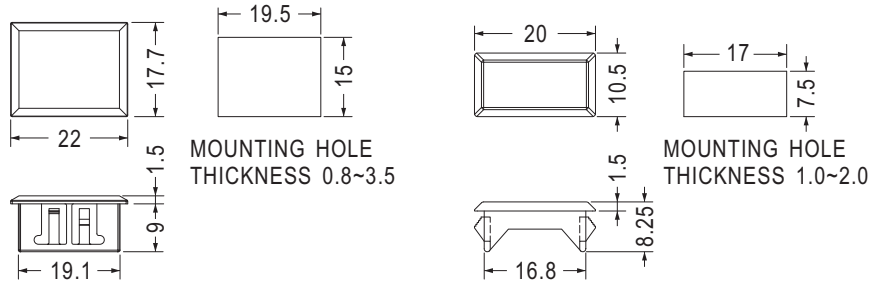

Part No.	Package
MSQ-14	500

Part No.	Package
MSQ-8	500

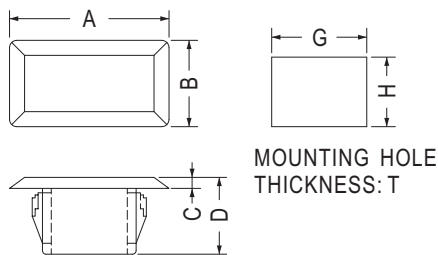

Part No.	A	B	C	D	G	H	T	Package
MSQ-1	21.8	11.8	1.5	10.5	13.0	9.5	0.8~3.5	500
MSQ-2	35.0	11.9	1.5	10.5	26.0	9.5	0.8~3.5	
MSQ-4	16.0	12.0	1.5	10.5	13.0	9.5	1.4~3.5	
MSQ-5	15.0	15.0	2.0	11.0	13.5	13.5	0.75~3.8	
MSQ-6	24.3	14.0	1.5	10.5	16.0	11.5	0.8~3.5	
MSQ-7	18.0	8.0	1.5	10.5	16.5	6.5	0.8~3.5	
MSQ-9	19.3	19.0	1.5	10.5	17.3	17.0	0.8~3.5	
MSQ-10	39.0	15.7	1.5	10.5	35.5	12.2	1.4~3.5	

塞頭 HOLE PLUG

用途：可將多餘的電源線扣機殼出線口遮蓋，裝配容易。



- Material: TPE/TPE (UL)
- Flame Class: 94HB
- Color: Black
- Unit: mm

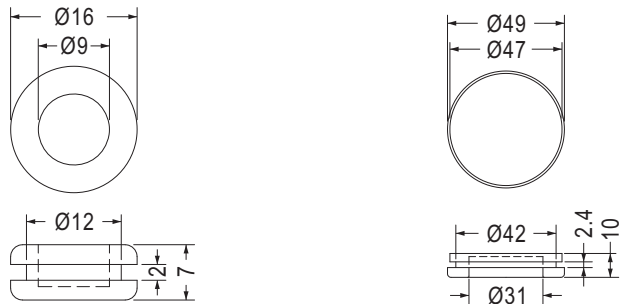

Part No.	Package
DGB-12	1000

Part No.	Package
DGB-42	100

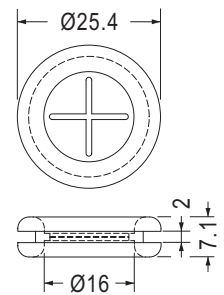
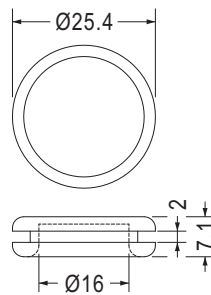
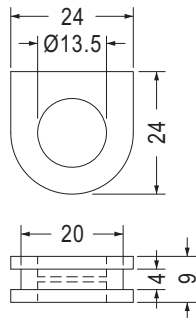
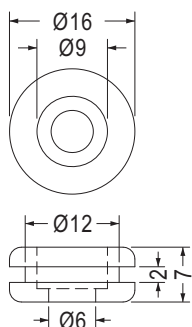

MOUNTING HOLE Ø19.0

MOUNTING HOLE Ø19.0

• Material: Rubber

• Material: Rubber

Part No.	Package
DGBD-12	1000

Part No.	Package
DGBE-1	500

Part No.	Package
DGB-19	500

Part No.	Package
DGB-19A	500

塞頭 HOLE PLUG

用途：可將多餘的電源線扣機殼出線口遮蓋，裝配容易。



裝配孔尺寸，僅供參考
Mounting holes are for reference only.

- Material: Rubber/Silicon Rubber/
Silicon Rubber (UL)
- Flame Class: 94V-0
- Color: Black
- Unit: mm

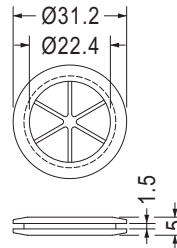

MOUNTING HOLE Ø25.4

Part No.	Package
DGB-25	500

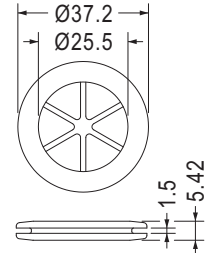

MOUNTING HOLE Ø28.5

Part No.	Package
DGB-26	500

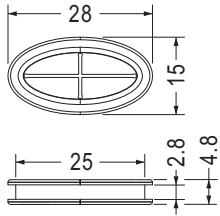

Part No.	Package
DGBB-1	1000

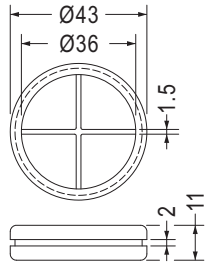

MOUNTING HOLE Ø40.0
THICKNESS 2.0

Part No.	Package
DGB-40	200

- Material: TPE (UL)/TPE
- Flame Class: 94HB

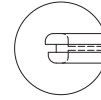

[GDBB-1]

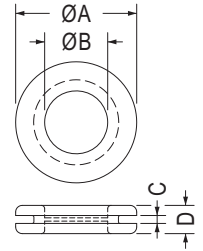

MOUNTING HOLE: ØG

Part No.	A	B	C	D	G	Package
GDBB-1	27.5	16.0	2.0	7.4	22.0	500
GDBB-2	36.5	19.0	2.4	8.5	25.5	250
★GDBB-3	53.0	35.5	2.5	10.0	47.0	500
★GDBB-4	24.0	13.5	2.0	7.0	20.0	500



裝配孔尺寸，僅供參考
Mounting holes are for reference only.

- Material: Silicon Rubber
- Color: Black
- Unit: mm

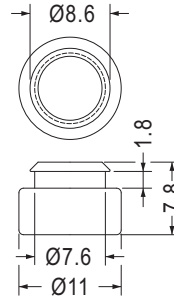

MOUNTING HOLE Ø7.0~Ø7.3
THICKNESS 1.0~1.5

Part No.	Package
TF-140	2000

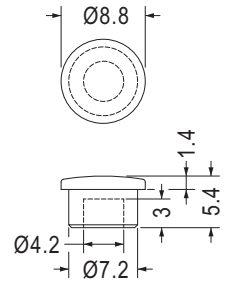

MOUNTING HOLE Ø7.0

Part No.	Package
TF-039	1000



裝配孔尺寸，僅供參考
Mounting holes are for reference only.

- Material: Silicon Rubber
- Color: Black
- Unit: mm

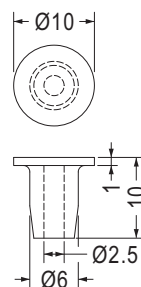

MOUNTING HOLE Ø5.5~Ø5.8

Part No.	Package
TF-618	2000

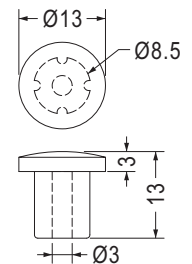

MOUNTING HOLE Ø8.3

Part No.	Package
TF-461	1000

塞頭 HOLE PLUG



裝配孔尺寸，僅供參考
Mounting holes are for reference only.

- Material: EPDM
- Color: Black
- Unit: mm

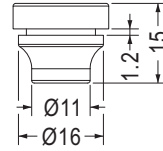

MOUNTING HOLE Ø11.5
THICKNESS 1.2~1.5

用途：做為電纜線出線口之輕微防水及固定。

Part No.	Package
TF-1643	1000



- Material: Silicon Rubber (UL)/ EPDM
- Flame Class: 94V-2
- Color: Black
- Unit: mm

用途：可將多餘的機殼出線口遮蓋，亦可將M3螺絲孔塞住。

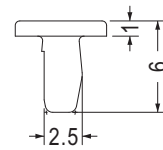
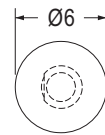

配合 M3 攻牙孔使用
FOR M3 TAPPED

Part No.	Package
TF-222	2000



裝配孔尺寸，僅供參考
Mounting holes are for reference only.

- Material: PE
- Color: Natural/Black
- Unit: mm

用途：用於電纜防水接頭之塞頭。

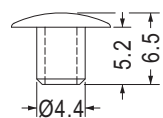
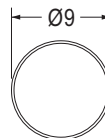

MOUNTING HOLE Ø4.0

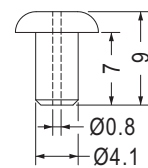
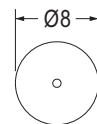

Part No.	Package
ACSRA-4.4	1000

Part No.	Package
ACSRC-4.1	2000

塞頭 HOLE PLUG

用途：用於電纜防水接頭之塞頭。



- Material: Nylon 66 (UL)
- Flame Class: 94V-2/94V-0
- Color: Natural/Black
- Unit: mm

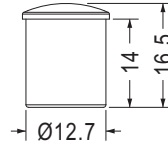
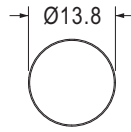

Part No.	Package
ACSRB-12.7	1000

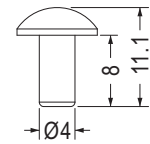
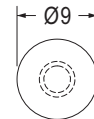
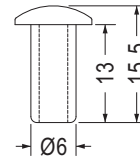
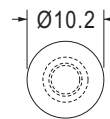

Part No.	Package
ACSRB-6	1000

Part No.	Package
ACSRA-4	1000



- Material: Nylon 66 (UL)
- Flame Class: 94V-2/94V-0
- Color: Natural/Black
- Unit: mm

用途：可將多餘的機殼出線口遮蓋，裝配容易。

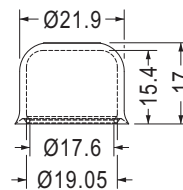
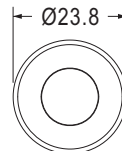

Part No.	Package
KPS-36	500

螺紋塞頭 THREADED PROTECTION PLUG

用途：可將多餘的機殼出線口遮蓋，裝配容易。



- Material: PE
- Color: Red
- Unit: mm

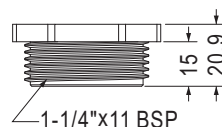
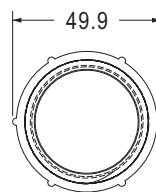

Part No.	Package
10459	250

螺絲孔塞頭 SCREW HOLE PLUG

用途：用於內六角螺絲的孔塞。



- Material: PE
- Color: Black
- Unit: mm

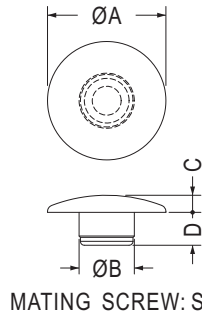

Part No.	A	B	C	D	S	Package
MHDA4.2-3	9.0	4.2	1.3	2.5	M5	2000
MHDA5.2-3.1	10.0	5.2	1.4	3.1	M6	

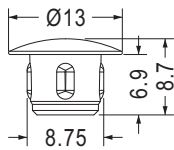
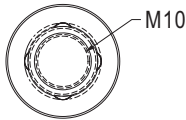

MOUNTING HOLE Ø8.5

- Material: Nylon 66 (UL)
- Flame Class: 94V-2/94V-0

Part No.	Package
MHCA8.5-6.9	1000

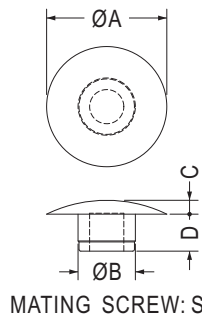

Part No.	A	B	C	D	S	Package
ACSRD-6.2	13.0	6.2	1.5	4.0	M8	1000
ACSRD-8.2	16.0	8.2	1.6	5.0	M10	
ACSRD-10.3	18.0	10.3	1.8	6.4	M12	

5



- Material: Nylon 66 (UL)
- Flame Class: 94V-2/94V-0
- Color: Black
- Unit: mm

用途：用於螺絲孔之防水及遮蔽。

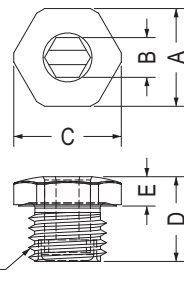

Part No.	A	B	C	D	E	Thread	Package
MOTA-12	15.0	6.1	16.5	13.0	4.5	M12x1.5P	500
MOTA-16	19.0	8.1	20.5	13.0	4.5	M16x1.5P	
MOTA-20	24.0	8.1	25.5	14.5	5.5	M20x1.5P	250

- Material: POM
- Color: Black
- Unit: mm

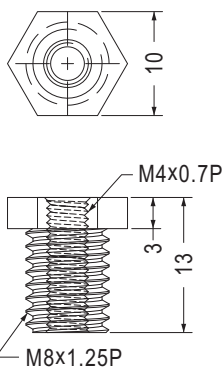

Part No.	Package
MOTB-8	500

- Material: Nylon 66 (UL)
- Flame Class: 94V-2/94V-0
- O-Ring Material: NBR
- Color: Black
- Unit: mm

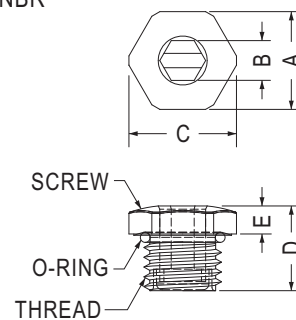

Part No.	A	B	C	D	E	Thread	Package
MOTA-12F	15.0	6.1	16.5	13.0	4.5	M12x1.5P	500
MOTA-16F	19.0	8.1	20.5	13.0	4.5	M16x1.5P	
MOTA-20F	24.0	8.1	25.5	14.5	5.5	M20x1.5P	250

螺絲孔塞頭 SCREW HOLE PLUG

用途：可將多餘的機殼出線口遮蓋，具防水功能，裝配容易。



- Material: Nylon 66 (UL)
- Flame Class: 94V-2/94V-0
- Color: Black
- Unit: mm

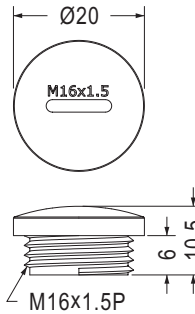

Part No.	Package
SPM-16	500

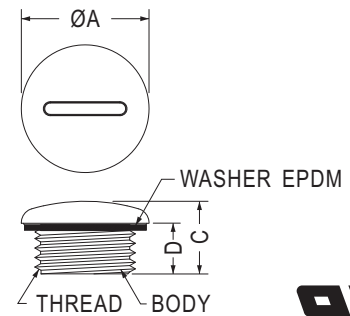
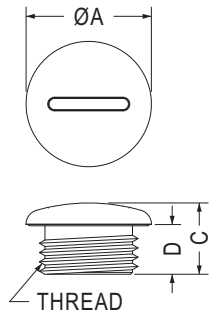

✓通過IP68防水測試

Part No.	A	C	D	Thread	Package
SPMA-10	15.0	12.5	8.5	M10x1.5	500
SPMA-12	15.0	10.0	6.0	M12x1.5	
SPMA-16	20.2	11.5	8.0	M16x1.5	
SPMA-20	24.0	12.5	7.5	M20x1.5	
SPMA-25	30.0	15.0	11.0	M25x1.5	250
SPMA-32	37.0	15.7	10.8	M32x1.5	
SPMA-32S	38.0	13.8	10.0	M32x1.5	
SPMA-40	46.0	17.5	12.0	M40x1.5	100

Part No.	A	C	D	Thread	Package
SPMB-10	15.0	12.0	8.5	M10x1.5	500
SPMB-12	15.0	10.0	6.0	M12x1.5	
SPMB-16	20.2	11.5	8.0	M16x1.5	
SPMB-20	24.0	12.5	7.5	M20x1.5	
SPMB-25	30.0	15.0	11.0	M25x1.5	200
SPMB-32	37.0	15.7	10.8	M32x1.5	
SPMB-32S	38.8	13.8	10.0	M32x1.5	
SPMB-40	46.0	17.5	12.0	M40x1.5	100

塞頭 THREADED HOLE PLUG

用途：端子的保護與防塵。



- Material: PC+ABS (UL)
- O-Ring Material: Silicon Rubber
- Flame Class: 94V-0
- Color: Black
- Unit: mm

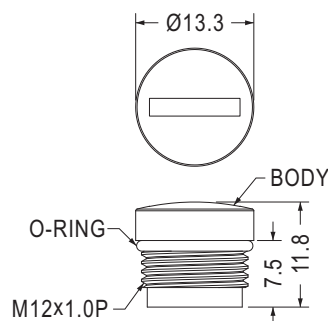

Part No.	組件(ASSY)	Package
SPMA-12LF	SPMA-12L	1000
	OR10.6-1.25I	

電源線扣 STRAIN RELIEF BUSHING

用途：用於電子電器電源出線口，固定扣牢和保護電源免於被機殼刮傷，造成短路。

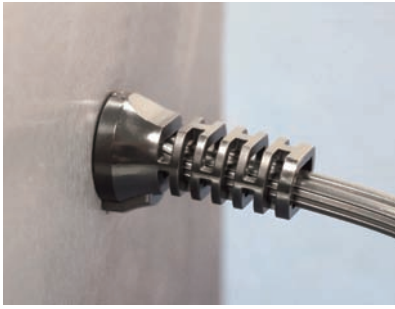

- Material: Nylon 66 (UL)
- Flame Class: 94V-2/94V-0
- Color: Black
- Unit: mm

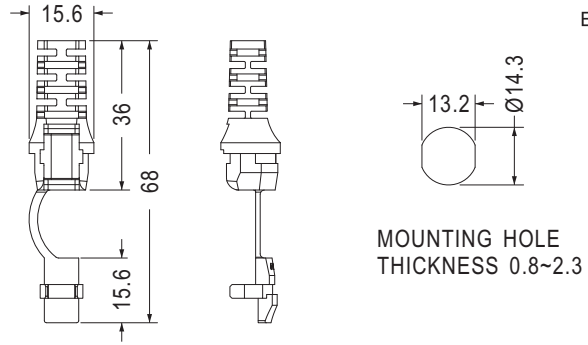

Part No.	Wires Accommodate		適用線材斷面形狀 Section Shape	Package
	UL Type Designation	Size		
SB4F-9	SPT-2	4.6x8	扁線用 Flat Type	500

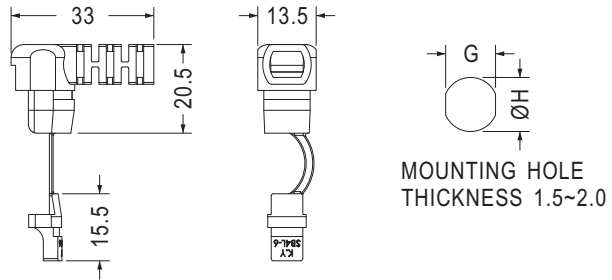

Part No.	Will Fit These Cable		Chassis Dimension		適用線材斷面形狀 Section Shape	Package
	UL Type Designation	Size	G	H		
SB4L-6	SPT-2	3.3x6.6	10.9	12.7	扁線用 Flat Type	1000
		3.6x7.2		13.2		

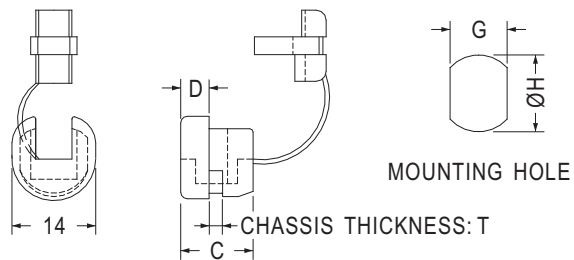

Part No.	Will Fit These Cable		Dimension		Chassis Dimension		Chassis Thickness	Package	UL
	UL/CSA Description	Size	C	D	G	H	T		
SB4F-2	SPT-2	4.1x 8.6	12.4	4.0	11.8	12.7	1.8~2.5	500	UL
SB5P-2	SJT2C#18	Ø6.8~Ø7.8	12.5	4.4	11.8	12.7	0.8~2.6		UL
SB5R-2	SJT3C#16	Ø8.2~Ø9.2	11.5	4.8	11.5	12.7	0.8~1.6		

電源線扣 STRAIN RELIEF BUSHING

用途：用於電子電器電源出線口，固定扣牢和保護電源免於被機殼刮傷，造成短路。



- Material: Nylon 66 (UL)
- Flame Class: 94V-2/94V-0
- Color: Black
- Unit: mm

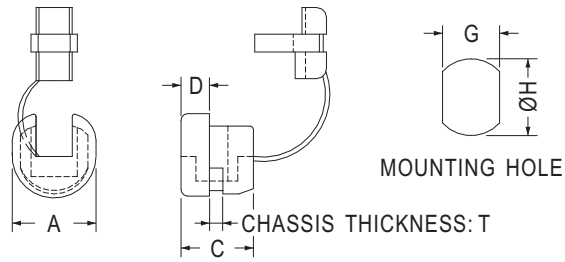

Part No.	Will Fit These Cable		Dimension			Chassis Dimension		Chassis Thickness	Package
	UL/CSA Description	Size	A	C	D	G	H	T	
SB5R-4	SJT3C#16	Ø8.2~Ø9.2	13.4	10.9	4.2	11.5	13.1	0.8~1.6	500
	SJT3C#18	Ø7.6	13.4	10.9	4.2	11.5	12.7	0.8~1.6	
SB5F-4	SPT-3	5.0x10.0	15.5	15.4	6.2	13.4	14.3	0.8~1.6	250
SB5F-6	SPT-3	5.0x10.0	15.5	15.4	6.2	13.4	14.3	1.8~3.2	
SB6R-6	SJT3C#16	Ø8.2~Ø9.2	16.6	14.6	5.6	14.0	15.9	0.8~1.6	

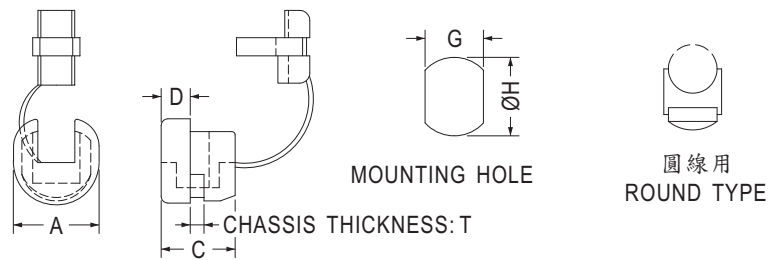

Part No.	Will Fit These Cable			Dimension			Chassis Dimension	Chassis Thickness	適用線材斷面形狀 Section Shape	Package	
	UL Type Designation	AWG Conductor	Size	A	C	D	G	H			T
SB8R-2	SJT	12/3C	Ø13.5~Ø15.2	22.6	20.4	8.4	21.7	22.0	1.8~2.5	圓線用 Round Type	100
SB9R-2		10/3C	Ø15.2~Ø16.3	27.5	25.2	10.6	25.4	28.0	1.2~7.0		
		10/3C	Ø17.5	27.5	25.2	10.6	25.4	30.2	1.2~7.0		

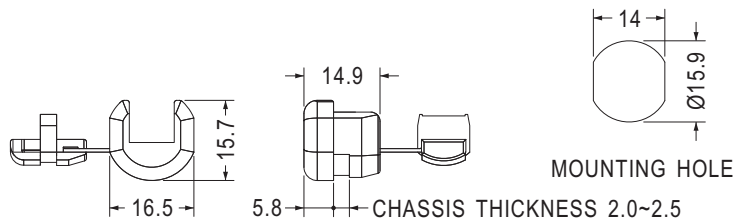

Part No.	Will Fit These Cable			Package
	UL Type Designation	AWG / Conductor	Size	
SB6P4-4	SPT-2	18/3	3.0x7.6	500
		16/3	4.1x10.4	

電源線扣 STRAIN RELIEF BUSHING

用途：用於電子電器電源出線口，固定扣牢和保護電源免於被機殼刮傷，造成短路。



- Material: Nylon 66 (UL)
- Flame Class: 94V-2/94V-0
- Color: Black
- Unit: mm

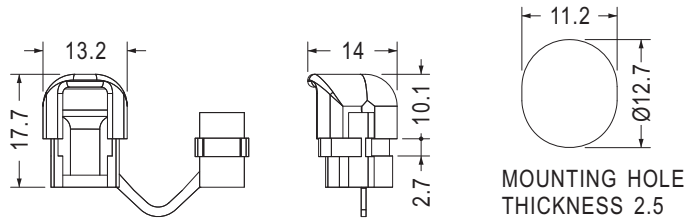

Part No.	Will Fit These Cable		Package
	UL Type Designation	Size	
SB4L-4	SPT-2	3x6.6	500
SB5L-4	SVT	6.0	

5

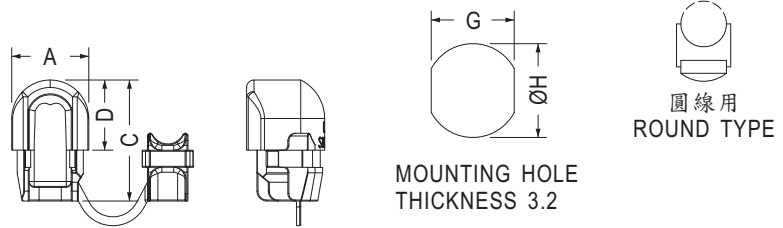

Part No.	Will Fit These Cable			Dimension			Chassis Dimension		適用線材斷面形狀 Section Shape	Package
	UL Type Designation	AWG / Conductor	Size	A	C	D	G	H		
SB6L-6	SJT	18/3C	Ø7.4~Ø8.2	15.4	24.5	14.2	14.0	15.9	圓線用 Round Type	100
SB7L-2		14/3C	Ø9.2~Ø10.5	19.5	27.8	16.3	16.5	19.0		

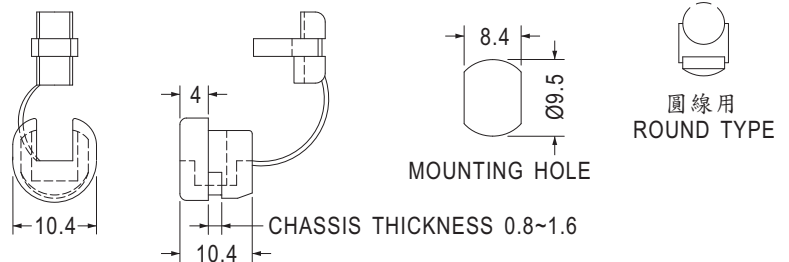

Part No.	Will Fit These Cable		適用線材斷面形狀 Section Shape	Package
	Size			
2P-1	Ø3.0~Ø4.7		圓線用 Round Type	500

電源線扣 STRAIN RELIEF BUSHING

用途：用於電子電器電源出線口，固定扣牢和保護電源免於被機殼刮傷，造成短路。



- Material: Nylon 66 (UL)
- Flame Class: 94V-2/94V-0
- Color: Black
- Unit: mm

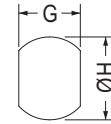
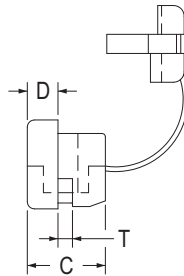
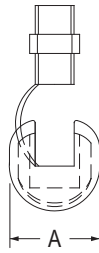

MOUNTING HOLE



圓線用
ROUND TYPE



扁線用
FLAT TYPE

Part No.	Will Fit These Cable			Dimension			Chassis Dimension		Chassis Thickness	適用線材 斷面形狀 Section Shape	Package
	UL Type Designation	AWG Conductor	Size	A	C	D	G	H	T		
2P-4	SPT-1	18/2C	3.0x5.6	10.4	10.4	4.0	8.7	9.5	1.6	扁線用 Flat Type	1000
3P-4		18/2C	3.0x5.6	11.5	10.4	4.0	9.9	11.0	1.6		
3W-1		18/2C	3.0x5.6	11.5	10.4	4.0	9.9	11.0	2.5		
4N-4	SPT-2	18/2C	3.71x7.6	13.3	10.4	4.0	11.8	12.7	1.6		
4K-4		16/2C	3.8x7.6	13.3	10.4	4.0	11.8	13.1	1.6		
		18/2C	3.71x7.6	13.3	10.5	4.0	11.8	12.7	2.5		
4K-4	16/2C	3.8x7.6	13.3	10.5	4.0	11.8	13.1	2.5			
	5N-4	SVT	18/3C	Ø6.4~Ø7.4	13.5	10.9	4.2	11.5	12.7	1.6	圓線用 Round Type
5P-4	18/3C		Ø6.4~Ø7.4	13.5	10.9	4.2	11.5	13.1	1.6		
	6N-4		18/3C	Ø6.4~Ø7.4	13.5	10.9	4.2	11.5	12.7	2.5	
18/3C			Ø6.4~Ø7.4	13.5	10.9	4.2	11.5	13.1	2.5		
6N-4	SJT	18/3C	Ø7.6	16.8	14.8	5.6	14.0	15.9	1.6		
6P-4		18/3C	Ø7.6	16.8	14.8	5.6	14.0	15.9	3.2		
6N3-4		16/3C	Ø8.2~Ø9.2	16.2	15.0	5.6	14.0	15.9	1.6		
		16/3C	Ø8.2~Ø9.2	16.2	14.8	5.7	14.0	15.9	3.2		
7N-2		14/3C	Ø9.2~Ø10.5	19.5	19.1	7.8	16.5	19.0	1.6		
		14/3C	Ø11.0	19.5	19.1	7.8	16.5	19.8	1.6		
7P-2		14/3C	Ø9.2~Ø10.5	19.5	19.4	7.8	16.5	19.0	3.2		
		14/3C	Ø11.0	19.5	19.4	7.8	16.5	19.8	3.2		

5

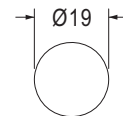
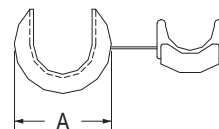

MOUNTING HOLE
THICKNESS 0.8~1.6



Part No.	Will Fit These Cable		Dimension		Package	UL
	UL/CSA Description	Size	A	C		
SB7R-7	SJT3C#10	14.0~17.0	25.0	17.0	100	UL
SB7R-7SP		12.0~15.2	25.3	17.8		

方形線扣 SQUARE STRAIN RELIEF BUSHING

用途：用於電子電器電源出線口，固定扣牢和保護電源免於被機殼刮傷，造成短路。



- Material: Nylon 66 (UL)
- Flame Class: 94V-2/94V-0
- Color: Black
- Unit: mm

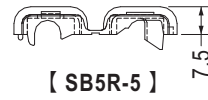
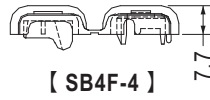
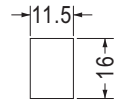
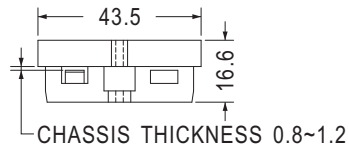
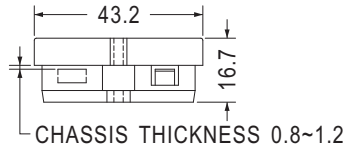

MOUNTING HOLE

【 SB4F-4 】

【 SB5R-5 】

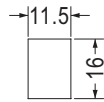
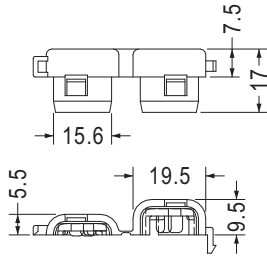

MOUNTING HOLE THICKNESS 0.8~1.2

【 SB4F-6 】

Part No.	Will Fit These Cable		Package
	UL/CSA Description	Size	
SB4F-4	SPT-1, SPT-2	3x5.6, 3.71x7.6	250
SB5R-5	SVT3C#18	Ø6.6~Ø7.2	
SB4F-6	SPT-1, SPT-2	3x5.6, 3.71x7.6	200

5

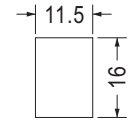
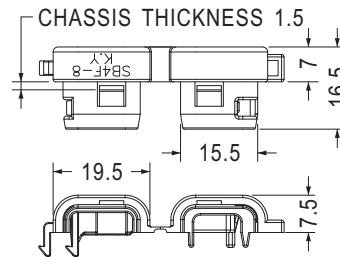

MOUNTING HOLE

Part No.	Will Fit These Cable		Package
	UL/CSA Description	Size	
SB4F-8	SPT-1, SPT-2	3x5.6, 3.71x7.6	200

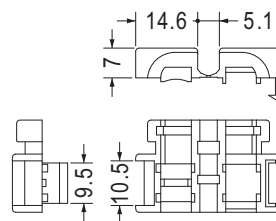

扣合前

Part No.	Package
SBU4-4	1000

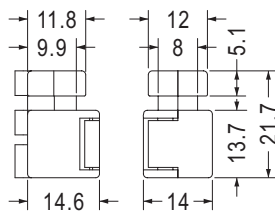

扣合後

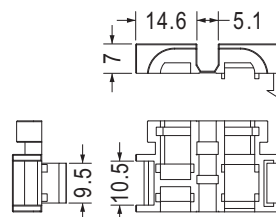

扣合前

Part No.	Package
SBU4-4-1	1000

電線線扣 STRAIN RELIEF BUSHING

用途：用於電子電器電源出線口，固定扣牢和保護電源免於被機殼刮傷，造成短路。



- Material: Nylon 66 (UL)
- Flame Class: 94V-2/94V-0
- Color: Black
- Unit: mm

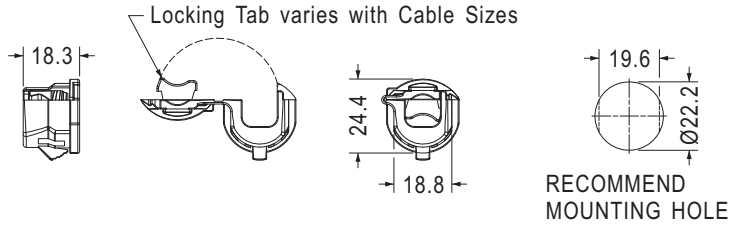

NEW

Part No.	Will Fit These Cable		Panel Dimensions		Package
	AWG/Conductors	Approximate Size	Mounting Hole Size	Thickness	
SB201	VARIOUS	7.4~9.8	22,2 w / 19,6 flats	0.8	200
				1.6	
				2.0	
				2.5	
				3.2	
				3.4	
SB301	VARIOUS	8.6~10.9	22,2 w / 19,6 flats	0.8	200
				1.6	
				2.0	
				2.5	
				3.2	
				3.4	
SB401	VARIOUS	10.7~11.4	22,2 w / 19,6 flats	0.8	200
				1.6	
				2.0	
				2.5	
				3.2	
				3.4	

電線線扣 STRAIN RELIEF BUSHING

用途：用於電子電器電源出線口，固定扣牢和保護電源免於被機殼刮傷，造成短路。

- Material: Nylon 66 (UL)
- Flame Class: 94V-2/94V-0
- Color: Black
- Unit: mm

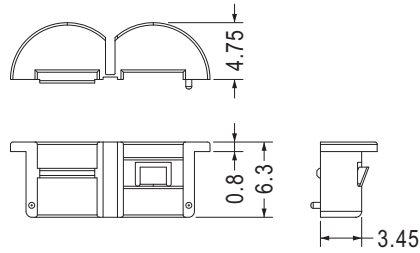

MOUNTING HOLE $\varnothing 7.0$
THICKNESS 0.6~1.1

Part No.	Package
SBU-1	2000

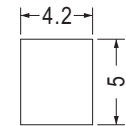
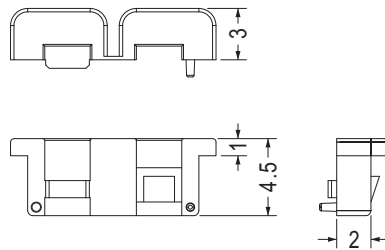

MOUNTING HOLE
THICKNESS 0.8~1.0

Part No.	Package
SBU-2	2000

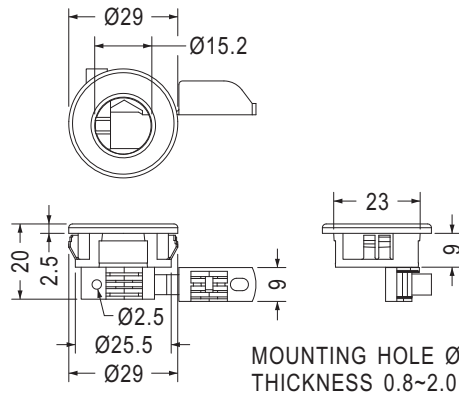

MOUNTING HOLE $\varnothing 26.0$
THICKNESS 0.8~2.0

Part No.	Package
SBB-1	200

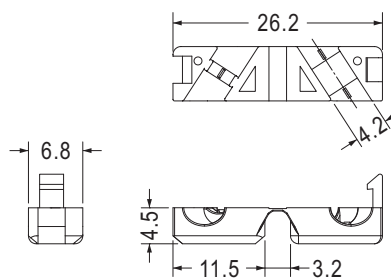

Part No.	Package
SBQC-1	100

電線固定夾 WIRE CLIP

用途：用於機殼的電線出線口，避免電源線被拉出。

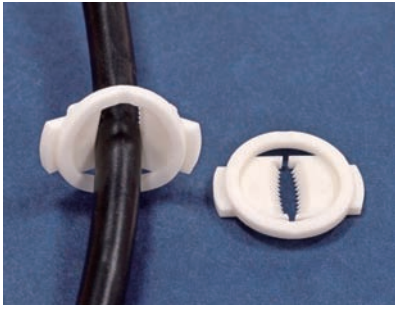

- Material: Nylon 66 (UL)
- Flame Class: 94V-2/94V-0
- Color: Natural/Black
- Unit: mm

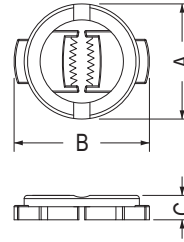

Part No.	A	B	C	Suggested Cable Diameter Range	Package
SBCR-7	17.7	20.8	3.75	Ø7.0	1000
SBCR-9	22.2	25.5	4.0	Ø9.0	

電纜固定頭 CABLE GLAND

用途：電纜防水接頭。

✓通過IP68防水測試

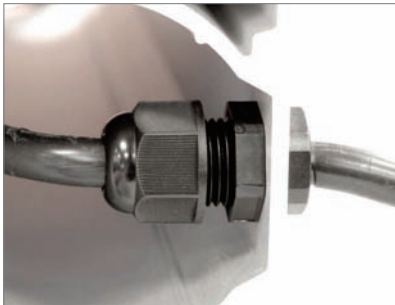

- Material: A,C,E=Nylon 66 (UL)
B,D=EPDM
- Flame Class: 94V-2/94V-0
- Color: Black
- Unit: mm

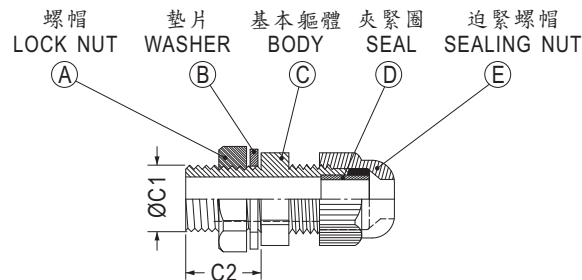

Part No.	標準螺牙 Threaded Entry Metric	適用電纜 Cable Range	螺紋外徑 Threaded O. D. C1	螺紋長度 Threaded Length C2	機板口徑 Panel Mounting Hole	板手徑 Spanner Size A & E	Package
KGB12-07	M12x1.5P	Ø6.8~Ø4.0	Ø11.8	15.0	Ø12.0~Ø12.3	18/15	100
KGB12-07-ST		Ø6.8~Ø4.0	Ø11.8	8.5	Ø12.0~Ø12.3	18/15	
KGB12-08		Ø8.5~Ø4.5	Ø11.8	8.5	Ø12.0~Ø12.3	18/15	
KGB16S-8.5-ST	M16x1.5P	Ø8.5~Ø5.0	Ø15.8	10.0	Ø16.0~Ø16.3	22/22	
KGB16-10		Ø10.4~Ø6.4	Ø15.8	15.0	Ø16.0~Ø16.3	22/22	
KGB16-10-ST		Ø10.4~Ø6.4	Ø15.8	10.0	Ø16.0~Ø16.3	22/22	
KGB20-14	M20x1.5P	Ø14.0~Ø8.5	Ø19.8	15.0	Ø20.0~Ø20.3	27/27	50
KGB20-14-ST		Ø14.0~Ø8.5	Ø19.8	10.0	Ø20.0~Ø20.3	27/27	
KGB25-16	M25x1.5P	Ø16.0~Ø12.0	Ø24.9	15.0	Ø25.0~Ø25.4	33/33	
KGB25-16-ST		Ø16.0~Ø12.0	Ø24.9	10.0	Ø25.0~Ø25.4	33/33	
KGB32-25	M32x1.5P	Ø25.0~Ø18.0	Ø32.0	15.5	Ø32.0~Ø32.4	41/42	200
KGB32-25-ST		Ø25.0~Ø18.0	Ø32.0	10.5	Ø32.0~Ø32.4	41/42	
KPGB7-5	PG7	Ø5.5~Ø3.0	Ø12.3	8.0	Ø12.5~Ø12.8	17/15	100
KPGB7-5-1		Ø5.5~Ø3.0	Ø12.3	8.0	Ø12.5~Ø12.8	17/15	
KPGB9-9	PG9	Ø8.0~Ø4.5	Ø15.1	8.5	Ø15.2~Ø15.5	22/19	100
KPGB11-7	PG11	Ø7.0~Ø4.0	Ø18.4	10.0	Ø18.6~Ø18.9	24/22	
KPGB13.5-8	PG13.5	Ø9.0~Ø5.0	Ø20.2	10.0	Ø20.4~Ø20.7	27/24	

透氣壓力平衡固定頭 PRESSURE BALANCE GLAND



- Material: A=Nylon 66 (UL)
B=EPDM
C,D=PC (UL)
- Flame Class: 94V-2/94V-0
- Color: Natural/Black
- Unit: mm

用途：用於機器透氣和防水。

✓通過IP68防水測試

✓典型透氣量2500ml/分鐘 (壓差7kpa)



防水透氣布
測試影片

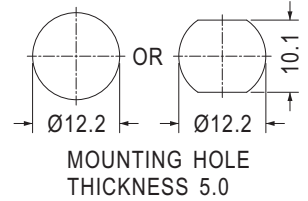
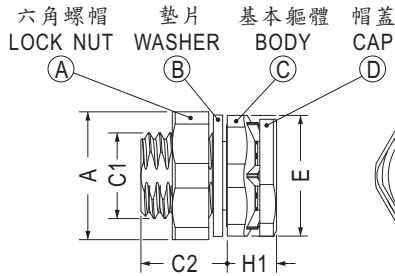

Part No.	標準螺牙 Threaded Entry Metric C1	螺紋長度 Threaded Length C2	高度 Height H1	扳手徑 Spanner Size A & E	Package
MOR12-12	M12x1.5P	12.0	7.0	18/17	500

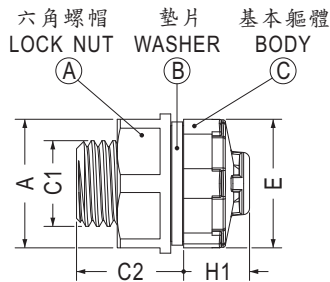

Part No.	標準螺牙 Threaded Entry Metric C1	螺紋長度 Threaded Length C2	高度 Height H1	扳手徑 Spanner Size A & E	Package
MOR8-10	M8x1.0P	10.0	6.15	12/12	500

透氣壓力平衡固定扣 PRESSURE BALANCE FASTENER



- Material: A,B=PC (UL)
C=Silicon Rubber
- Flame Class: 94V-0
- Color: Black
- Unit: mm

用途：用於機器透氣和防水。

✓通過IP68防水測試

✓典型透氣量2500ml/分鐘 (壓差7kpa)

裝配孔尺寸，僅供參考
Mounting holes are for reference only.



防水透氣布
測試影片

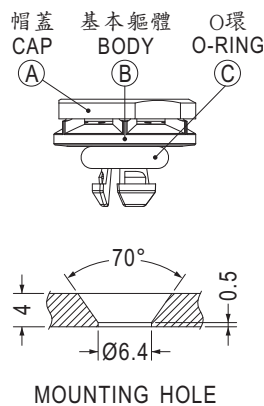
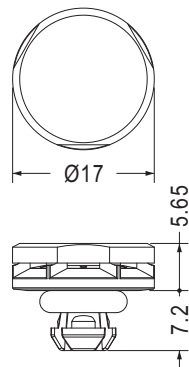

Part No.	Package
MOR-6.4	500

方型護線環 SQUARE SNAP BUSHING

用途：用於鐵板間電線出入刮傷之保護，不易脫落，使用方便，不佔空間之優點。



- Material: Nylon 66 (UL)
- Flame Class: 94V-2/94V-0
- Color: Natural/Black
- Unit: mm

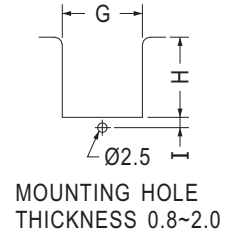
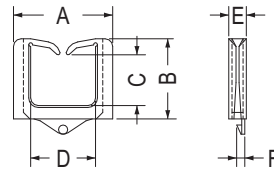

裝配孔尺寸，僅供參考
Mounting holes are for reference only.

Part No.	A	B	C	D	E	F	G	H	I	Package
SQE-1	19.8	12.1	7.3	11.5	4.5	2.3	14.0	12.3	2.8	1000
SQE-2	26.0	21.0	14.0	17.0	4.6	2.3	21.0	21.0	2.7	500
SQE-2-1	26.0	21.0	14.0	17.0	4.6	1.87	21.0	21.0	2.7	
SQE-3	33.2	28.8	22.4	22.7	4.5	2.3	27.0	29.0	2.8	

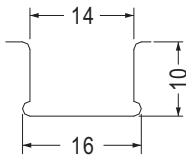
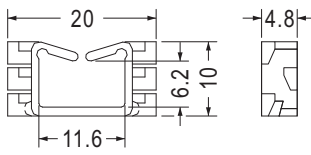

MOUNTING HOLE THICKNESS: T

Part No.	T	Package
SQF-1	0.8~1.2	500
SQF-7	1.9~2.0	

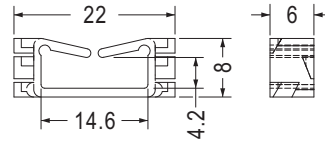

MOUNTING HOLE THICKNESS 1.2~2.8

Part No.	Package
SQF-2	500

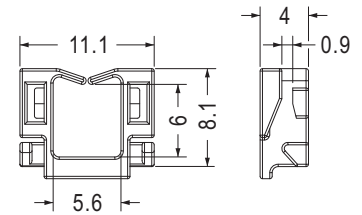

MOUNTING HOLE THICKNESS 1.2

Part No.	Package
SQF-4	500



裝配孔尺寸，僅供參考
Mounting holes are for reference only.

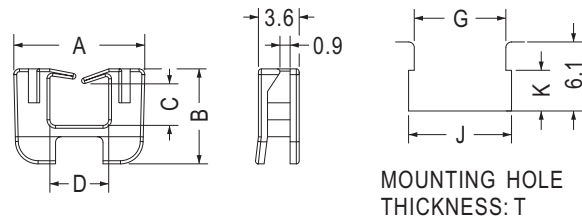

MOUNTING HOLE THICKNESS: T

Part No.	A	B	C	D	G	J	K	T	Package
SQF-5	11.6	8.4	3.7	5.2	8.1	9.1	3.6	0.8~1.8	500
SQF-6	16.9	9.1	3.4	10.2	12.8	13.8	3.4	0.9~2.0	
SQF-8	16.9	9.0	3.2	10.2	13.0	14.0	3.4	0.9~2.0	



裝配孔尺寸，僅供參考
Mounting holes are for reference only.

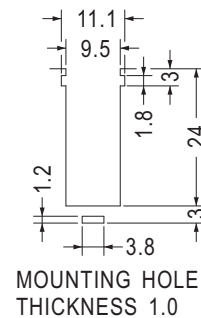
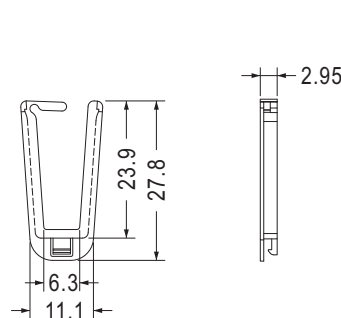

MOUNTING HOLE THICKNESS 1.0

Part No.	Package
SQE-5	500

方型護線環 SQUARE SNAP BUSHING

用途：用於鐵板間電線出入刮傷之保護，不易脫落，使用方便，不佔空間之優點。

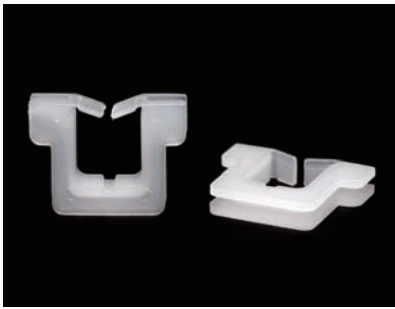

- Material: Nylon 66 (UL)
- Flame Class: 94V-2/94V-0
- Color: Natural/Black
- Unit: mm

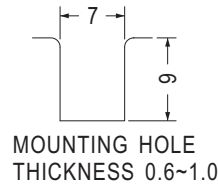
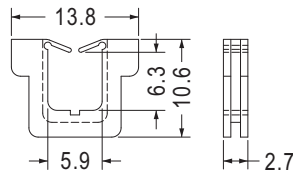

Part No.	Package
SQK-1	1000

裝配孔尺寸，僅供參考
Mounting holes are for reference only.

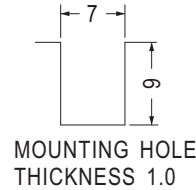
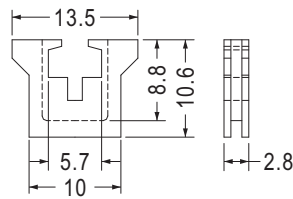

Part No.	Package
SQD-1	1000



裝配孔尺寸，僅供參考
Mounting holes are for reference only.

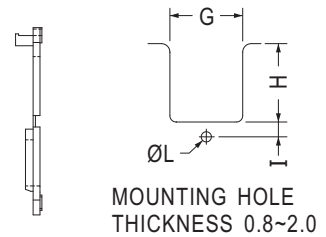
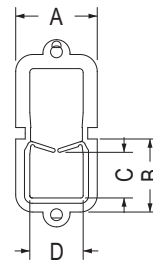

Part No.	A	B	C	D	G	H	I	L	Package
SQB-1	18.4	14.5	8.9	11.0	14.0	12.3	2.7	2.7	500
SQB-2	21.5	18.8	11.9	13.9	17.2	18.5	3.5	3.0	

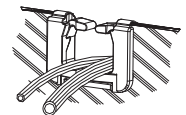
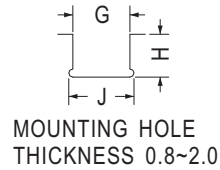
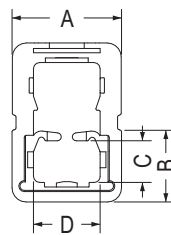
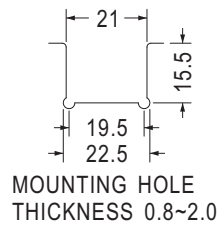
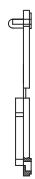
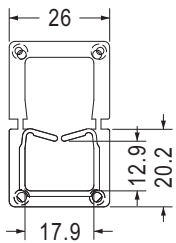

UNIT FOLDED VIEW

Part No.	Package
SQB-3	500

Part No.	A	B	C	D	G	H	J	Package
SQB-4	22.0	14.2	9.0	14.0	17.0	13.5	19.0	500
SQB-5	17.9	11.8	6.8	10.9	14.0	10.5	16.0	1000



裝配孔尺寸，僅供參考
Mounting holes are for reference only.

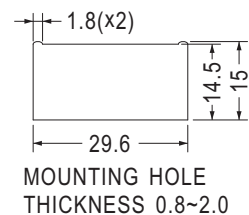
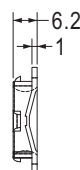
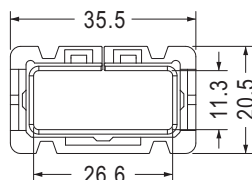

Part No.	Package
SQL-1	500

方型護線環 SQUARE SNAP BUSHING

用途：用於鐵板間電線出入刮傷之保護，不易脫落，使用方便，不佔空間之優點。



- Material: Nylon 66 (UL)
- Flame Class: 94V-2/94V-0
- Color: Natural/Black
- Unit: mm

裝配孔尺寸，僅供參考
Mounting holes are for reference only.

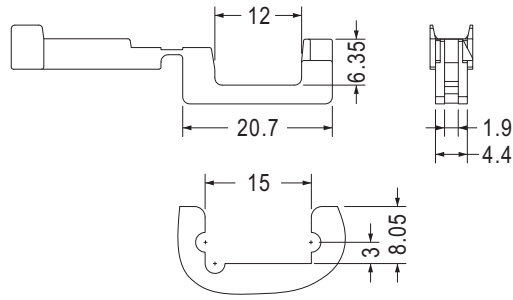

MOUNTING HOLE THICKNESS 1.5

Part No.	Package
SQJ-3	1000

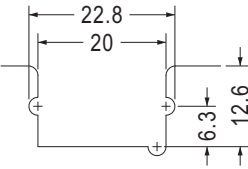
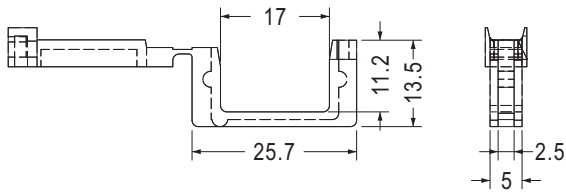

MOUNTING HOLE THICKNESS 2.1

Part No.	Package
SQJ-1	1000

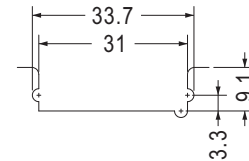
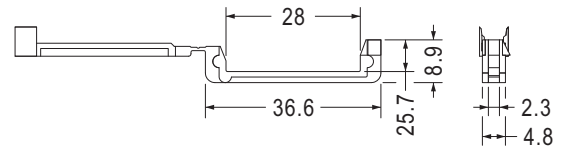

MOUNTING HOLE THICKNESS 2.0

Part No.	Package
SQJ-2	500



裝配孔尺寸，僅供參考
Mounting holes are for reference only.

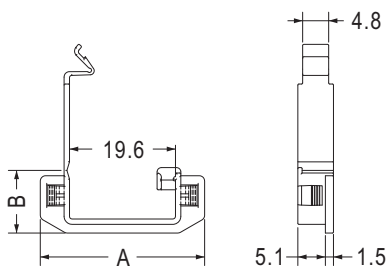

PANEL MOUNTING DETAILS

THROUGH HOLE INSTALLATION

EDGE INSTALLATION

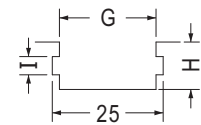
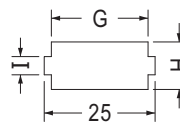

THICKNESS 0.8~1.6

【SQJA-1】

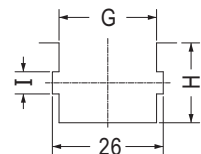
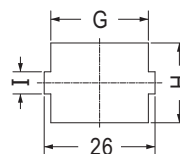

THICKNESS 2.0

【SQJA-2】

Part No.	A	B	G	H	I	Package
SQJA-1	30.4	11.6	21.8	10.7	4.1	500
SQJA-2	31.0	18.6	22.0	18.0	5.0	

方型護線環 SQUARE SNAP BUSHING

用途：用於鐵板間電線出入刮傷之保護，不易脫落，使用方便，不佔空間之優點。



- Material: Nylon 66 (UL)
- Flame Class: 94V-2/94V-0
- Color: Natural/Black
- Unit: mm

裝配孔尺寸，僅供參考
Mounting holes are for reference only.

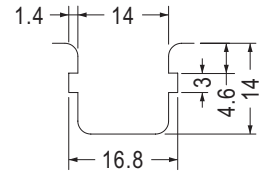
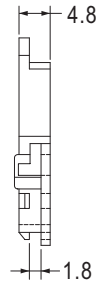
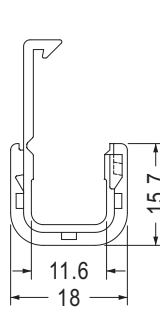

MOUNTING HOLE THICKNESS 0.8~1.8

Part No.	Package
SQA-1	1000

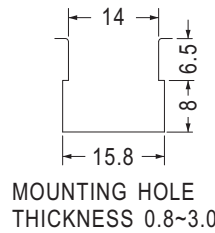
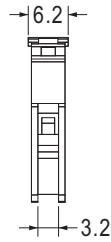
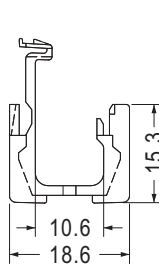

MOUNTING HOLE THICKNESS 0.8~3.0

Part No.	Package
SQA-1	1000

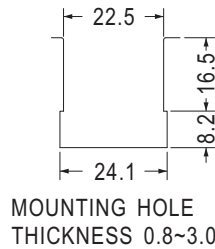
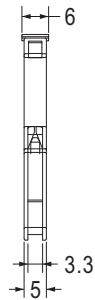
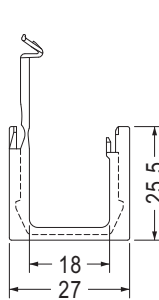

MOUNTING HOLE THICKNESS 0.8~3.0

Part No.	Package
SQA-2	500

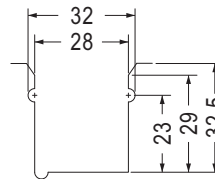
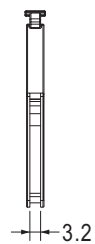
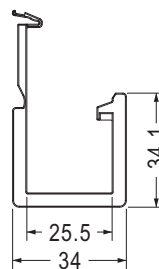

MOUNTING HOLE THICKNESS 3.0

Part No.	Package
SQA-3	1000

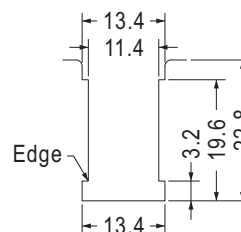
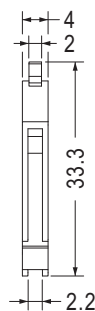
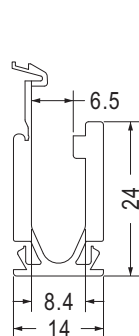

MOUNTING HOLE THICKNESS 2.0

Part No.	Package
SQR-1	1000

方型護線環 SQUARE SNAP BUSHING

用途：用於鐵板間電線出入刮傷之保護，不易脫落，使用方便，不佔空間之優點。



- Material: Nylon 66 (UL)
- Flame Class: 94V-2/94V-0
- Color: Natural/Black
- Unit: mm

裝配孔尺寸，僅供參考
Mounting holes are for reference only.

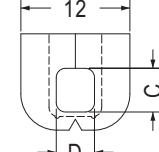
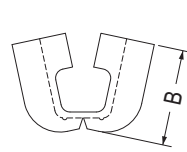
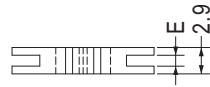

CLOSE PART

MOUNTING HOLE THICKNESS 0.8~1.0

Part No.	B	C	D	E	Package
SQG-1	10.6	4.8	4.2	1.2	1000
SQG-3	10.9	4.5	2.3	1.1	
SQG-4	10.7	4.6	4.6	1.1	
SQG-6	10.9	6.8	2.3	1.2	

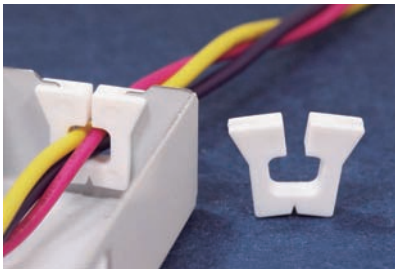

裝配孔尺寸，僅供參考
Mounting holes are for reference only.

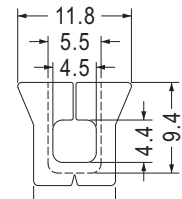
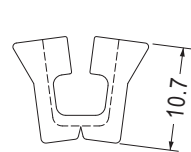

CLOSE PART

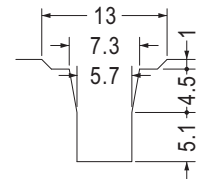

MOUNTING HOLE THICKNESS 0.5~0.8

Part No.	Package
SQG-15	1000



裝配孔尺寸，僅供參考
Mounting holes are for reference only.

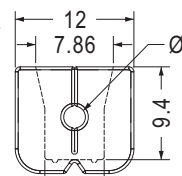
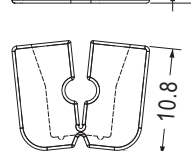

CLOSE PART

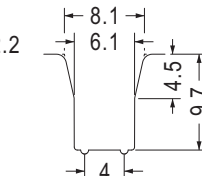

MOUNTING HOLE THICKNESS 0.6

Part No.	Package
SQG-9	1000



裝配孔尺寸，僅供參考
Mounting holes are for reference only.

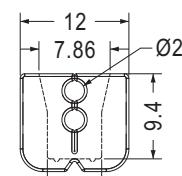
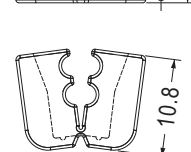

CLOSE PART

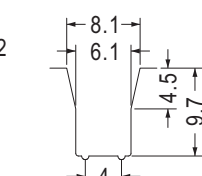

MOUNTING HOLE THICKNESS 0.6

Part No.	Package
SQG-10	1000

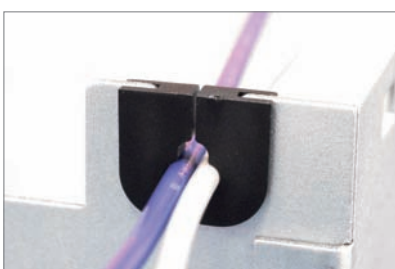

裝配孔尺寸，僅供參考
Mounting holes are for reference only.

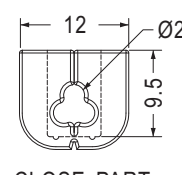
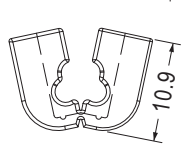
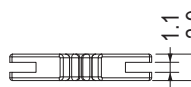

CLOSE PART

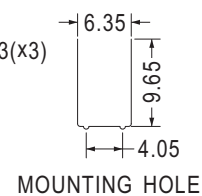

MOUNTING HOLE THICKNESS 0.8~1.0

Part No.	Package
SQG-8	1000

方型護線環 SQUARE SNAP BUSHING

用途：用於鐵板間電線出入刮傷之保護，不易脫落，使用方便，不佔空間之優點。

- Material: Nylon 66 (UL)
- Flame Class: 94V-2/94V-0
- Color: Natural/Black
- Unit: mm

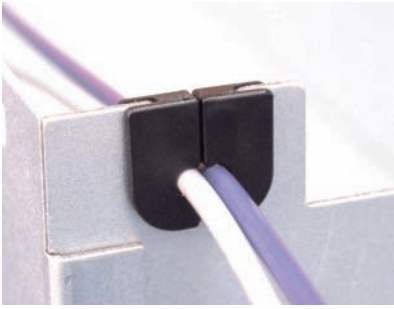

裝配孔尺寸，僅供參考
Mounting holes are for reference only.

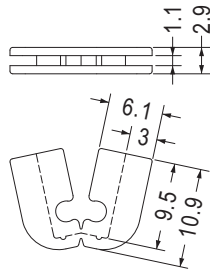

CLOSE PART

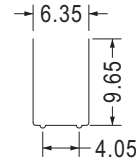

MOUNTING HOLE THICKNESS 0.8~1.0

Part No.	Package
SQG-12	1000

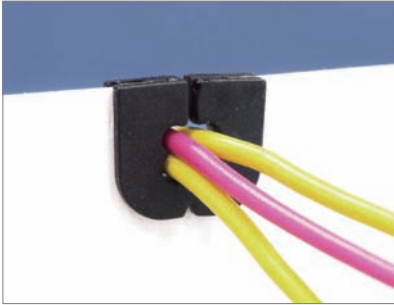

裝配孔尺寸，僅供參考
Mounting holes are for reference only.

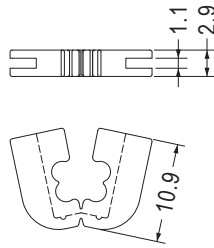

CLOSE PART

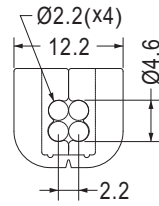

MOUNTING HOLE THICKNESS 0.8~1.0

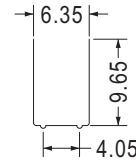

Part No.	Package
SQG-14	1000



裝配孔尺寸，僅供參考
Mounting holes are for reference only.

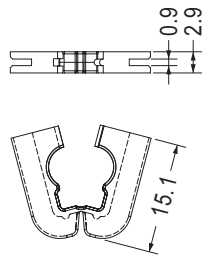

CLOSE PART

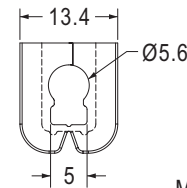

MOUNTING HOLE THICKNESS 0.8~1.0

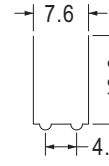

Part No.	Package
SQG-5	1000



裝配孔尺寸，僅供參考
Mounting holes are for reference only.

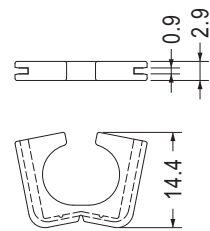

CLOSE PART

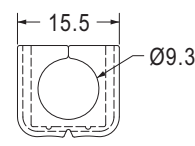

MOUNTING HOLE THICKNESS 0.8

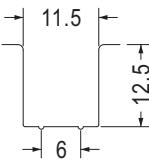

Part No.	Package
SQG-13	1000

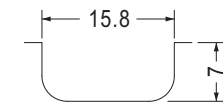
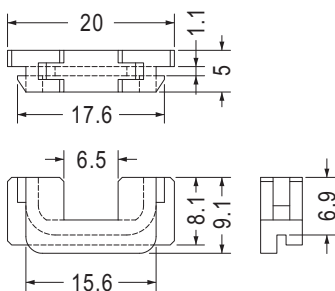

MOUNTING HOLE THICKNESS 1.0
(RECOMMEND FOR REFERENCE ONLY)

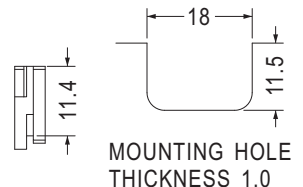
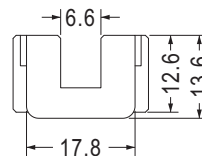
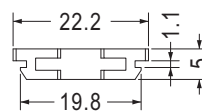

MOUNTING HOLE THICKNESS 1.0

Part No.	Package
SQN-1	1000

Part No.	Package
SQN-2	1000

護線環 SNAP BUSHING

用途：用於電線、電纜之固定及保護。



- Material: PC+ABS (UL)
- Flame Class: 94V-2/94V-0
- Color: Black
- Unit: mm

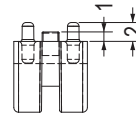
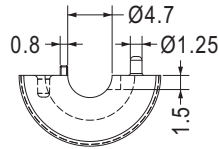
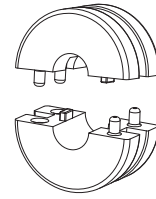
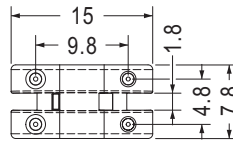

Part No.	Package
SBUT-1	1000

U型護線環 U TYPE SNAP BUSHING

用途：用於鐵板間電線出入刮傷之保護，不易脫落，使用方便，不佔空間之優點。

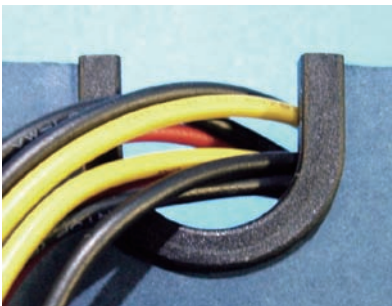

- Material: Nylon 66 (UL)
- Flame Class: 94V-2/94V-0
- Color: Natural/Black
- Unit: mm

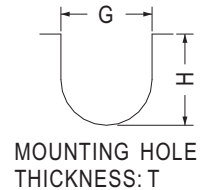
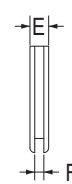
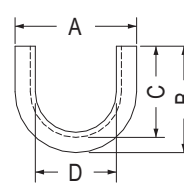

裝配孔尺寸，僅供參考
Mounting holes are for reference only.

Part No.	A	B	C	D	E	F	G	H	T	Package
SQH-1	24.0	21.0	18.0	16.0	3.7	1.8	18.0	18.0	1.7	1000
SQH-2	24.3	27.0	24.5	17.5	3.9	1.9	19.3	24.5	1.7~1.8	
SQH-2L	24.3	27.0	24.5	17.5	4.1	2.1	19.3	24.5	2.0	500
SQH-6	28.3	29.5	26.5	20.7	4.0	2.0	22.0	26.7	1.6~1.8	1000
★SQH-7	28.0	35.9	33.0	19.0	4.0	2.0	22.2	33.0	1.6~1.8	

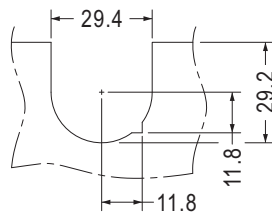
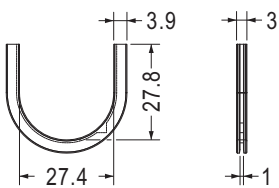

MOUNTING HOLE THICKNESS 0.8

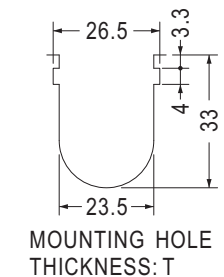
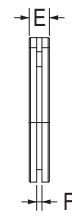
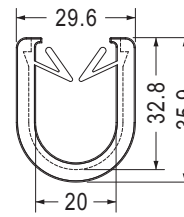

MOUNTING HOLE THICKNESS: T

Part No.	Package
★SQH-9	1000

Part No.	E	F	T	Package
SQM-1	5.0	1.3	0.8~1.2	500
SQM-1L	5.8	2.1	2.0	

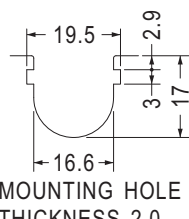
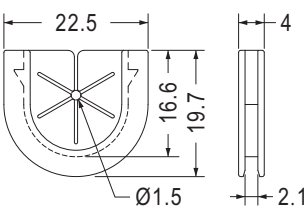

MOUNTING HOLE THICKNESS 2.0

- Material: PE
- Color: Natural
- Unit: mm

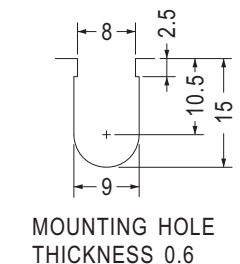
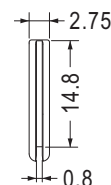
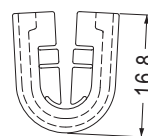

MOUNTING HOLE THICKNESS 0.6

Part No.	Package
SQHB-14	1000

Part No.	Package
SQHB-10	1000

U型護線環 U TYPE SNAP BUSHING

用途：用於鐵板間電線出入刮傷之保護，不易脫落，使用方便，不佔空間之優點。

- Material: Nylon 66 (UL)
- Flame Class: 94V-2/94V-0
- Color: Natural/Black
- Unit: mm

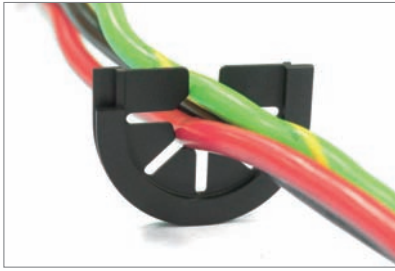

裝配孔尺寸，僅供參考
Mounting holes are for reference only.

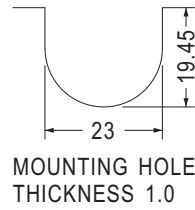
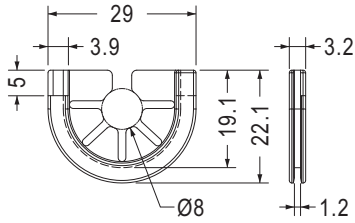

Part No.	Package
SQHB-1	1000

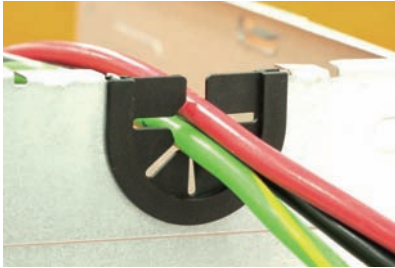

裝配孔尺寸，僅供參考
Mounting holes are for reference only.

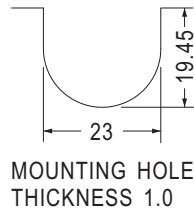
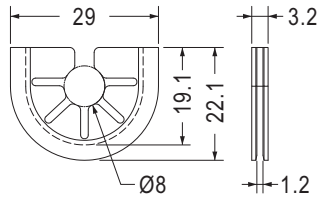

Part No.	Package
SQHB-7	1000



裝配孔尺寸，僅供參考
Mounting holes are for reference only.

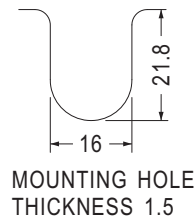
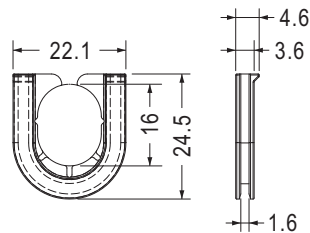

Part No.	Package
SQHB-5	1000



裝配孔尺寸，僅供參考
Mounting holes are for reference only.

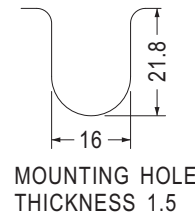
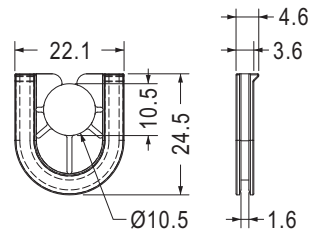

Part No.	Package
SQHB-6	1000



裝配孔尺寸，僅供參考
Mounting holes are for reference only.

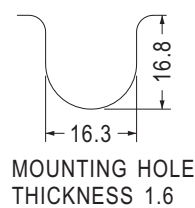
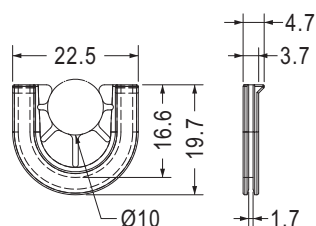

Part No.	Package
SQHB-3	1000

U型護線環 U TYPE SNAP BUSHING



裝配孔尺寸，僅供參考
Mounting holes are for reference only.

- Material: Nylon 66 (UL)
- Flame Class: 94V-2/94V-0
- Color: Natural/Black
- Unit: mm

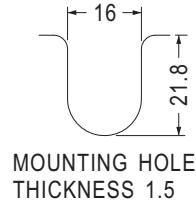
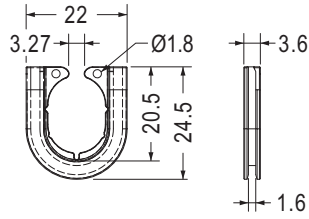

Part No.	Package
SQHB-8	1000

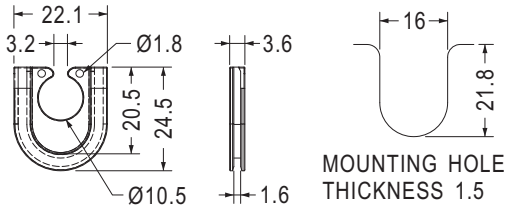

MOUNTING HOLE THICKNESS 1.5

Part No.	Package
SQHB-9	1000

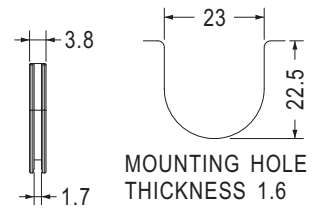
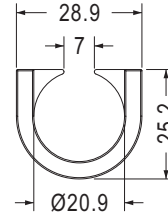

Part No.	Package
SQHB-13	1000

方型護線環 SQUARE SNAP BUSHING



裝配孔尺寸，僅供參考
Mounting holes are for reference only.

- Material: Nylon 66 (UL)
- Flame Class: 94V-2/94V-0
- Color: Natural/Black
- Unit: mm

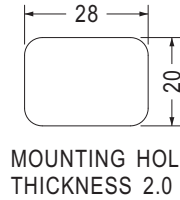
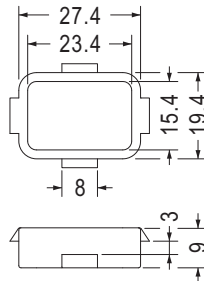

Part No.	Package
SQS-1	500

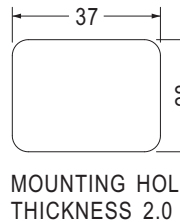
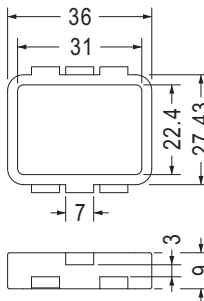
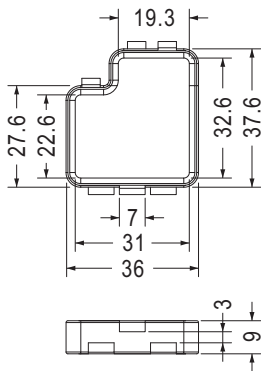

Part No.	Package
SQS-2	500

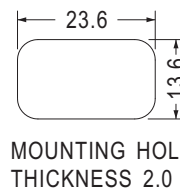
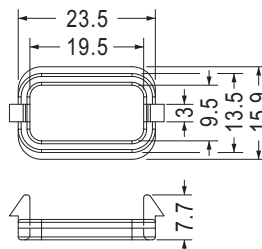
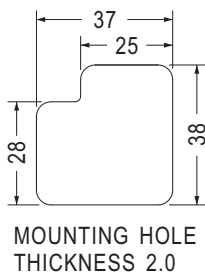

Part No.	Package
SQS-3	1000

Part No.	Package
SQS-4	500

用途：用於鐵板間電線出入刮傷之保護，不易脫落，使用方便，不佔空間之優點。

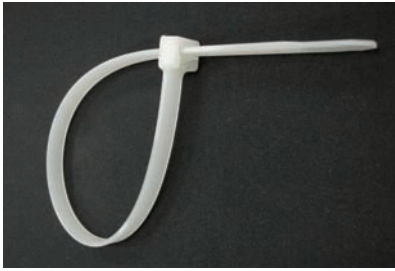

- Material: Nylon 66 (UL)
- Flame Class: 94V-2
- Color: Natural/Black
- Unit: mm
- UL Recognized

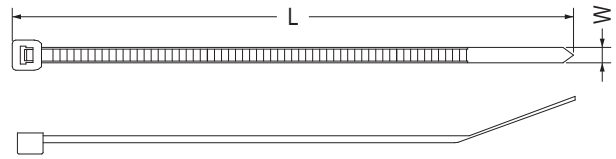

【 Self-Locking Tie 】

New Part No.	Part No.	Approx. Length	Approx. Width	Max. Bundle	Min. Loop	Package	
		mm(in)	mm(in)				
		L	W	mm(in)	Tensile Strength		
					kgs.(lbs.)		
GT-80M	YJ-80	80(3.15")	2.5(0.10")	17(0.67")	8(18)	1000	
GT-90M	YJ-90	90(3.54")	2.5(0.10")	21(0.83")	8(18)		
GT-100M	YJ-98	98(3.86")	2.5(0.10")	22(0.87")	8(18)		
GT-100M	YJ-100	100(4.00")	2.5(0.10")	23(0.91")	8(18)		
GT-120M	YJ-120	120(4.72")	2.5(0.10")	30(1.18")	8(18)		
GT-140M	YJ-142S	142(5.59")	2.5(0.10")	36(1.42")	8(18)		
GT-160M	YJ-160	160(6.30")	2.5(0.10")	42(1.66")	8(18)		
-----	YJ-181	181(7.13")	2.5(0.10")	49(1.92")	8(18)		
GT-200M	YJ-203S	203(8.00")	2.5(0.10")	56(2.21")	8(18)		
-----	YJ-102	102(4.00")	3.6(0.14")	22(0.87")	18(40)		500
GT-120I	YJ-122	122(4.80")	3.6(0.14")	29(1.14")	18(40)	1000	
GT-140I	YJ-142	142(5.59")	3.6(0.14")	34(1.34")	18(40)	500	
-----	YJ-163	163(6.41")	3.6(0.14")	40(1.57")	18(40)	500	
GT-180I	YJ-185	185(7.28")	3.6(0.14")	47(1.85")	18(40)	1000	
GT-200I	YJ-203	203(8.00")	3.6(0.14")	55(2.17")	18(40)	500	
GT-250I	YJ-232	232(9.13")	3.6(0.14")	63(2.48")	18(40)	500	
GT-250I	YJ-249	249(9.13")	3.6(0.14")	63(2.48")	18(40)		
-----	YJ-263	263(10.35")	3.6(0.14")	73(2.87")	18(40)		
GT-300I	YJ-295	295(11.61")	3.6(0.14")	83(3.27")	18(40)	1000	
-----	YJ-331	331(13.00")	3.6(0.14")	96(3.78")	18(40)	500	
GT-370I	YJ-370	370(14.57")	3.6(0.14")	108(4.25")	18(40)		
GT-120ST	YJ-115	115(4.53")	4.8(0.19")	29(1.15")	23(50)		
GT-150ST	YJ-140	140(5.50")	4.8(0.19")	34(1.34")	23(50)		
GT-160ST	YJ-162	162(6.38")	4.8(0.19")	42(1.66")	23(50)		
GT-190ST	YJ-188	188(7.40")	4.8(0.19")	49(1.93")	23(50)		
GT-200ST	YJ-201	201(8.00")	4.8(0.19")	53(2.08")	23(50)		
GT-216ST	YJ-216	216(8.50")	4.8(0.19")	58(2.28")	23(50)		
GT-250ST	YJ-242	242(9.53")	4.8(0.19")	66(2.60")	23(50)		
GT-266ST	YJ-266	266(10.47")	4.8(0.19")	72(2.84")	23(50)		
GT-300ST	YJ-292	292(11.50")	4.8(0.19")	82(3.23")	23(50)		
-----	YJ-330	330(13.00")	4.8(0.19")	93(3.66")	23(50)		
GT-370ST	YJ-368	368(14.49")	4.8(0.19")	106(4.17")	23(50)		
GT-430ST	YJ-410	410(16.14")	4.8(0.19")	122(4.80")	23(50)		
GT-450ST	YJ-450	450(17.72")	4.8(0.19")	135(5.31")	23(50)	1000	
-----	YJ-148	148(5.83")	7.6(0.30")	36(1.42")	54(120)	100	
GT-200HD	YJ-182	182(7.17")	7.6(0.30")	46(1.81")	54(120)		
-----	YJ-215	215(8.46")	7.6(0.30")	59(2.32")	54(120)		
GT-250HD	YJ-254	254(10.00")	7.6(0.30")	71(2.80")	54(120)		
GT-300HD	YJ-293	293(11.54")	7.6(0.30")	84(3.30")	54(120)		
-----	YJ-332	332(13.00")	7.6(0.30")	95(3.74")	54(120)		
GT-370HD	YJ-368L	368(14.49")	7.6(0.30")	109(4.29")	54(120)		
-----	YJ-420	420(16.54")	7.6(0.30")	124(4.88")	54(120)		
-----	YJ-470	470(18.50")	7.6(0.30")	140(5.51")	54(120)		
-----	YJ-520	520(20.47")	7.6(0.30")	156(6.14")	54(120)		
-----	YJ-178	178(7.00")	9.0(0.35")	45(1.76")	80(175)	1000	
-----	YJ-229	229(9.00")	9.0(0.35")	61(2.40")	80(175)		
-----	YJ-280	280(11.00")	9.0(0.35")	77(3.03")	80(175)		
-----	YJ-329	329(13.00")	9.0(0.35")	93(3.66")	80(175)		
-----	YJ-382	382(15.00")	9.0(0.35")	110(4.33")	80(175)		
-----	YJ-458	458(18.00")	9.0(0.35")	135(5.32")	80(175)		
GT-530HD	YJ-530	530(20.87")	9.0(0.35")	155(6.10")	80(175)		100
-----	YJ-655	655(25.79")	9.0(0.35")	194(7.64")	80(175)		
GT-780HD	YJ-780	780(30.71")	9.0(0.35")	234(9.21")	80(175)		
GT-830HD	YJ-815	815(32.00")	9.0(0.35")	247(9.72")	80(175)		

電線束線帶 CABLE TIE

用途：捆紮電線、物品，此系列為可重複性使用。

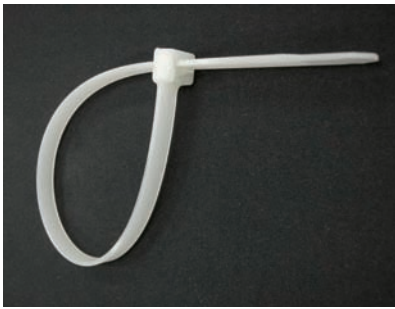

- Material: Nylon 66 (UL)
- Flame Class: 94V-2
- Color: Natural/Black
- Unit: mm

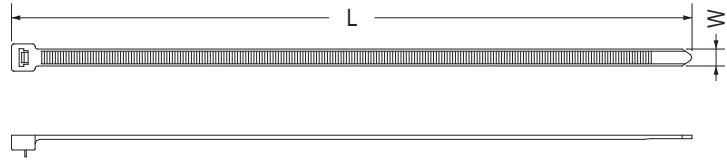

【 Releasable Tie 】

Part No.	Approx. Length mm(in)	Approx. Width mm(in)	Max. Bundle mm(in)	Min. Loop Tensile Strength kgs.(lbs.)	Package
	L	W			
YJ-R300	300(11.81")	7.6(0.30")	86(3.38")	23(50)	100
YJ-R350	350(13.87")		102(4.02")		
YJ-R400	400(15.75")		118(4.65")		
YJ-R655	655(25.79")	9.0(0.35")	194(7.64")	80(175)	
YJ-R780	780(30.71")		234(9.21")		
YJ-R815	815(32.00")		247(9.72")		

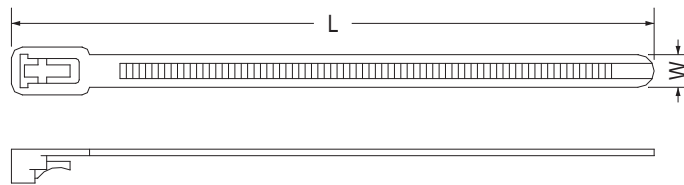

【 Releasable Tie 】

Part No.	Approx. Length mm(in)	Approx. Width mm(in)	Max. Bundle mm(in)	Min. Loop Tensile Strength kgs.(lbs.)	Package
	L	W			
YJ-R150	150(5.90")	7.5(0.295")	39(1.54")	23(50)	100
YJ-R200	200(7.87")		56(2.21")		
YJ-R250	250(9.84")		72(2.83")		

電線束線帶 CABLE TIE

用途：捆紮電線、物品，此系列為可重複性使用。



- Material: Nylon 66 (UL)
- Flame Class: 94V-2
- Color: Natural/Black
- Unit: mm

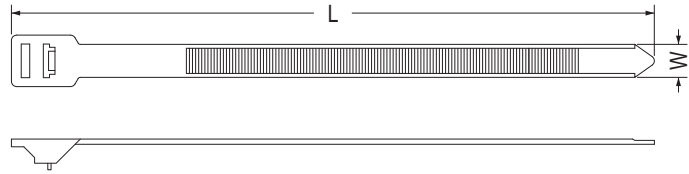

【 Releasable Tie 】

Part No.	Approx. Length mm(in)	Approx. Width mm(in)	Max. Bundle mm(in)	Min. Loop Tensile Strength kgs.(lbs.)	Package
	L	W			
YJ-R228	228(9.00")	12.7(0.50")	54(2.12")	114(250)	100
YJ-R256	256(10.00")		62(2.44")		
YJ-R279	279(11.00")		70(2.75")		
YJ-R305	305(12.00")		78(3.07")		
YJ-R328	328(13.00")		86(3.38")		
YJ-R355	355(14.00")		94(3.70")		
YJ-R380	380(15.00")		102(4.00")		
YJ-R405	405(16.00")		110(4.33")		
YJ-R430	430(17.00")		118(4.64")		
YJ-R455	455(18.00")		127(5.00")		
YJ-R485	485(19.00")		135(5.31")		
YJ-R510	510(20.00")		143(5.62")		
YJ-R534	534(21.00")		151(5.94")		
YJ-R560	560(22.00")		159(6.25")		
YJ-R585	585(23.00")		167(6.57")		
YJ-R610	610(24.00")		175(6.88")		
YJ-R635	635(25.00")		183(7.20")		
YJ-R660	660(26.00")		191(7.51")		
YJ-R685	685(27.00")		199(7.83")		
YJ-R710	710(28.00")		207(8.14")		
YJ-R735	735(29.00")	215(8.46")			
YJ-R760	760(30.00")	224(8.81")			
YJ-R790	790(31.00")	232(9.13")			
YJ-R813	813(32.00")	243(9.57")			
YJ-R915	915(36.00")	274(10.79")			
YJ-R1042	1042(41.00")	314(12.36")			



- Material: Nylon 66 (UL)
- Flame Class: 94V-2
- Color: Natural/Black
- Unit: mm

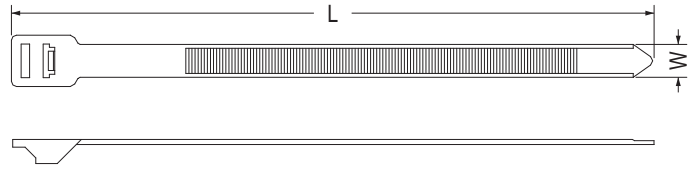

【 Self-Locking Tie 】

Part No.	Approx. Length mm(in)	Approx. Width mm(in)	Max. Bundle mm(in)	Min. Loop Tensile Strength kgs.(lbs.)	Package
	L	W			
YJ-228	228(9.00")	12.7(0.50")	54(2.12")	114(250)	100
YJ-256	256(10.00")		62(2.44")		
YJ-279	279(11.00")		70(2.75")		
YJ-305	305(12.00")		78(3.07")		
YJ-328	328(13.00")		86(3.38")		
YJ-355	355(14.00")		94(3.70")		
YJ-380	380(15.00")		102(4.00")		
YJ-405	405(16.00")		110(4.33")		
YJ-430	430(17.00")		118(4.64")		
YJ-455	455(18.00")		127(5.00")		
YJ-485	485(19.00")		135(5.31")		
YJ-510	510(20.00")		143(5.62")		
YJ-534	534(21.00")		151(5.94")		
YJ-560	560(22.00")		159(6.25")		
YJ-585	585(23.00")		167(6.57")		
YJ-610	610(24.00")		175(6.88")		
YJ-635	635(25.00")		183(7.20")		
YJ-660	660(26.00")		191(7.51")		
YJ-685	685(27.00")		199(7.83")		
YJ-710	710(28.00")		207(8.14")		
YJ-735	735(29.00")	215(8.46")			
YJ-760	760(30.00")	224(8.81")			
YJ-790	790(31.00")	232(9.13")			
YJ-813	813(32.00")	243(9.57")			
YJ-915	915(36.00")	274(10.79")			
YJ-1042	1042(41.00")	314(12.36")			

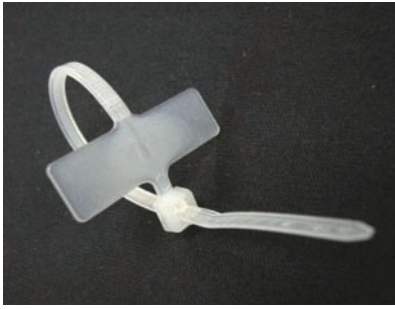

- Material: Nylon 66 (UL)
- Flame Class: 94V-2
- Color: Natural/Black
- Unit: mm
- UL Recognized

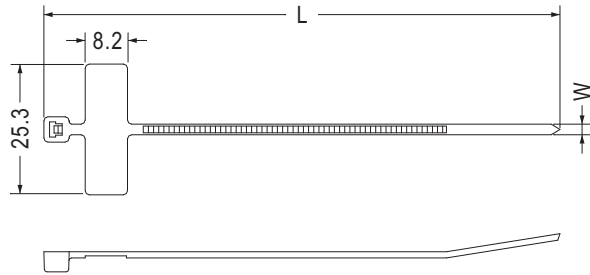

【 Marker Tie 】

Part No.	Approx. Length	Approx. Width	Max. Bundle	Min. Loop	Package
	mm(in)	mm(in)			
	L	W		kgs.(lbs.)	
YJ-98X	100(4.00")	2.5(0.10")	22(0.87")	8(18)	500

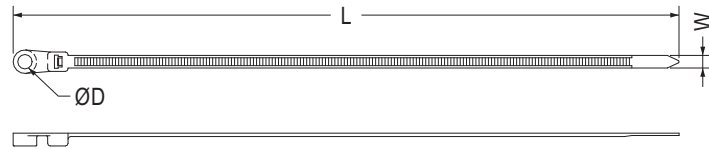

【 Clamp Mounting Tie 】

Part No.	D	Approx. Length	Approx. Width	Max. Bundle	Min. Loop	Package
		mm(in)	mm(in)			
		L	W		kgs.(lbs.)	
YJ-110	3.2	110(4.33")	2.8(0.11")	23(0.91")	10(22)	500
YJ-156	4.2	156(6.14")	3.6(0.14")	35(1.38")	18(40)	
YJ-205	5.4	205(8.00")	4.8(0.19")	51(2.01")	23(50)	
YJ-255	5.4	255(10.00")	4.8(0.19")	67(2.64")	23(50)	1000
YJ-304	5.4	304(12.00")	4.8(0.19")	83(3.27")	23(50)	500
YJ-356	5.4	356(14.00")	4.8(0.19")	101(3.98")	23(50)	
YJ-406	5.4	406(16.00")	4.8(0.19")	118(4.64")	23(50)	
YJ-230	6.4	230(9.00")	7.6(0.30")	58(2.28")	54(120)	100
YJ-306	6.4	306(12.00")	7.6(0.30")	84(3.31")	54(120)	
YJ-381	6.4	381(15.00")	7.6(0.30")	108(4.25")	54(120)	
YJ-460	6.4	460(18.00")	7.6(0.30")	133(5.24")	54(120)	
YJ-535	6.4	535(21.00")	7.6(0.30")	155(6.10")	54(120)	

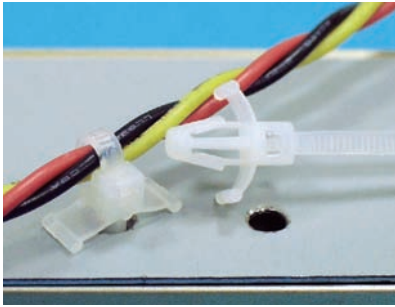

- Material: Nylon 66 (UL)
- Flame Class: 94V-2
- Color: Natural/Black
- Unit: mm
- UL Recognized

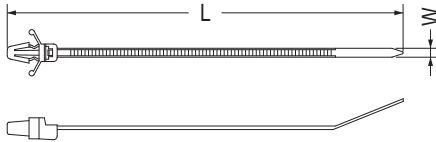

[GTP-130ST, GTP-170ST, GTP-190ST, GTP-110M]

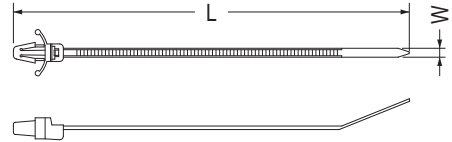

[GTP-110MA]

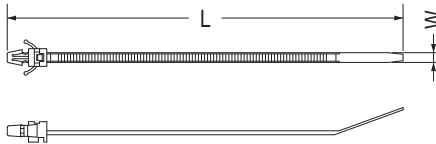

[GTP-130I]

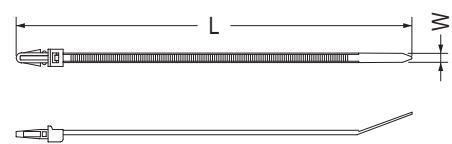

[GTP-150I, GTP-200ST]

Part No.	Approx. Length mm(in)	Approx. Width mm(in)	Max. Bundle mm(in)	Min. Loop Tensile Strength kgs.(lbs.)	Hole Diameter Chassis mm(in)	Max. Panel Thickness mm(in)	Package
	L	W					
GTP-130ST	132(5.12")	4.8(0.19")	25(0.98")	22.2(50)	6.4(0.252")	3.2(0.126")	1000
GTP-170ST	175(6.69")	4.8(0.19")	38(1.50")	22.2(50)	6.4(0.252")	3.2(0.126")	
GTP-190ST	200(7.68")	4.8(0.19")	45(1.77")	22.2(50)	6.4(0.252")	3.2(0.126")	
GTP-110M	110(4.33")	2.5(0.10")	22(0.87")	8.1(18)	4.8~5.0 (0.189")~(0.197")	0.8~2.4 (0.03")~(0.09")	
GTP-110MA							
GTP-130I	130(5.12")	3.2(0.13")	28(1.10")	13.6(30)	4.0(0.157")	1.0~2.0	
GTP-150I	150(5.91")	3.6(0.14")	32(1.26")	13.6(30)	5.2(0.205")	1.0~2.8	
GTP-200ST	200(7.87")	4.8(0.19")	46(1.81")	22.2(50)	6.3(0.248")	3.6(0.141")	



- Material: Nylon 66 (UL)
- Flame Class: 94V-2
- Color: Natural/Black
- Unit: mm

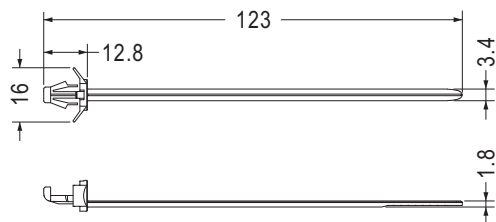

MOUNTING HOLE Ø5.4
THICKNESS 2.0~3.2

Part No.	Package
STCC-123	500

電線束線帶 CABLE TIE

用途：捆紮電線、物品，此系列為可重複性使用。

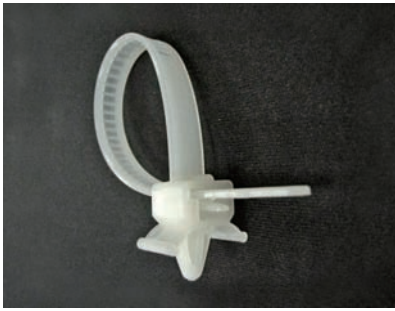

- Material: Nylon 66 (UL)
- Flame Class: 94V-2
- Color: Natural/Black
- Unit: mm

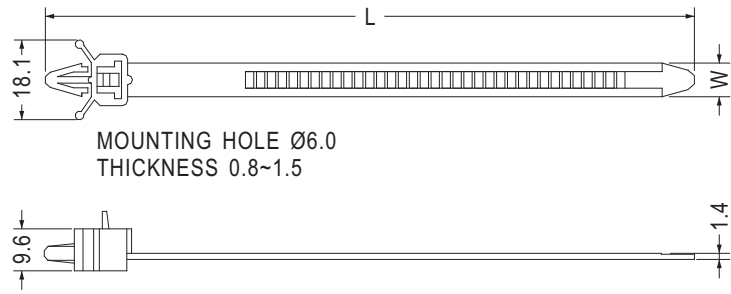

【 Push Releasable Tie 】

Part No.	Approx. Length mm(in)	Approx. Width mm(in)	Max. Bundle mm(in)	Min. Loop Tensile Strength kgs.(lbs.)	Package
	L	W			
YJ-R151	151(6.00")	7.8(0.30")	37(1.45")	40(88)	100
YJ-R191	191(7.50")		49(1.92")		
YJ-R231	231(9.00")		62(2.44")		

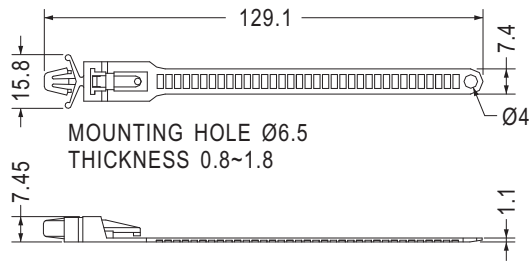

Part No.	Package
KYCB-129	250



- Material: Nylon 66 (UL)
- Flame Class: 94V-2
- Color: Natural/Black
- Unit: mm

用途：捆紮電線、物品。

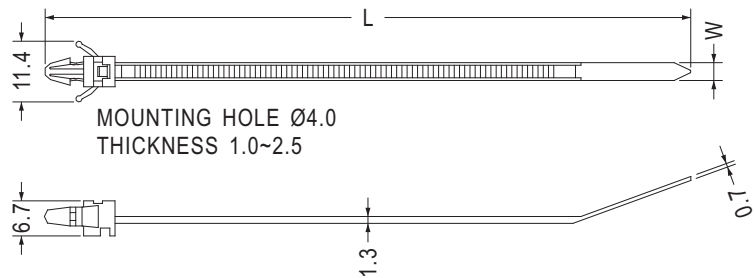

【 Push Self-Locking Tie 】

Part No.	Approx. Length mm(in)	Approx. Width mm(in)	Max. Bundle mm(in)	Min. Loop Tensile Strength kgs.(lbs.)	Package
	L	W			
YJ-123	123(4.84")	3.4(0.13")	25.4(1.00")	18(40)	500

電源線收線帶 STRAP TIE

用途：捆紮電線、物品。

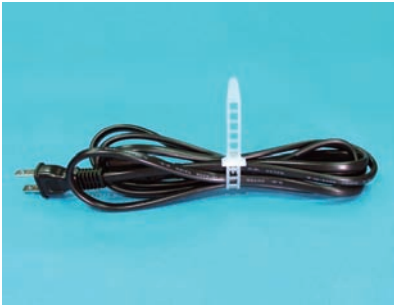

- Material: Nylon 66 (UL)/PE
- Flame Class: 94V-2
- Color: Natural/Black
- Unit: mm

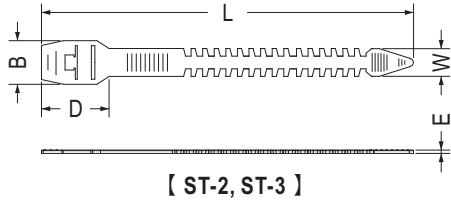
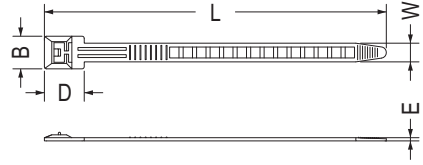

Part No.	B	D	E	L	W	Package
ST-1SN	15.0	18.3	1.5	157.0	8.6	500
ST-1	15.0	18.3	1.5	157.0	8.6	
ST-2	15.8	21.4	1.2	135.0	10.0	
ST-3	15.4	24.5	1.2	140.0	10.0	
ST-4	15.0	18.3	1.7	205.0	8.6	
ST-5	13.0	16.0	1.45	125.0	7.5	
ST-5NS	13.0	16.0	1.0	125.0	7.5	
ST-11N	15.0	18.3	1.7	300.0	8.6	



- Material: TPE
- Color: Black/Blue
- Unit: mm

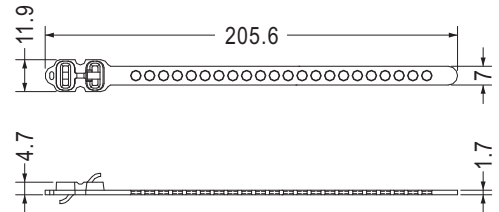

Part No.	Package
ST-6	250

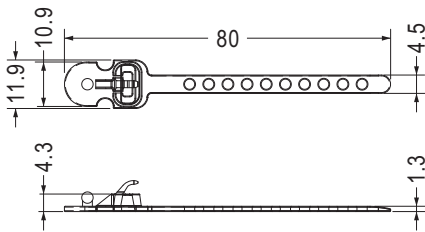

Part No.	Package
ST-13	500

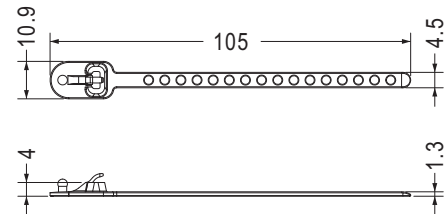

Part No.	Package
ST-15	500



- Material: PE
- Color: Natural/Black
- Unit: mm

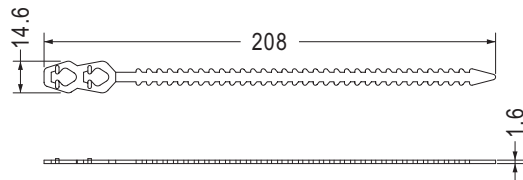

Part No.	Package
ST-7	500

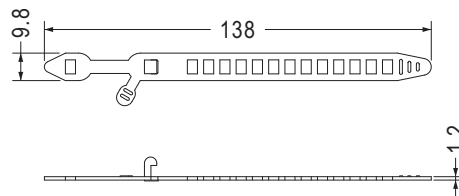

Part No.	Package
ST-8	500

珠型束線帶 STRAP TIE

用途：捆紮電線、物品。



- Material: PP (UL)
- Flame Class: 94HB
- Color: Natural/Black
- Unit: mm

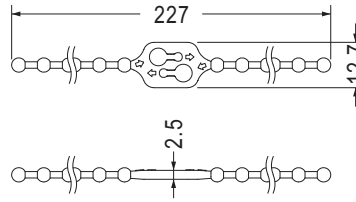

Part No.	Package
ST-23	200



- Material: Nylon 66 (UL)
- Flame Class: 94V-2/94V-0
- Color: Natural/Black
- Unit: mm

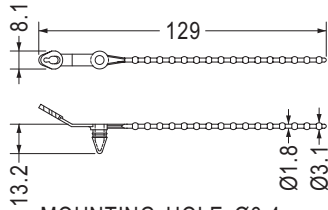

MOUNTING HOLE Ø6.4
THICKNESS 0.8~1.6

Part No.	Package
ST-9	500

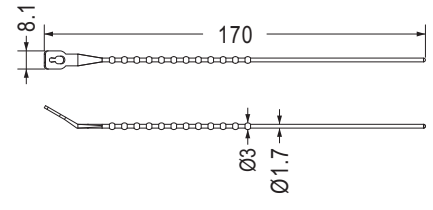

Part No.	Package
ST-19	500

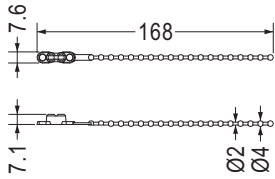

- Material: PE
- Color: Natural

Part No.	Package
STO-166	500

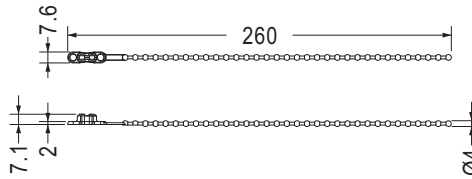

- Material: PE
- Color: Natural

Part No.	Package
STO-260	500

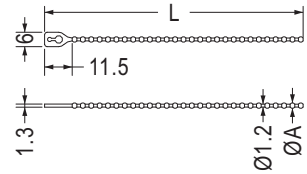

Part No.	A	L	Package
GTB-70	2.4	70.0	1000
GTB-100	2.3	112.0	1000

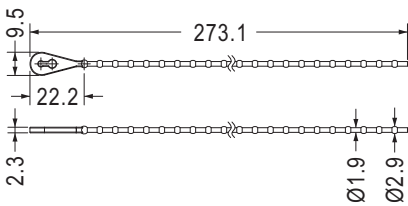

- Material: PP
- Color: Natural

Part No.	Package
GTBA-273	500

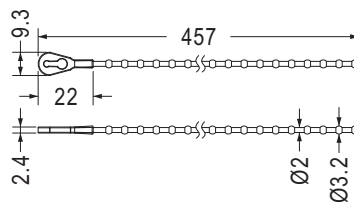

- Material: PP (UL)
- Flame Class: 94HB
- Color: Natural

Part No.	Package
GTBA-457	500

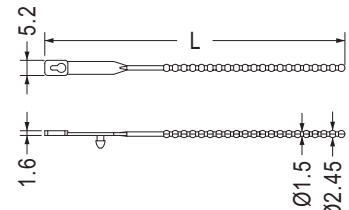

MOUNTING HOLE Ø3.0
THICKNESS 0.6~1.8

Part No.	L	Package
GTB-85	85.0	1000
GTB-103	103.0	1000

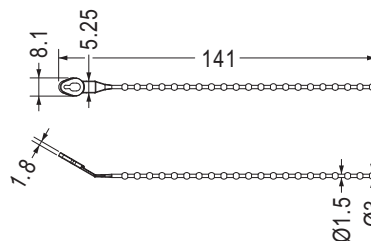

Part No.	Package
GTBA-141	500

電線束線帶 CABLE TIE

用途：捆紮電線、物品。

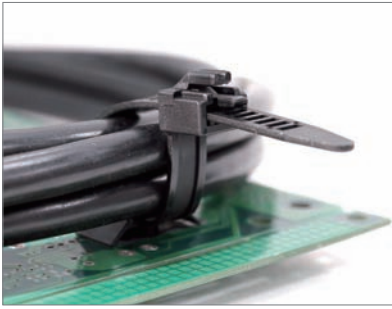

- Material: Nylon 66 (UL)
- Flame Class: 94V-2/94V-0
- Color: Natural/Black
- Unit: mm

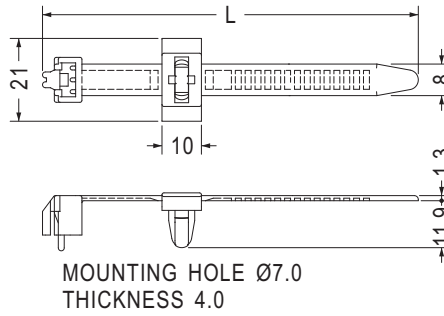

Part No.	L	Package
STC-115	115.3	200
STC-175	175.0	

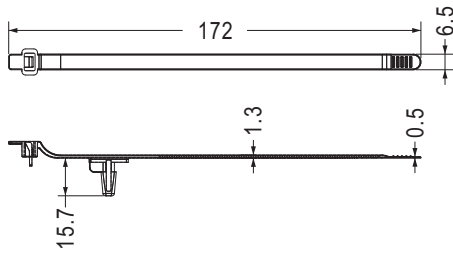

Part No.	Package
STC-173	200

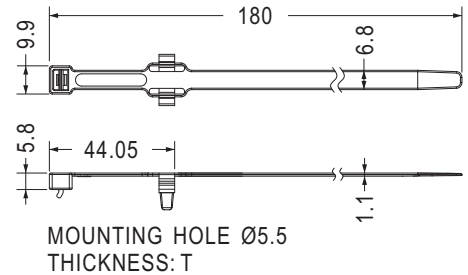
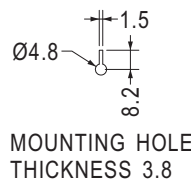

Part No.	T	Package
STC-180	0.8~2.0	200
STC-180L	2.3~2.5	

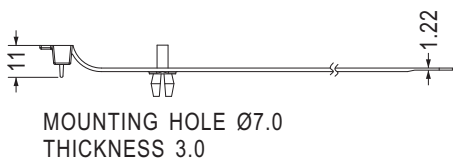

【 STC-171A 】

Part No.	組 合 件 (ASSY)	Package
STC-171	STC-171A+STC-171B	250

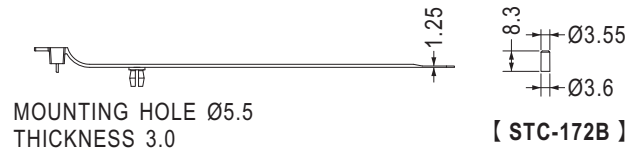
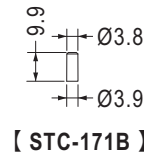

Part No.	Part No.	Package
STC-172	STC-172A	100
	STC-172B	

此為子母包:內容物包含右方零件

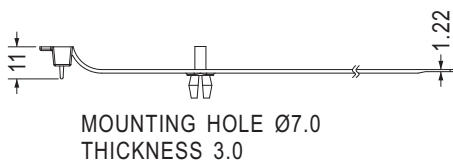

【 STC-174A 】

Part No.	Part No.	Package
STC-174	STC-174A	100
	STC-171B	

此為子母包:內容物包含右方零件

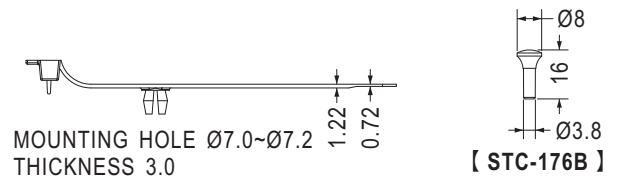
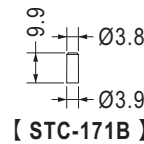

【 STC-121A, STC-176A 】

Part No.	Part No.	L	Package
STC-121	STC-121A	121.0	100
	STC-176B		
STC-176	STC-176A	171.2	100
	STC-176B		

此為子母包:內容物包含右方零件

電線束線帶 CABLE TIE

用途：捆紮電線、物品。

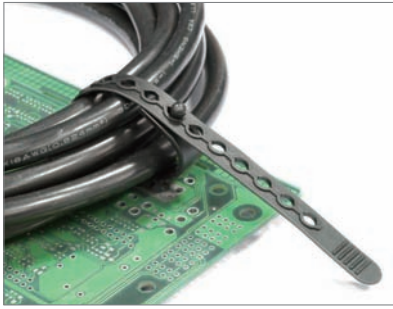

- Material: PE
- Color: Black
- Unit: mm

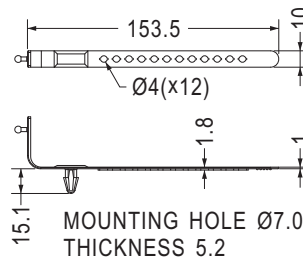

Part No.	Package
STCA-161	200

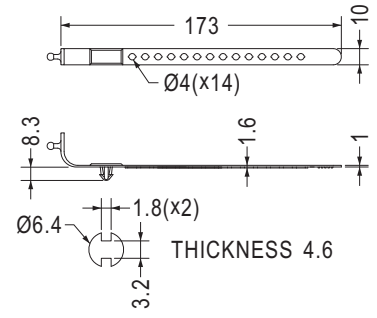

Part No.	Package
STCA-172	500



- Material: Nylon 66 (UL)
- Flame Class: 94V-2/94V-0
- Color: Natural/Black
- Unit: mm

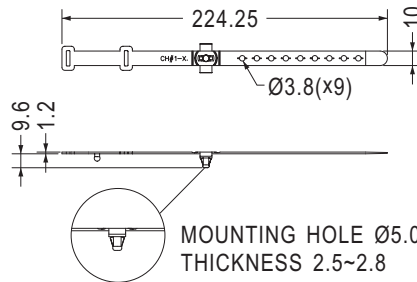

Part No.	Package
STCA-224	200

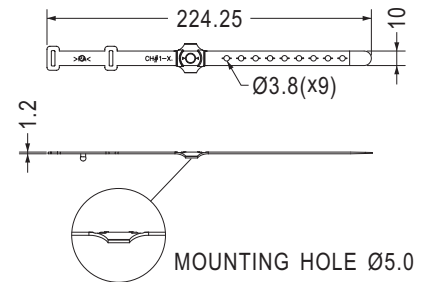

Part No.	Package
STCA-225	200

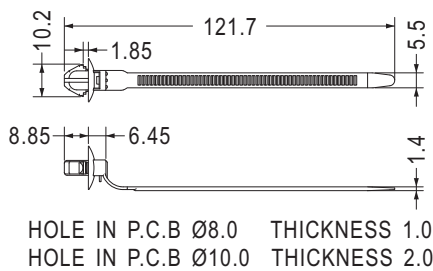

Part No.	Package
STCB-110	500

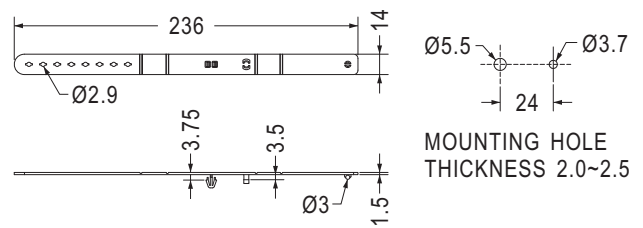

Part No.	Package
STCA-235	500

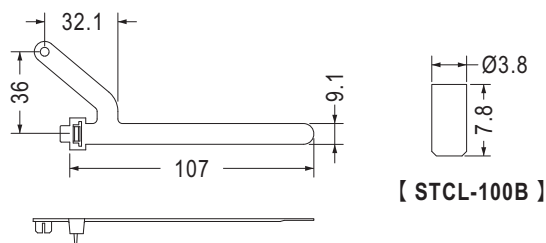

Part No.	組合物(ASSY)	Package
STCL-100	STCL-100A+STCL-100B	100

電源線束線帶 STRAP TIE

用途：捆紮電線、物品。

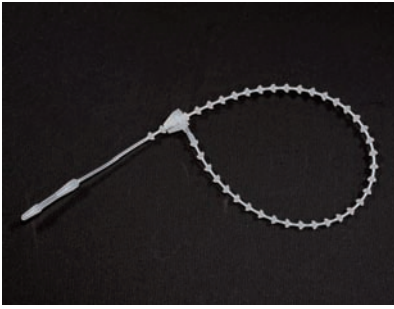

- Material: Nylon 66 (UL)
- Flame Class: 94V-2/94V-0
- Color: Natural/Black
- Unit: mm

- Material: PP
- Color: Natural
- Unit: mm

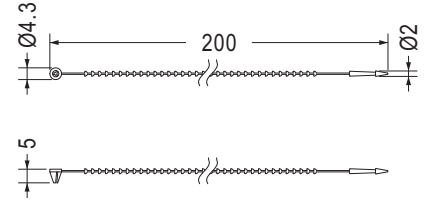
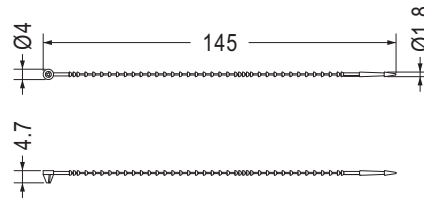

Part No.	Package
LOCK-145	1000

Part No.	Package
LOCK-200	1000

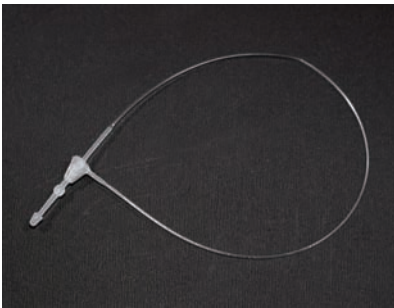

- Material: PP
- Color: Natural
- Unit: mm

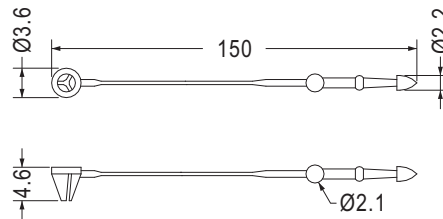

Part No.	Package
LOCK-150	1000

5

水管座 PIPE MOUNT TIE

用途：車用管材之固定。



- Material: Nylon 66 (UL)
- Flame Class: 94V-2/94V-0
- Color: Black
- Unit: mm

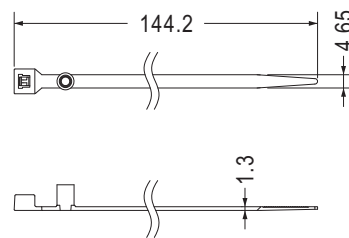

【 SWPK-15A 】

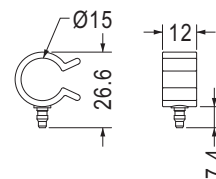

【 SWPK-1B 】

Part No.	組零件(ASSY)	Package
SWPK-15F	SWPK-15A+SWPK-1B	100

吊勾 HANDLE GRIP

用途：用於電線之固定。

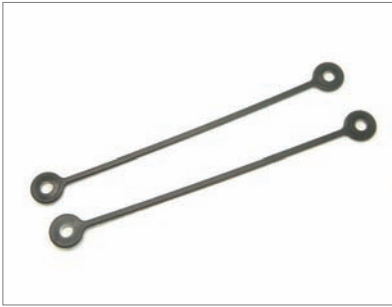

- Material: PE
- Color: White/Black
- Unit: mm

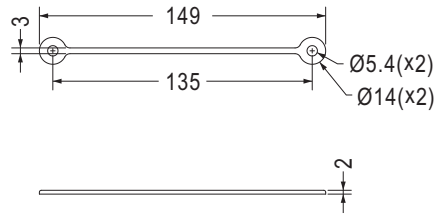

Part No.	Package
SFA-1	1000

束線座 CABLE MOUNT

用途：配合寬度2.5mm束線帶，可固定電線於機板上。

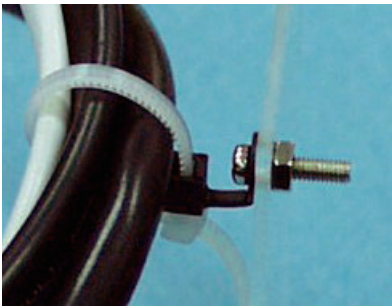

- Material: Nylon 66 (UL)
- Flame Class: 94V-2/94V-0
- Color: Natural/Black
- Unit: mm

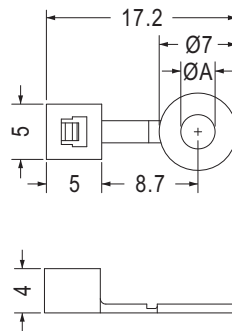

Part No.	A	Package
ASUS-1	2.8	2000
ASUS-3	3.1	

束線帶扣 CABLE TIE BUCKLE

用途：用於束線帶定位與固定用。

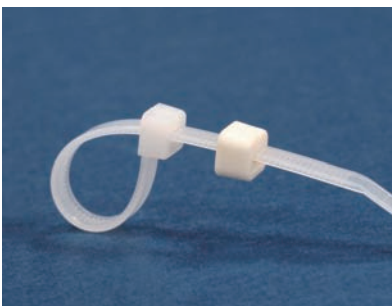

- Material: Nylon 66 (UL)
- Flame Class: 94V-2/94V-0
- Color: Natural/Black
- Unit: mm

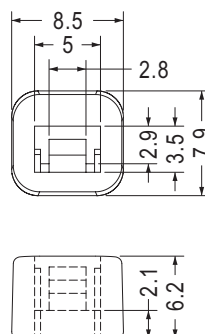

Part No.	Package
YJHH-4.8	1000

黏扣帶 VELCRO

用途：捆紮電線、物品。

依不同尺寸，可接受訂製。
Different size available per request.



- Material: Nylon/Nylon(UL)
- Flame Class: 94V-2
- Color: Black
- Unit: mm

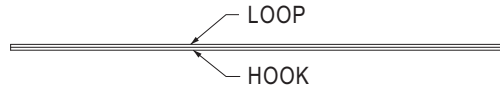
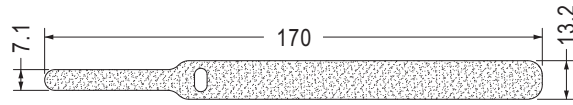

Part No.	Package
VCO-7NL	500

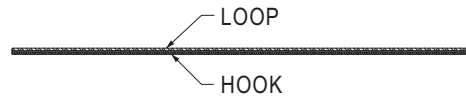
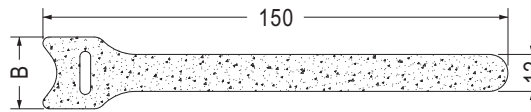
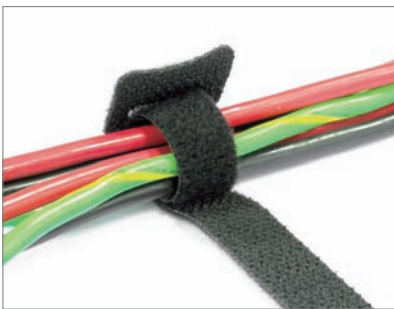

Part No.	B	Package
VCO15023	23.3	500
VCO-39	24.0	

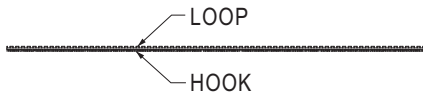
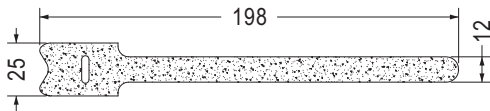

Part No.	Package
VCO19812	500

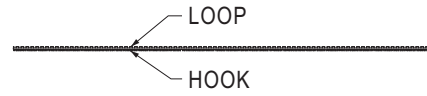
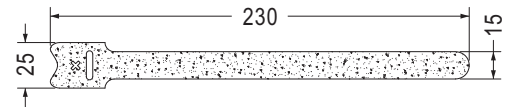

Part No.	Package
VCO23015	500

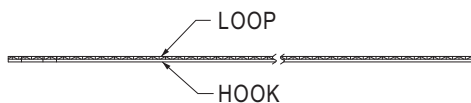
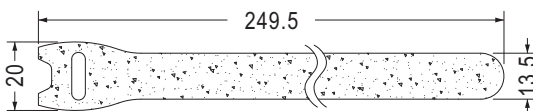

Part No.	Package
VCO25020	500

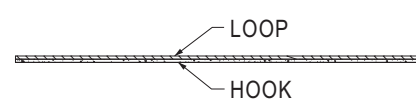
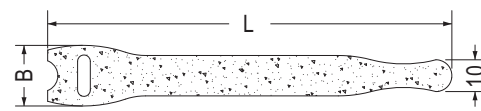

Part No.	B	L	Package
VCO-888	19.1	127.0	500
VCO-888-1	19.1	155.0	
VCO-888-2	19.05	95.0	

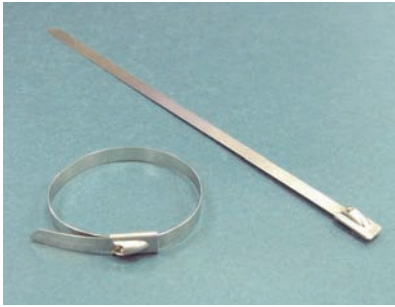

- Material: SUS
- Unit: mm

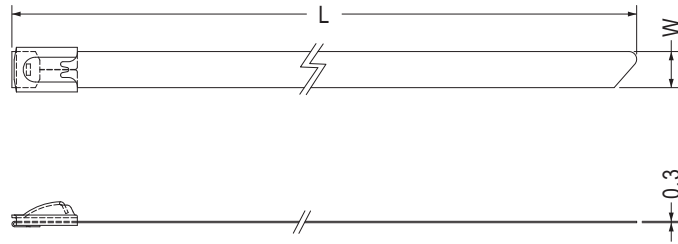

【 Self-Locking Tie 】

Part No.	Max. Bundle mm(in)	Approx. Length mm(in)	Approx. Width mm(in)	Min. Loop Tensile Strength kgs.(lbs.)	Package
		L	W		
STB-152S	25(1.00")	152(6.00")	4.5(0.177")	45.3(100)	100
STB-200S	50(2.00")	200(8.00")			
STB-360S	102(4.00")	360(14.0")			
STB-520S	152(6.00")	520(20.0")			
STB-680S	203(8.00")	680(27.0")			
STB-840S	254(10.0")	840(33.0")			
STB-1050S	318(12.5")	1050(41.0")			50

Part No.	Max. Bundle mm(in)	Approx. Length mm(in)	Approx. Width mm(in)	Min. Loop Tensile Strength kgs.(lbs.)	Package
		L	W		
STB-152M	25(1.00")	152(6.00")	8.0(0.315")	113.3(250)	100
STB-200M	50(2.00")	200(8.00")			
STB-360M	102(4.00")	360(14.0")			
STB-520M	152(6.00")	520(20.0")			
STB-680M	203(8.00")	680(27.0")			
STB-840M	254(10.0")	840(33.0")			
STB-1050M	318(12.5")	1050(41.0")			50

Part No.	Max. Bundle mm(in)	Approx. Length mm(in)	Approx. Width mm(in)	Min. Loop Tensile Strength kgs.(lbs.)	Package
		L	W		
STB-290L	80(3.10")	290(11.0")	12.0(0.472")	272.0(600)	50
STB-360L	102(4.00")	360(14.0")			
STB-430L	121(4.70")	430(17.0")			
STB-520L	152(6.00")	520(20.0")			
STB-600L	175(6.80")	600(24.0")			
STB-680L	203(8.00")	680(27.0")			
STB-750L	230(8.70")	750(30.0")			
STB-840L	254(10.0")	840(33.0")			
STB-910L	273(10.7")	910(36.0")			
STB-1000L	302(11.9")	1000(39.0")			25
STB-1070L	325(12.8")	1070(42.0")			
STB-1200L	351(13.8")	1200(47.0")			

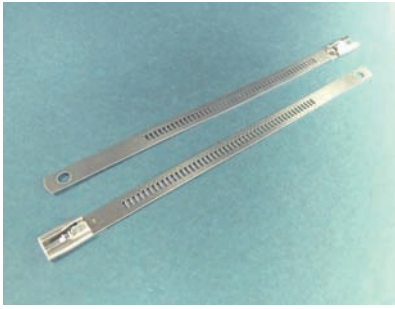

- Material: SUS
- Unit: mm

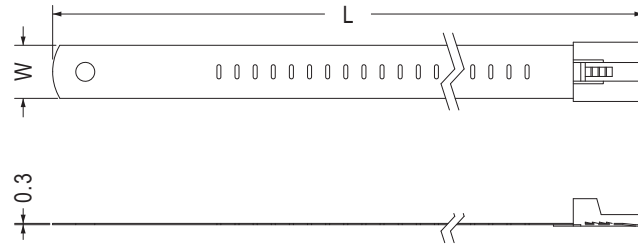

【 Self-Locking Tie 】

Part No.	Max. Bundle mm(in)	Approx. Length mm(in)	Approx. Width mm(in)	Min. Loop Tensile Strength kgs.(lbs.)	Package
		L	W		
STL-150S	22(0.86")	150(5.90")	7.0(0.28")	113.4(250)	100
STL-195S	45(1.70")	195(8.00")			
STL-255S	64(2.50")	255(10.0")			
STL-335S	89(3.50")	335(13.0")			
STL-490S	139(5.40")	490(19.0")			
STL-635S	185(7.20")	635(25.0")			

Part No.	Max. Bundle mm(in)	Approx. Length mm(in)	Approx. Width mm(in)	Min. Loop Tensile Strength kgs.(lbs.)	Package
		L	W		
STL-150M	22(0.86")	150(5.90")	12.0(0.472")	113.4(250)	100
STL-195M	45(1.70")	195(8.00")			
STL-255M	64(2.50")	255(10.0")			
STL-335M	89(3.50")	335(13.0")			50
STL-490M	139(5.40")	490(19.0")			100
STL-635M	185(7.20")	635(25.0")			

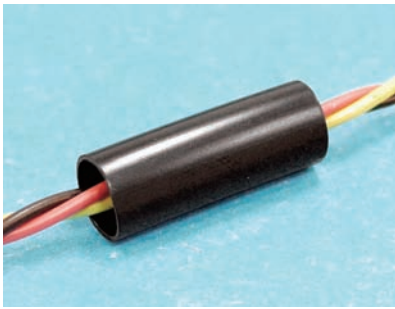

- Material: P.V.C (UL)
- Flame Class: VW-1
- Color: Black/Transparent
- Unit: mm

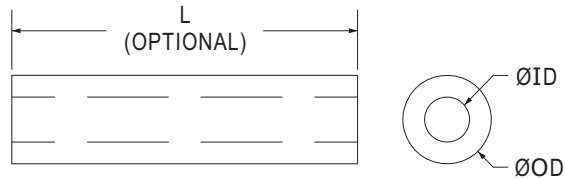

Package			
Part No.	Feet/1 Roll	M/1 Roll	mm/1 Roll
P0.864~P5.94	1000	304.8	304800
P6.68~P11.1B	500	152.4	152400
P12.7B			
P11.1	250	76.2	76200
P12.7			

Part No.	Size AWG	Inside Diameter	Cat.No. DEV-300(300V.105°C)			Cat.No. DEV-600 (600V.105°C)		
			Outside Diameter	Average Thickness	Min. Thickness At Any Point	Outside Diameter	Average Thickness	Min. Thickness At Any Point
P0.864	20	0.864	1.70	0.40	0.330	2.10	0.60	0.431
P0.965	19	0.965	1.80	0.40	0.330	2.20		
P1.067	18	1.067	1.90	0.40	0.330	2.30		
P1.19	17	1.19	2.00	0.40	0.330	2.60		
P1.34	16	1.34	2.15	0.40	0.330	2.75		
P1.50	15	1.5	2.30	0.40	0.330	2.90		
P1.68	14	1.68	2.50	0.40	0.330	3.10		
P1.93	13	1.93	2.70	0.40	0.330	3.35		
P2.16	12	2.16	3.00	0.40	0.330	3.60		
P2.41	11	2.41	3.20	0.40	0.330	3.80		
P2.69	10	2.69	3.50	0.40	0.330	4.10	0.70	0.559
P3.00	9	3.00	4.10	0.55	0.431	4.40		
P3.38	8	3.38	4.50	0.55	0.431	4.80		
P3.76	7	3.76	4.90	0.55	0.431	5.20		
P4.22	6	4.22	5.35	0.55	0.431	5.65		
P4.72	5	4.72	5.85	0.55	0.431	6.15		
P5.28	4	5.28	6.40	0.55	0.431	6.70		
P5.94	3	5.94	7.05	0.55	0.431	7.35		
P6.68	2	6.68	7.80	0.55	0.431	8.10		
P7.47	1	7.47	8.60	0.55	0.431	8.90		
P8.38	0	8.38	9.50	0.55	0.431	9.80		
P7.92	5/16"	7.92				9.35		
P9.53	3/8"	9.53				10.95		
P11.1	7/16"	11.10				12.50		
P12.7	1/2"	12.70				14.10		

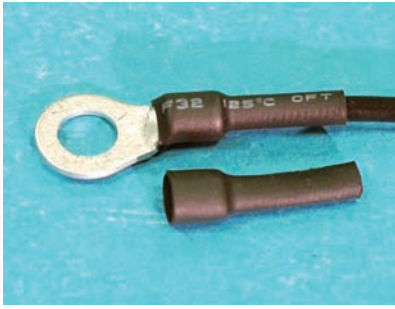

- Material: Polyolefin (UL)
- Flame Class: VW-1
- Color: Black
- Unit: mm

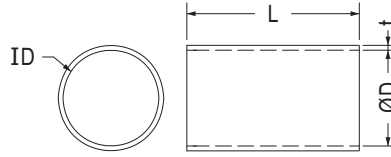

Part No.	收縮前狀態 Dimensions Before Shrinkage		收縮後狀態 Dimensions After Shrinkage		Package	
	內徑(D) Inside Dia.	管壁厚度(t) Thickness	內徑 Inside Dia.	管壁厚度(t) Thickness	M/1 Roll	mm/1 Roll
Ø1.0	1.3	0.2	0.5	0.33	200	200000
Ø1.5	2.0	0.2	0.75	0.36		
Ø2.0	2.5	0.2	1.0	0.44		
Ø2.5	3.0	0.25	1.25	0.44		
Ø3.0	3.5	0.25	1.5	0.44		
Ø3.5	4.0	0.25	1.75	0.44		
Ø4.0	4.5	0.25	2.0	0.44		
Ø5.0	5.4	0.25	2.5	0.56	100	100000
Ø6.0	6.4	0.25	3.0	0.56		
Ø7.0	7.4	0.25	3.5	0.56	50	50000
Ø8.0	8.4	0.25	4.0	0.56		
Ø9.0	9.4	0.25	4.5	0.56		
Ø10.0	10.4	0.25	5.0	0.56		
Ø11.0	11.4	0.25	5.5	0.56		
Ø12.0	12.4	0.25	6.0	0.56		
Ø13.0	13.5	0.3	6.5	0.69		
Ø14.0	14.5	0.3	7.0	0.69		
Ø15.0	15.5	0.3	7.5	0.69		
Ø16.0	16.8	0.3	8.0	0.69		
Ø18.0	18.7	0.35	9.0	0.77		
Ø20.0	21.2	0.35	10.0	0.77		
Ø22.0	23.2	0.4	11.0	0.77		
Ø25.0	26.1	0.4	12.5	0.87		
Ø28.0	29.0	0.5	14.0	0.87		
Ø30.0	32.0	0.5	14.8	0.87		
Ø35.0	37.0	0.5	17.5	0.87		
Ø40.0	43.0	0.5	20.0	0.97		
Ø50.0	53.0	0.5	24.7	0.97		

織布管 SILICON FIBERGLASS SLEEVING

用途：用於電線之絕緣。

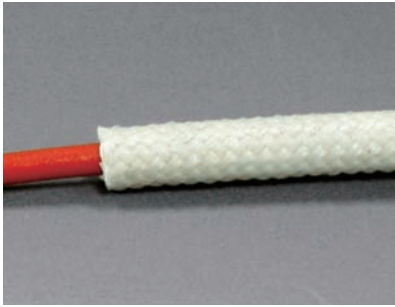

- Material: Glass-Fiber
- Color: White
- Unit: mm

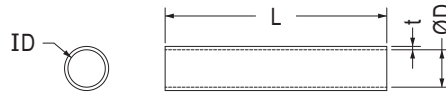

Part No.	內徑(D) Inside Diameter	管壁厚度(t) Thickness	Package	
			M/1 Roll	mm/1 Roll
T1	1.0	0.28	200	200000
T2	2.0	0.28		
T3	3.0	0.28		
T4	4.0	0.30	100	100000
T5	5.0	0.30		
T6	6.0	0.30		
T7	7.0	0.30		
T8	8.0	0.35	50	50000
T9	9.0	0.35		
T10	10.0	0.35		
T12	12.0	0.36		
T14	14.0	0.36		
T16	16.0	0.36		

5

護線套 MOVEABLE BUSHING

用途：用於電線出線口，防止電線機殼刮傷。



- Material: Nylon 6
- Color: Natural
- Unit: mm

- Material: Nylon 6 (UL)
- Flame Class: 94V-2

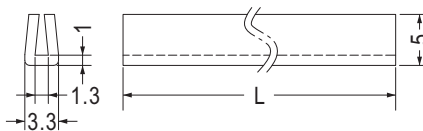

CHASSIS THICKNESS 0.8~1.2

Part No.	L	Package
KGA13-185	185.0	500
KGA13-260	260.0	

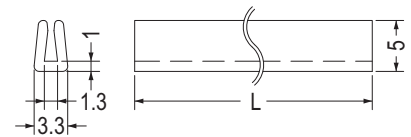

CHASSIS THICKNESS 1.0~1.2

Part No.	L	Package
KGC-013-45	45.0	500
KGC-013-70	70.0	



- Material: Nylon 66 (UL)
- Flame Class: 94V-2/94V-0
- Color: Natural
- Unit: mm

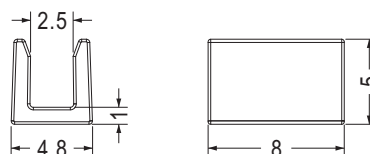

Part No.	Package
KGC-025-8	1000

活用護線套 MOVEABLE BUSHING

用途：用於電線出線口，防止電線機殼刮傷。

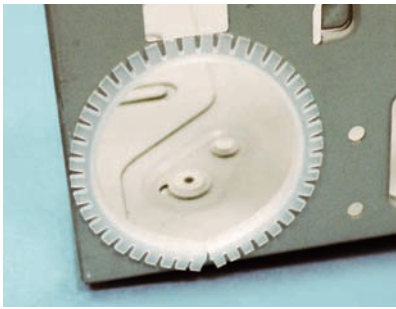

- Material: PE
- Color: Natural
- Unit: mm

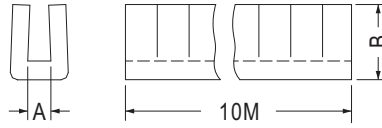

切型
【KG-16S】

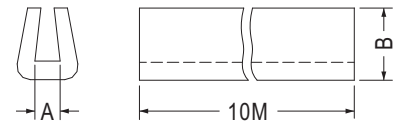

平面型
【KG-016C】

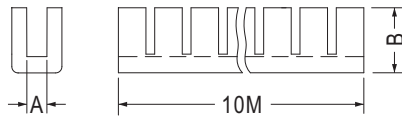

THICKNESS: T

Part No.	A	B	T	Length L (M)
KG-010	1.1	5.2	0.9~1.1	10
KG-012	1.3	5.4	1.1~1.3	
KG-016	1.7	5.4	1.45~1.75	
KG-016S	1.6	5.3	1.45~1.75	
KG-016C	1.7	5.4	1.45~1.75	
KG-020	2.2	5.4	1.8~2.2	
KG-024	2.7	5.7	2.25~2.6	
KG-030	3.3	6.1	2.85~3.25	
KG-040	4.3	6.5	3.85~4.25	



- Material: Nylon 66 (UL)
- Flame Class: 94V-2/94V-0
- Color: Natural
- Unit: mm

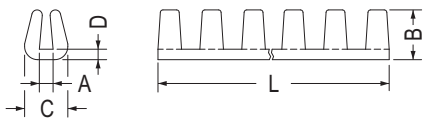

CHASSIS THICKNESS: T

Part No.	A	B	C	D	L	T	Package	
KG-006N	0.6	3.8	3.1	0.8	260.0	0.5~0.7	500	
KG-008N	0.8	3.8	3.1	0.8	260.0	0.7~0.9		
KG-010N	1.0	3.8	3.3	0.8	260.0	0.9~1.1		
KG-012N	1.2	3.8	3.5	0.8	260.0	1.1~1.3		
KG-014N	1.4	3.8	3.65	0.8	260.0	1.3~1.5		
KG-014N-290	1.4	3.8	3.65	0.8	290.0	1.3~1.5		
KG-016N	1.6	3.8	3.9	0.8	260.0	1.4~1.7		
KG-016LN	1.6	5.3	4.5	0.8	256.0	1.0~1.5		
KG-016LV-2600	1.6	5.3	4.5	1.4	260.0	1.0~1.5		
KG-020N	2.0	3.8	4.3	0.8	260.0	1.8~2.0		
KG-025N	2.5	3.8	4.8	0.8	260.0	2.0~2.5		
KG-030N	3.0	4.8	6.2	0.8	260.0	2.5~3.0		250

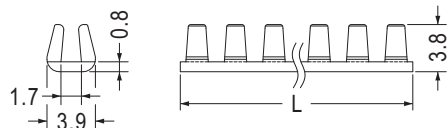

APPLICABLE BOARD THICKNESS 1.4~1.7

Part No.	L	Package
KG-016N-0180	18.0	1000
KG-016N-0930	93.0	500
KG-016N-1080	108.0	

黏貼標誌貼紙 WIRE LABEL

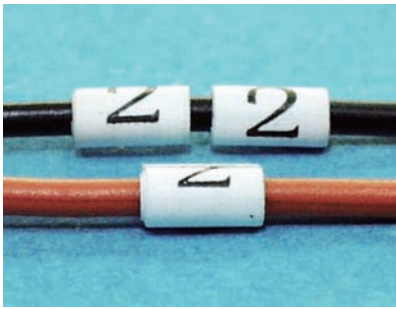

- Material: Vinyl Chloride
- Identical Mark: 0~9 A~Z
- Unit: mm
- 100 pcs of 1 digit on one sheet.

用途：軟式背膠，上印有文字，數字及符號可貼於不同規格電線電纜上，做為電線之標示。

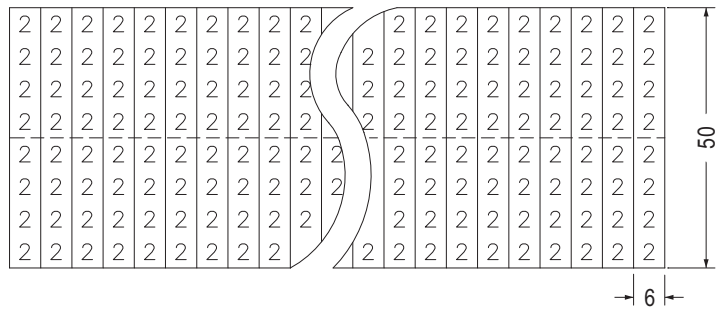

捲式保護帶 SPIRAL WRAPPING BAND

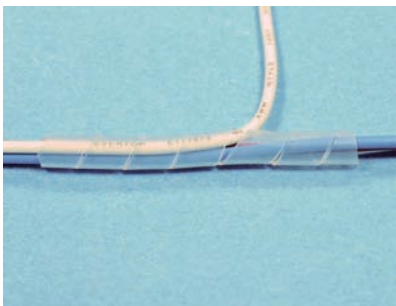

- Material: PE
- Color: Natural
- Unit: mm

用途：引導電線彎曲，電線不易磨損，外觀整齊美觀。

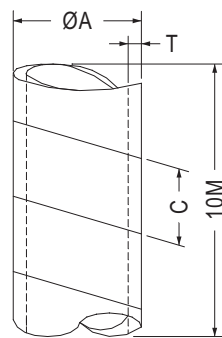

Part No.	A	C	T	Length L (M)
SWB-2	3.0	4.6	0.4	10
SWB-3	4.0	7.6	0.5	
SWB-4S	5.0	8.5	0.5	
SWB-4	6.0	8.5	0.6	
SWB-6	8.0	13.0	0.7	
SWB-7.5	10.0	13.0	0.8	
SWB-9	12.0	15.0	0.85	
SWB-12	15.0	17.0	1.0	
SWB-16	19.0	19.0	1.2	
SWB-20	24.0	21.0	1.5	

快速捲束帶 FAST SPIRAL WRAPPING BAND AND CLAMP



- Spiral Wrap Material: PE
- Spiral Wrap Color: Natural
- Clamp Material: ABS
- Unit: mm

用途：快速引導包覆電線，電線不易磨損，外觀整齊美觀。

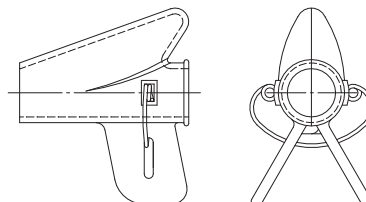

Part No.	The Suitable For Fast Spiral Wrapping Band
KST-08	KYST-8
KST-15	KYST-15
KST-20	KYST-20
KST-25	KYST-25

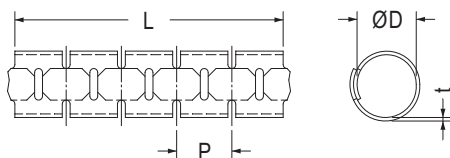

Part No.	Internal ØD (mm)	MAX. DIA (mm)	Pitch P (mm)	Thickness t (mm)	Length L (M)
KYST-08	8.0	10.0	10.0	0.8	5
KYST-15	15.0	16.0	14.0	0.8	
KYST-20	20.0	23.0	17.0	0.9	
KYST-25	25.0	29.0	20.0	1.0	

水平儀 HORIZONTAL TYPE LEVEL

用途：做為水平儀量測，體積小，攜帶方便。



- Body Material: PC+ABS
- Level Material: PMMA
- Magent Material: Magent
- Body Color: White
- Level Color: Transparent
- Magent Material: Natural
- Unit: mm

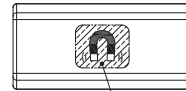
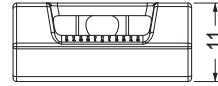
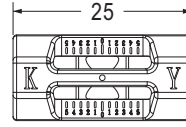

MAGNETIC AREA

NEW

Part No.
KYT-3F



線扣工具 Bushing Tool	Part No. HT-205-1
----------------------	----------------------



進口束線槍 Cable Tie Gun	Part No. TGN-1
------------------------	-------------------



旗型端子工具 Crimp Tool for flag terminal	Part No. KY-1
---	------------------



國產束線槍 Cable Tie Gun	Part No. TGN-2
------------------------	-------------------



非絕緣端子工具 Non-Insulating Terminal Tool	Part No. KY-2
--	------------------



絕緣端子工具 Insulating Terminal Tool	Part No. HT-301H
---------------------------------------	---------------------