

# 6

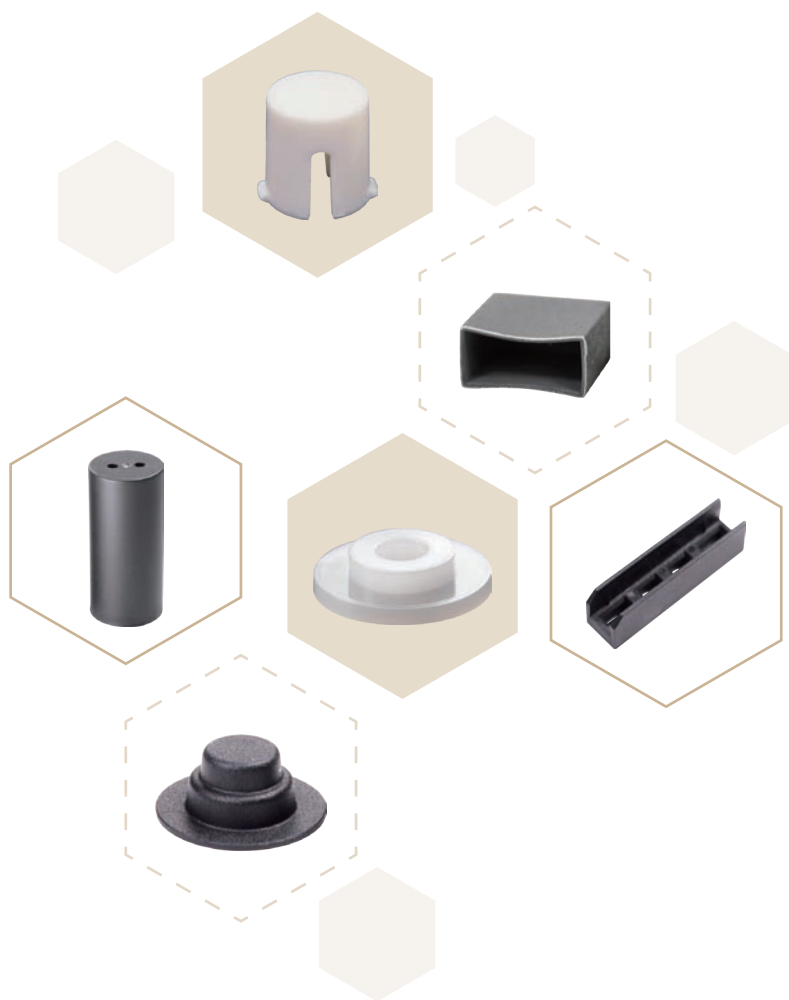

- 電晶體座  
Transistor Housing
- 電晶體墊片  
Transistor Washer
- 零件墊座  
Parts Housing
- 矽膠帽套  
Silicon Insulator Cover
- 軟質端子保護套  
Terminal Soft Sleeves
- 末端套管  
VCP Cap
- 保護蓋  
Insulated Cap
- 開關蓋  
Tact Switch Cap
- 麥克風套  
Mic Holder



# 電晶體蓋 TRANSISTOR COVER

用途：用於TO-220功率晶體，鎖於散熱片上之晶體外殼，絕緣性特佳，防止高壓跳火，耐高溫，提高可靠度增進美觀。

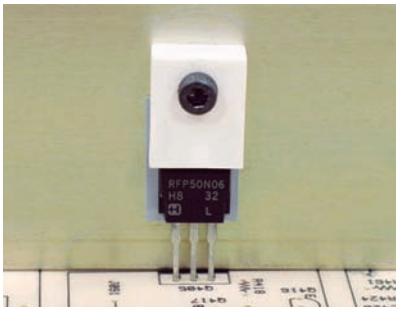

- Material: PBT (UL)/Nylon 66 (UL)
- Flame Class: 94V-2/94V-0
- Color: Natural/Black
- Unit: mm

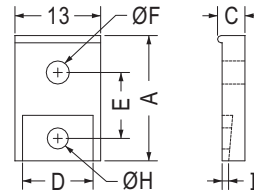

Part No.	A	C	D	E	F	H	I	Package
TC-1	16.0	6.2	10.7	8.0	3.5	3.4	0.8	500
TC-1A	19.3	6.2	10.7	10.0	3.6	3.2	0.8	
TC-1C	17.8	6.3	10.7	9.3	3.5	3.3	0.9	
TC-16	22.5	6.3	10.5	15.0	3.5	3.5	0.8	
TC-18	16.0	6.2	10.7	8.0	3.5	3.5	0.5	

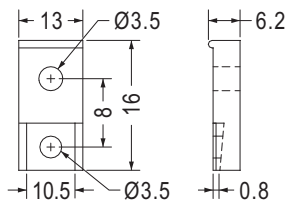

Part No.	Package
TC-5A	500

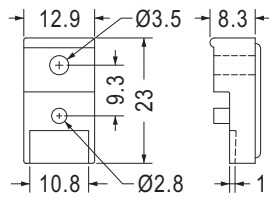

Part No.	Package
TC-9	500

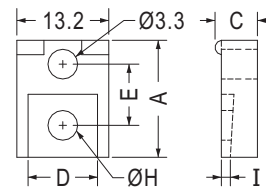

Part No.	A	C	D	E	H	I	Package
TC-6	13.0	6.2	10.7	6.8	3.3	0.8	500
TC-7	13.0	7.0	10.7	6.8	3.0	2.1	
TC-10	14.3	6.2	10.5	8.2	3.2	1.0	
TC-11	14.3	7.0	10.7	8.2	2.7	2.1	
TC-22	13.0	6.7	10.7	7.1	2.8	2.0	
TC-56	14.3	6.2	10.5	8.2	3.2	0.5	

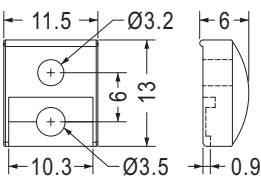

Part No.	Package
TC-46	500

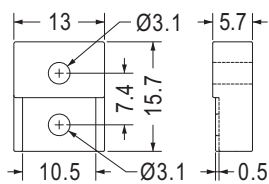

Part No.	Package
TC-75	1000

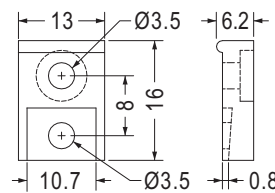

Part No.	Package
TC-4	1000

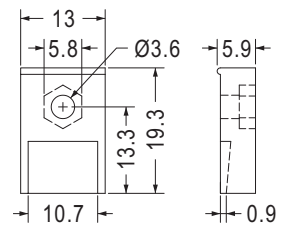

Part No.	Package
TC-21	500

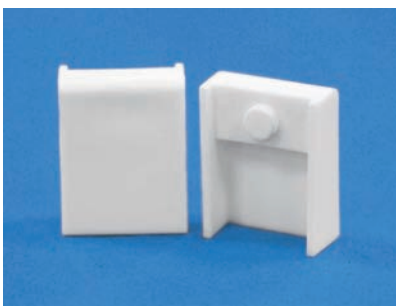

- Material: PBT (UL)
- Flame Class: 94V-0
- Color: Natural
- Unit: mm

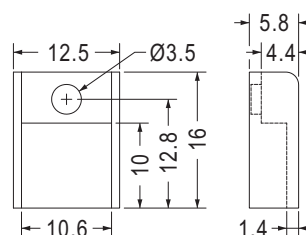

Part No.	Package
TC-58	1000

# 電晶體蓋 TRANSISTOR COVER

用途：用於TO-220功率晶體，鎖於散熱片上之晶體外殼，絕緣性特佳，防止高壓跳火，耐高溫，提高可靠度增進美觀。



- Material: PBT (UL)
- Flame Class: 94V-2/94V-0
- Color: Natural/Black
- Unit: mm

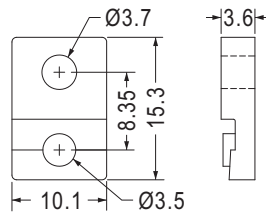

Part No.	Package
TC-49	1000

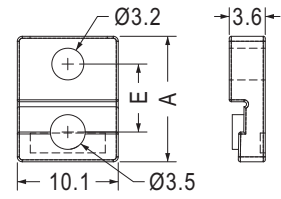

Part No.	A	E	Package
TC-70	12.65	6.85	1000
TC-71	11.45	5.65	



- Material: Nylon 66 (UL)
- Flame Class: 94V-2/94V-0
- Color: Natural
- Unit: mm

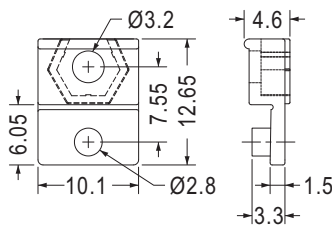

Part No.	Package
TC-77	1000

- Material: PBT(UL)
- Flame Class: 94V-0
- Color: Natural
- Unit: mm

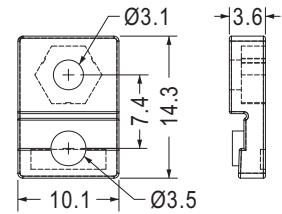

Part No.	Package
TC-50	1000



- Material: Nylon 66 (UL) / PBT (UL)
- Flame Class: 94V-2/94V-0
- Color: Natural
- Unit: mm

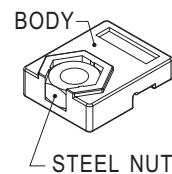
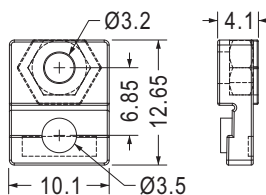

Part No.	Steel Nut	Package
TC-51		1000
TC-76		
TC-76F	M3x0.5P	

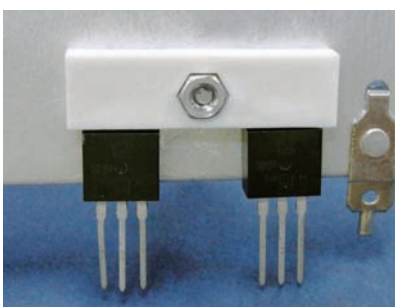

- Material: PBT (UL)
- Flame Class: 94V-0
- Color: Natural
- Unit: mm

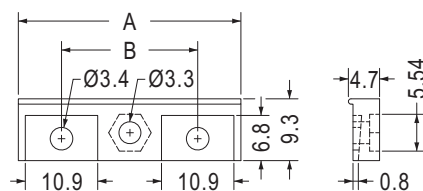

Part No.	A	B	Package
TC-29	33.5	20.5	500
TC-53	34.3	21.7	

# 電晶體蓋 TRANSISTOR COVER

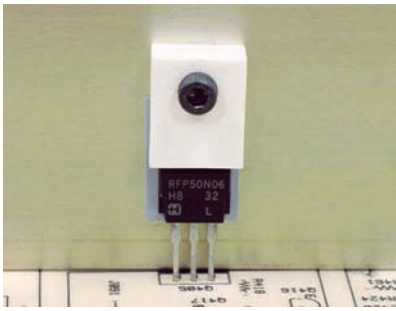

- Material: PBT (UL)
- Flame Class: 94V-0
- Color: Natural/Black
- Unit: mm

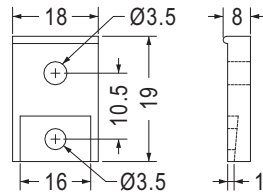

Part No.	Package
TC-2	500

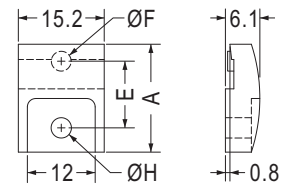

Part No.	A	E	F	H	Package
TC-23	19.1	11.8	3.5	3.6	500
TC-45	22.2	14.9	3.6	3.5	

用途：用於TO-218功率晶體，鎖於散熱片上之晶體外殼，絕緣性特佳，防止高壓跳火，耐高溫，提高可靠度增進美觀。

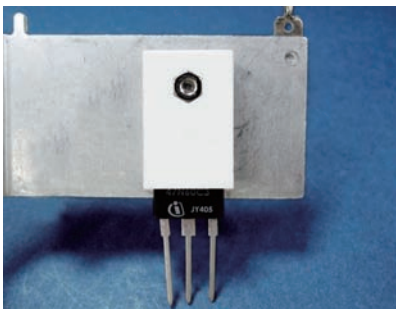

- Material: PBT (UL)
- Flame Class: 94V-0
- Color: Natural
- Unit: mm

用途：用於TO-3P功率晶體，鎖於散熱片上之晶體外殼，絕緣性特佳，防止高壓跳火，耐高溫，提高可靠度增進美觀。

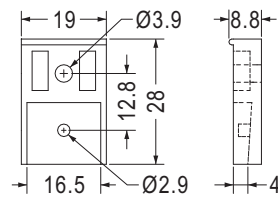

Part No.	Package
TC-3	200

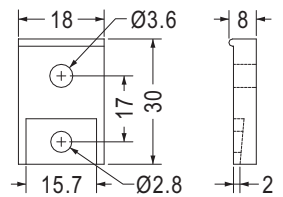

Part No.	Package
TC-19	200

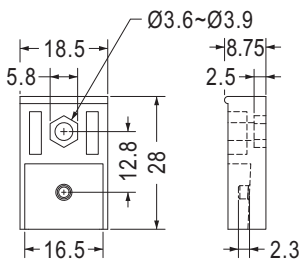

Part No.	Package
TC-48	250

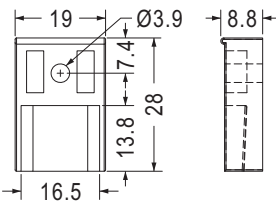

Part No.	Package
TC-68	1000

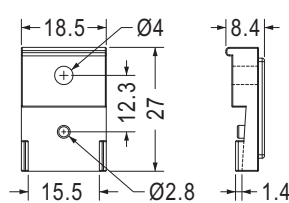

Part No.	Package
TC-73	500

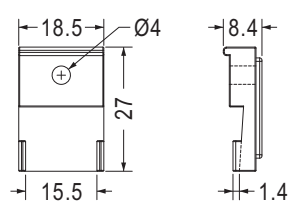

Part No.	Package
TC-74	500

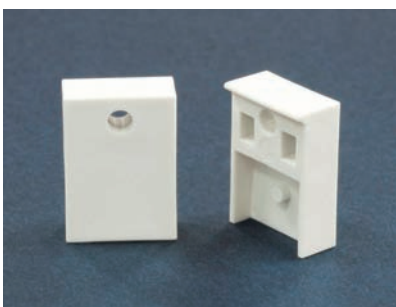

- Material: PBT (UL)
- Flame Class: 94V-0
- Color: Natural
- Unit: mm

用途：用於TO-247功率晶體，鎖於散熱片上之晶體外殼，絕緣性特佳，防止高壓跳火，耐高溫，提高可靠度增進美觀。

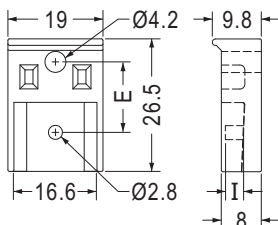

Part No.	E	I	Package
TC-60	14.1	1.8	200
TC-67	14.1	3.3	
TC-72	16.5	3.3	

# 電晶體蓋 TRANSISTOR COVER

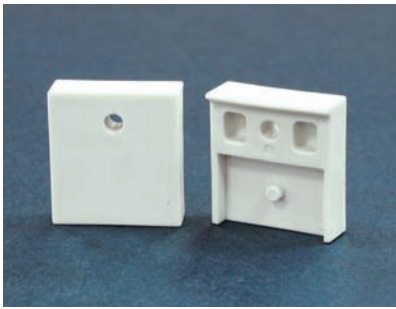

- Material: PBT (UL)
- Flame Class: 94V-0
- Color: Natural
- Unit: mm

用途：用於TO-264功率晶體，鎖於散熱片上之晶體外殼，絕緣性特佳，防止高壓跳火，耐高溫，提高可靠度增進美觀。

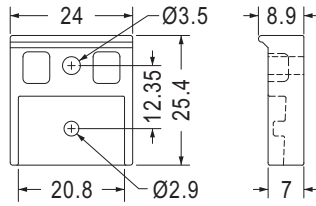

Part No.	Package
TC-61	200

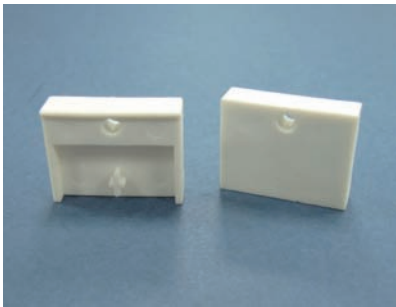

- Material: PBT (UL)
- Flame Class: 94V-0
- Color: Natural
- Unit: mm

用途：用於整流器電晶體，鎖於散熱片上之晶體外殼，絕緣性特佳，防止高壓跳火，耐高溫，提高可靠度增進美觀。

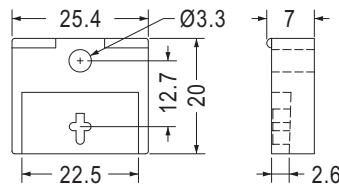

Part No.	Package
TC-8	500

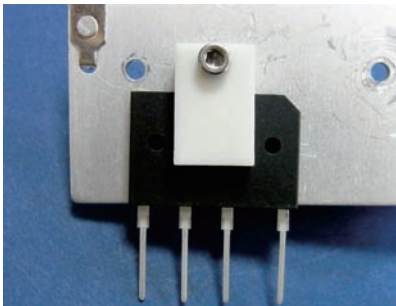

- Material: PBT (UL)
- Flame Class: 94V-0
- Color: Natural
- Unit: mm

用途：鎖於散熱片上之晶體外殼，絕緣性特佳，防止高壓跳火，耐高溫，提高可靠度增進美觀。

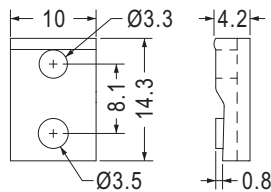

Part No.	Package
TC-13	500

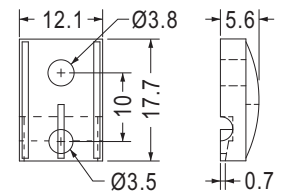

Part No.	Package
TC-20	500

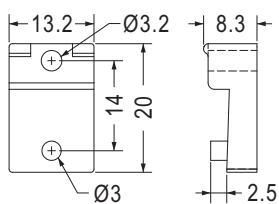

Part No.	Package
TC-35	500

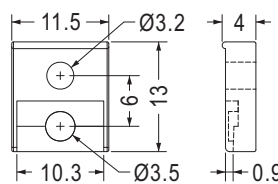

Part No.	Package
TC-38	500

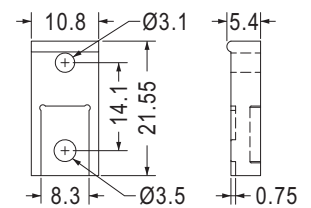

Part No.	Package
TC-40	500

# 電晶體蓋 TRANSISTOR COVER

用途：鎖於散熱片上之晶體外殼，絕緣性特佳，防止高壓跳火，耐高溫，提高可靠度增進美觀。

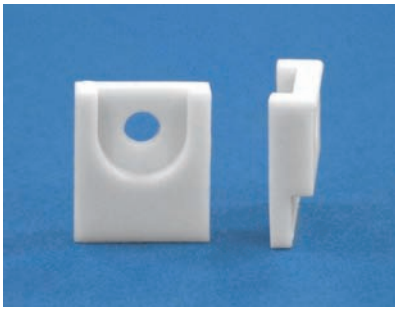

- Material: PBT (UL)/Nylon 66 (UL)
- Flame Class: 94V-2/94V-0
- Color: Natural
- Unit: mm

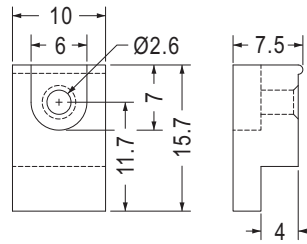

Part No.	Package
TC-39	1000

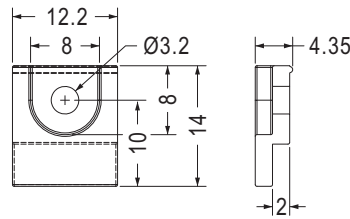

Part No.	Package
TC-41	1000

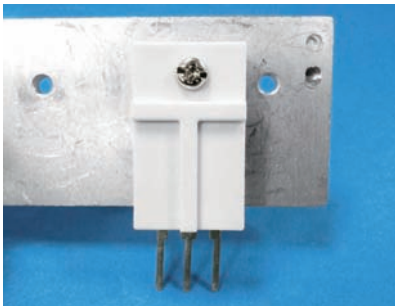

- Material: PBT (UL)
- Flame Class: 94V-0
- Color: Natural
- Unit: mm

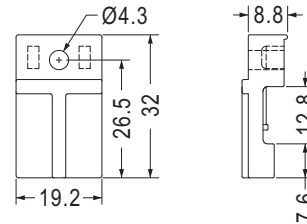

Part No.	Package
TC-52	200

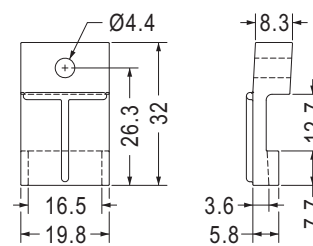

Part No.	Package
TC-79	1000

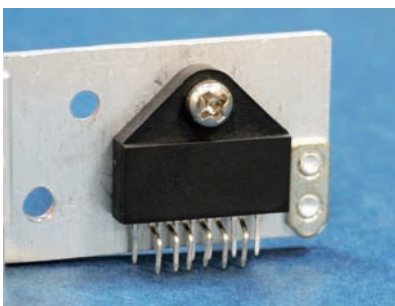

- Material: PBT (UL)
- Flame Class: 94V-0
- Color: Black
- Unit: mm

用途：鎖於散熱片上之功率IC外殼，絕緣性特佳，防止高壓跳火，耐高溫，提高可靠度增進美觀。

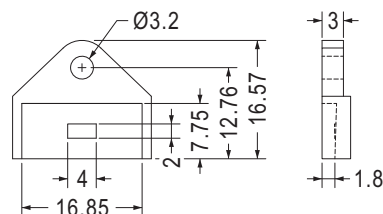

Part No.	Package
TC-62	1000

## 橋式整流蓋 BRIDGE RECTIFIER COVER

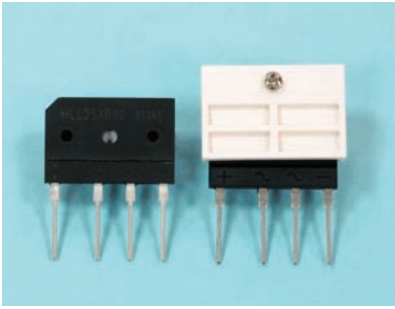

- Material: PBT (UL)
- Flame Class: 94V-0
- Color: Natural
- Unit: mm

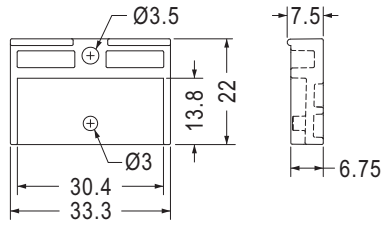

Part No.	Package
TC-59	500

用途：鎖於散熱片上之橋式整流器外殼，絕緣性特佳，防止高壓跳火耐高溫，提高可靠度，增進美觀。

## 功率IC蓋 POWER IC COVER

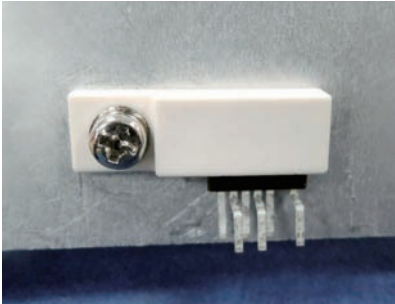

- Material: Nylon 66 (UL)/PBT (UL)
- Flame Class: 94V-2/94V-0
- Color: Natural
- Unit: mm

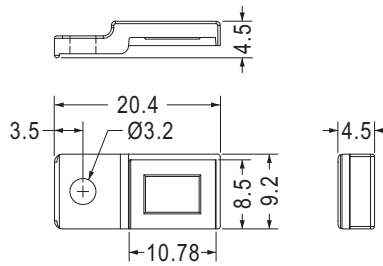

Part No.	Package
TC-26	1000

用途：鎖於散熱片上之功率IC外殼絕緣性特佳，防止高壓跳火耐高溫，提高可靠度，增進美觀。

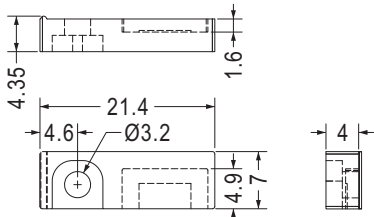

Part No.	Package
TC-31	1000

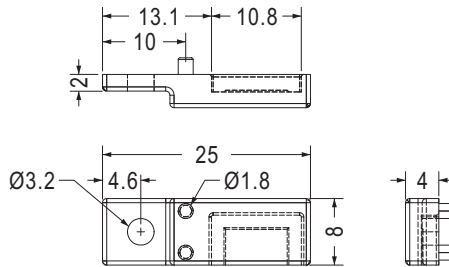

MOUNTING HOLE

Part No.	Package
PH-44	1000

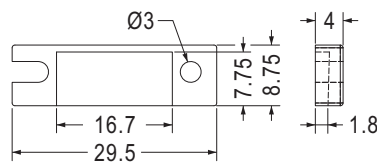
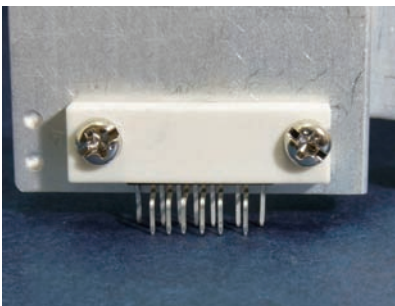
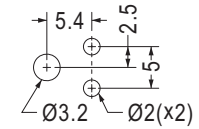

MOUNTING HOLE  
M3x0.5P

Part No.	Package
TC-42	1000

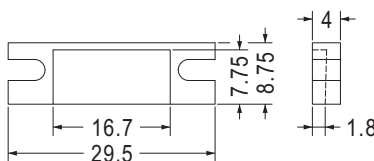

MOUNTING HOLE  
M3x0.5P OR Ø3.2

Part No.	Package
TC-47	1000

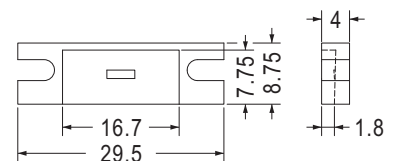

MOUNTING HOLE  
M3x0.5P OR Ø3.2

Part No.	Package
TC-63	1000

## 功率IC蓋 POWER IC COVER

用途：鎖於散熱片上之功率IC外殼絕緣性特佳，防止高壓跳火耐高溫，提高可靠度，增進美觀。

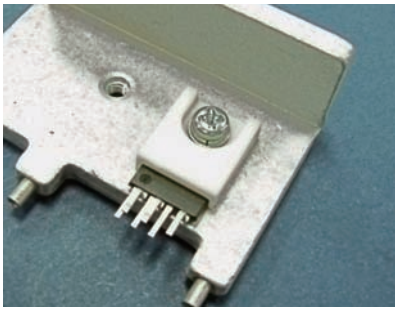

- Material: Nylon 66 (UL)/PBT (UL)
- Flame Class: 94V-2/94V-0
- Color: Natural
- Unit: mm

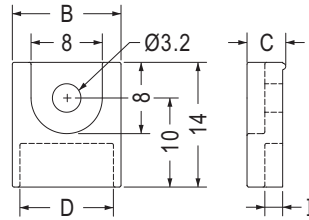

【 TC-24, TC-30 】

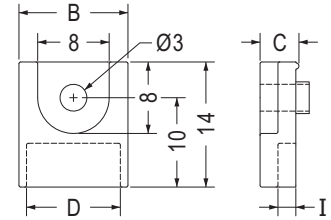

【 TC-25 】

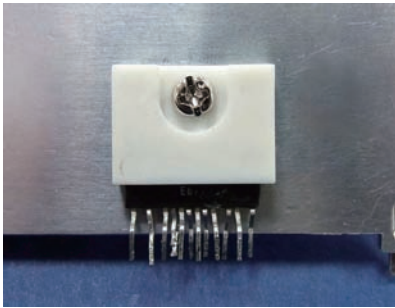

Part No.	B	C	D	I	Package
TC-24	12.2	4.4	10.5	2.0	500
TC-25	12.2	4.35	10.5	2.0	1000
TC-30	19.0	4.35	17.0	1.6	

6

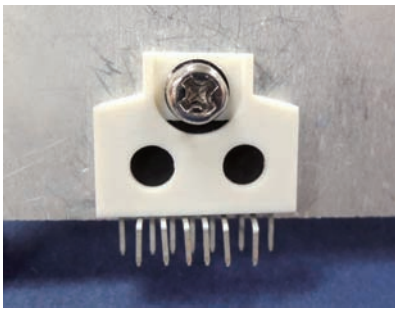

- Material: PBT (UL)
- Flame Class: 94V-0
- Color: Natural
- Unit: mm

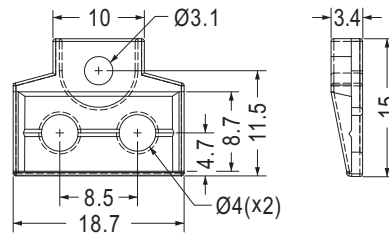

Part No.	Package
TC-54	1000

## 電晶體蓋 TRANSISTOR COVER

用途：用於功率晶體之外殼絕緣。



- Material: PBT (UL)
- Flame Class: 94V-0
- Color: Natural
- Unit: mm

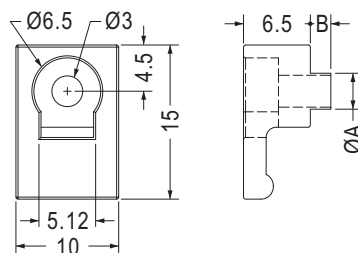

Part No.	A	B	Package
TC-28-1	3.6	1.0	1000
TC-28-2	3.6	2.0	
TC-78	3.5	1.65	

# 電晶體座 TRANSISTOR COVER

用途：鎖於散熱片上之功率IC外殼絕緣性特佳，防止高壓跳火耐高溫，提高可靠度，增進美觀。

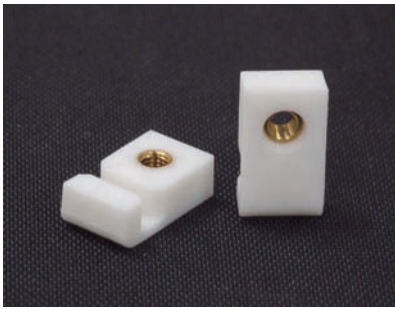

- Material: Nylon 66 (UL)
- Flame Class: 94V-2/94V-0
- Color: Natural
- Unit: mm

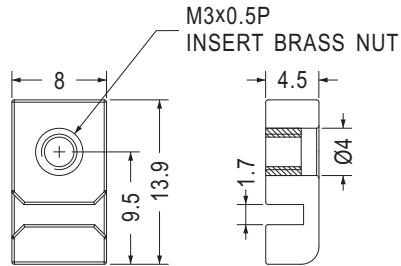

Part No.	Package
TC-65	1000



- Body Material: Nylon 66 (UL)/PPS (UL)
  - Flame Class: 94V-2/94V-0
  - Clip Material: SUS
  - Color: Black
  - Unit: mm
- 用途：鎖於散熱片之晶體外殼，絕緣性特性，防止高壓跳火耐高溫，提高可靠度，增進美觀。

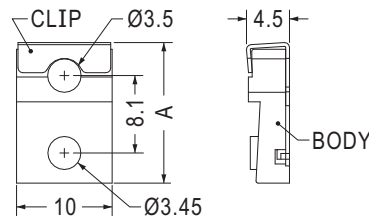

Part No.	A	Package
TCSE-1	14.5	1000
TCSE-7	14.7	



- Body Material: PPS (UL)
  - Flame Class: 94V-0
  - Clip Material: SUS
  - Color: Black
  - Unit: mm
- 用途：用於TO-220功率晶體，鎖於散熱片上之晶體外殼，絕緣性特佳，防止高壓跳火，耐高溫，提高可靠度，增進美觀。

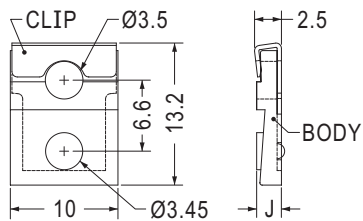

Part No.	J	Package
TCSE-2F	2.1	1000
TCSE-3F	2.2	



- Material: Nylon 66 (UL)
  - Flame Class: 94V-2/94V-0
  - Clip Material: Nickel Plated Steel
  - Color: Black
  - Unit: mm
- 用途：用於TO-3P功率晶體，保護晶體立於PC板上，使接腳不彎曲、折斷、短路，且高度一致。

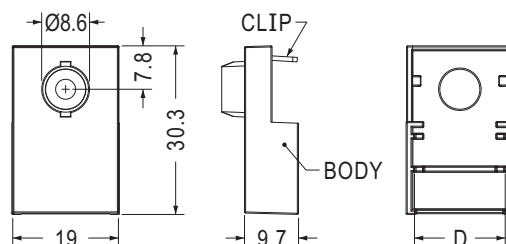

Part No.	D	Package
TCSE-8F	15.8	1000
TCSE-8SF	15.5	

## 壓板 DEPRESSOR

用途：用於壓著電子零件或功率晶體。

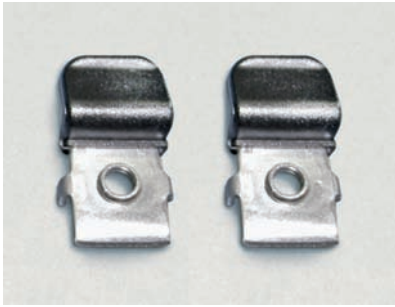

- Material: Nylon 66 (UL) 94V-2
- Metal Material: SUS
- Color: Black
- Unit: mm

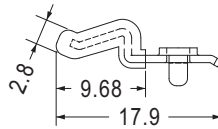
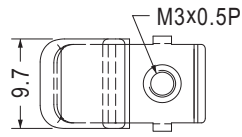

Part No.	Package
TRK-17AF	1000

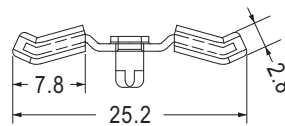
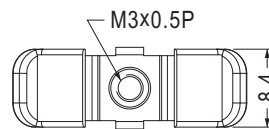

Part No.	Package
TRK-16F	1000

6

## 功率晶體壓板 POWER TRANSISTOR CLAMP DEPRESSOR

用途：可將功率晶體快速固定於散熱片上，方便、耐高壓。



- Material: Nylon 66 (UL)
- Flame Class: 94V-2/94V-0
- Color: Black
- Unit: mm

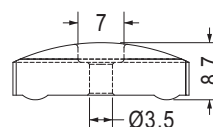
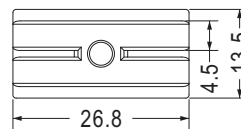

Part No.	Package
TRK-35	500

# 功率晶體壓板 POWER TRANSISTOR CLAMP DEPRESSOR

用途：可將功率晶體快速固定於散熱片上，方便、耐高壓。



- Material: PBT (UL)
- Metal Material: Steel Zinc Plated
- Flame Class: 94V-0
- Color: Black
- Unit: mm

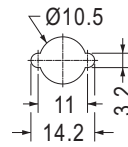
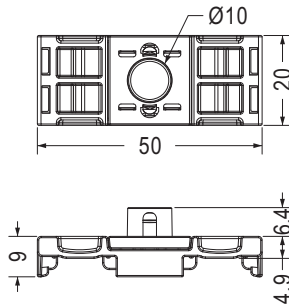

RECOMMEND MOUNTING HOLE

• Patented (專利品)

Part No.	Package
TCSF-2F	75

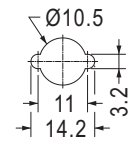
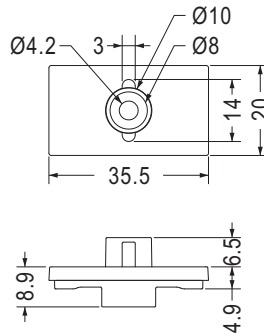

RECOMMEND MOUNTING HOLE

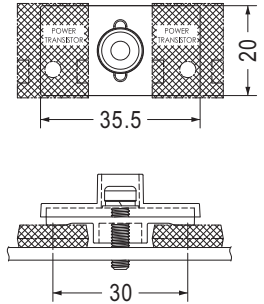

Part No.	Package
TCSF-3F	100



- Material: Nylon 66 (UL)
- Metal Material: Steel Zinc Plated
- Flame Class: 94V-0
- Color: Black
- Unit: mm

RECOMMEND ASSEMBLY DIAGRAM

POWER TRANSISTOR CLAMP DEPRESSOR

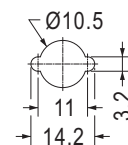
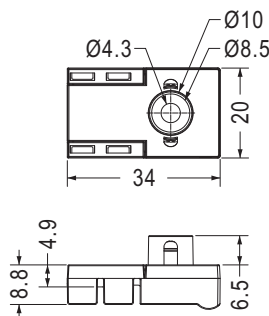
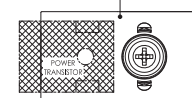

MOUNTING HOLE THICKNESS 3.0

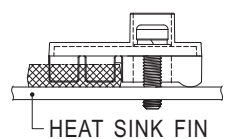

Part No.	Package
TCSF-5F	100



使用說明  
Installation Guide

# 功率晶體壓板 POWER TRANSISTOR CLAMP DEPRESSOR

用途：可將功率晶體快速固定於散熱片上，方便、耐高壓。



- Material: Zinc Plated SPCC
- Unit: mm

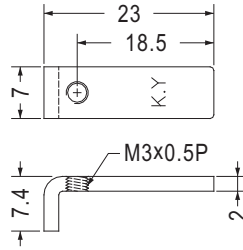

Part No.	Package
TRK-11	500

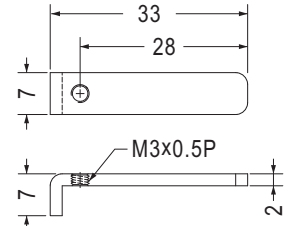

Part No.	Package
TRK-54	500

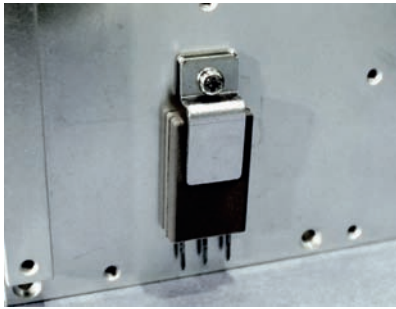

- Material: Zinc Plated Steel
- Unit: mm



Part No.	Package
TRK-1	250

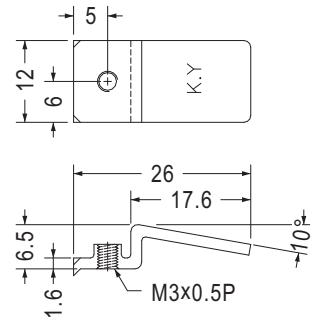

Part No.	Package
TRK-2	250



- Material: SUS
- Unit: mm

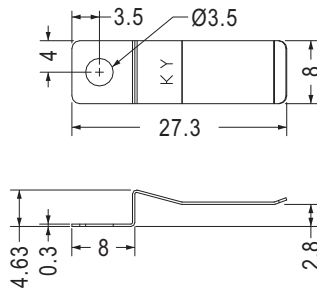

Part No.	Package
TRK-6	1000

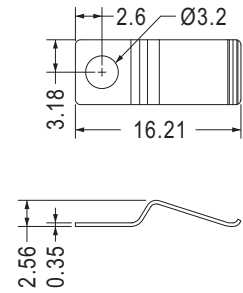

Part No.	Package
TRK-67	2000



- Material: SUS
- Unit: mm

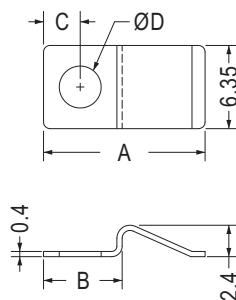

Part No.	A	B	C	D	Package
TRK-24	12.33	6.0	2.8	3.2	2000
TRK-52	12.73	6.8	3.2	3.4	

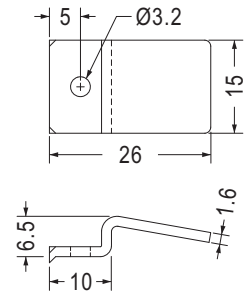

Part No.	Package
TRK-56	1000

# 功率晶體壓板 POWER TRANSISTOR CLAMP DEPRESSOR

用途：可將功率晶體快速固定於散熱片上，方便、耐高壓。

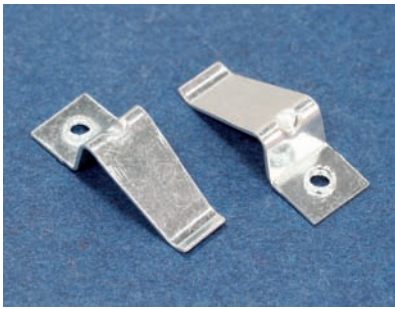

- Material: Zinc Plated Spring Stainless
- Unit: mm

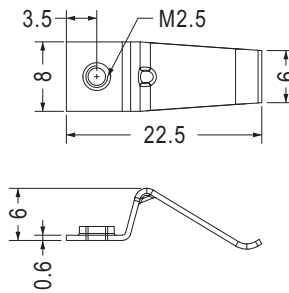

Part No.	Package
TRK-40	1000



- Material: SUS
- Unit: mm

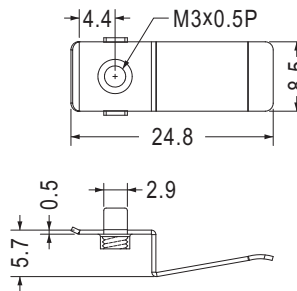

Part No.	Package
TRK-22	1000



- Material: Zinc Plated Spring Stainless
- Unit: mm

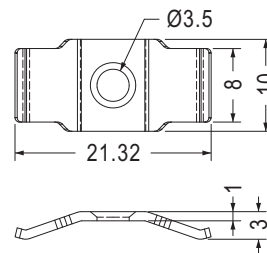

Part No.	Package
TRK-12	1000

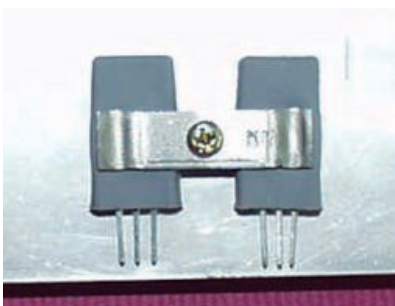

- Material: Zinc Plated Steel
- Unit: mm

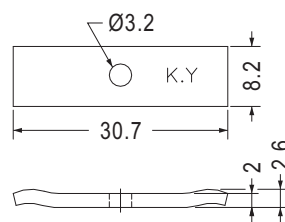

Part No.	Package
TRK-8	500

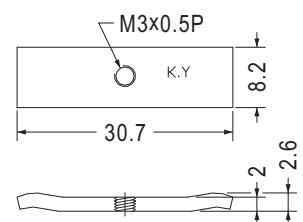

Part No.	Package
TRK-9	500

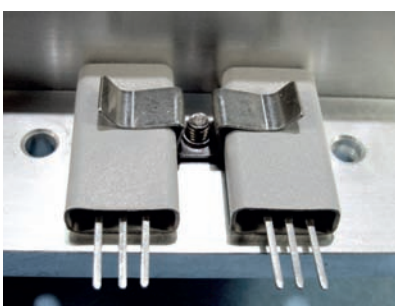

- Material: SUS
- Unit: mm

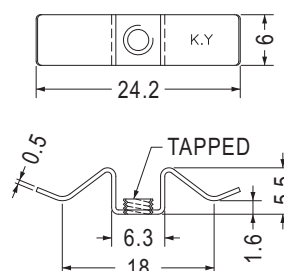

Part No.	Tapped	Package
TRK-10	M3x0.5P	1000
TRK-10(M4)	M4x0.8P	
TRK-10(632)	6-32 UNC	

# 電晶體固定彈片 TRANSISTOR CLAMP

用途：可將功率晶體快速固定於散熱片上，方便、耐高壓。

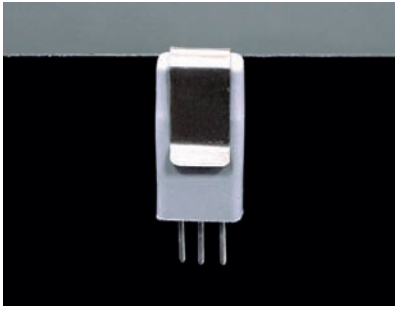

- Material: SUS
- Unit: mm

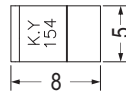
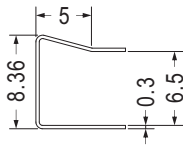

Part No.	Package
TRMC-154	1000

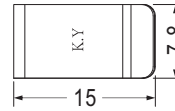

Part No.	Package
TRMC-1	1000

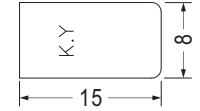
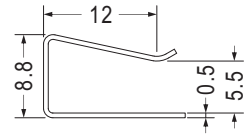

Part No.	Package
TRMC-7	1000

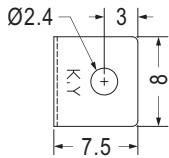
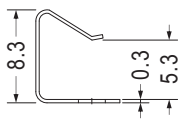

Part No.	Package
TRMC-141	1000

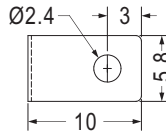
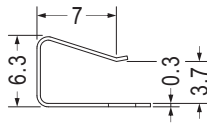

Part No.	Package
TRMC-20	1000

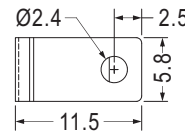
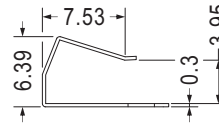

Part No.	Package
TRMC-26	1000

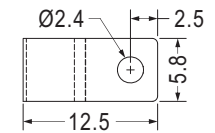
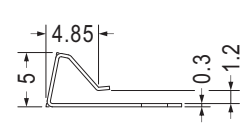

Part No.	Package
TRMC-23	1000

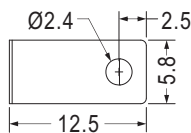
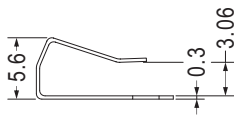

Part No.	Package
TRMC-17	1000

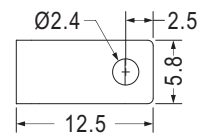
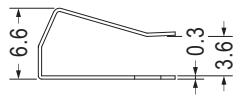

Part No.	Package
TRMC-30	1000

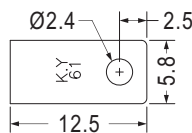
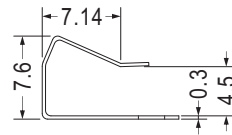

Part No.	Package
TRMC-61	1000

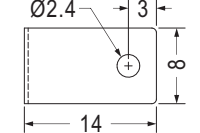
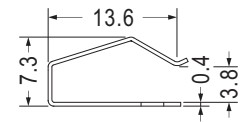

Part No.	Package
TRMC-34	1000

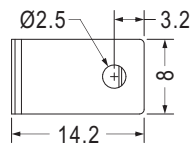
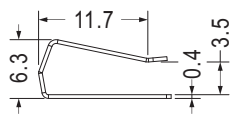

Part No.	Package
TRMC-40	1000

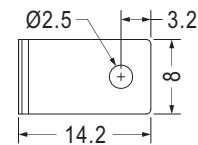
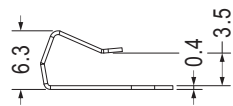

Part No.	Package
TRMC-59	1000

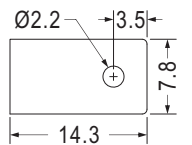
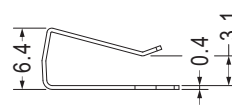

Part No.	Package
TRMC-2	1000

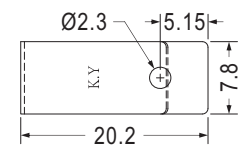
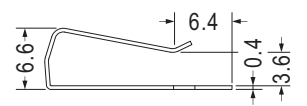

Part No.	Package
TRMC-9	1000

# 電晶體固定彈片 TRANSISTOR CLAMP

用途：可將功率晶體快速固定於散熱片上，方便、耐高壓。

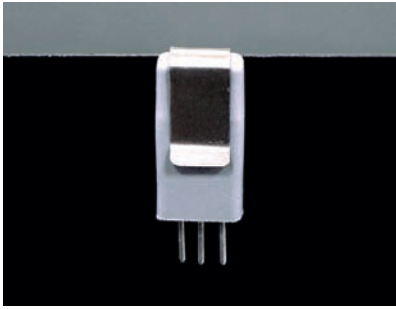

- Material: SUS
- Unit: mm

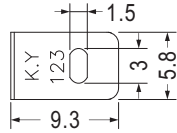
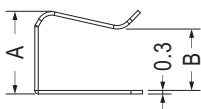

Part No.	A	B	Package
TRMC-123	7.1	5.3	1000
TRMC-124	7.22	5.35	

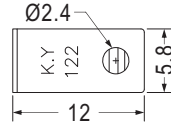
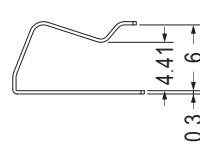

Part No.	Package
TRMC-122	1000

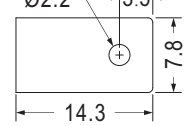
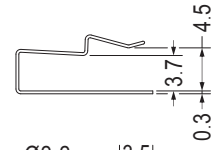

Part No.	Package
TRMC-5	1000

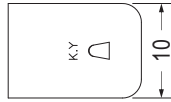
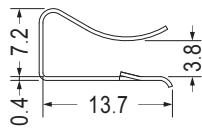

Part No.	Package
TRMC-6	1000

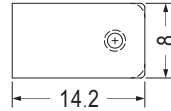
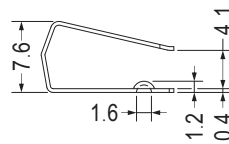

Part No.	Package
TRMC-35	1000

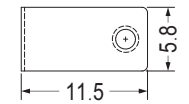
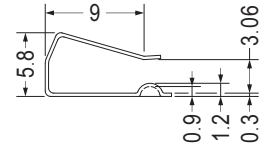

Part No.	Package
TRMC-49	1000

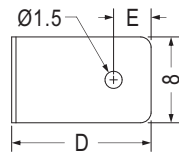
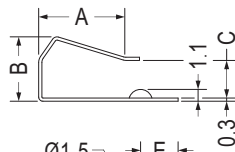
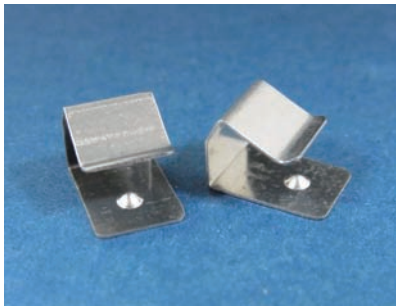

Part No.	A	B	C	D	E	Package
TRMC-76	8.0	6.1	3.5	3.5	13.0	1000
TRMC-77	6.9	7.5	4.5	4.0	11.0	
TRMC-78	6.9	8.5	5.8	4.0	11.0	

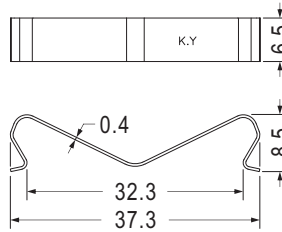
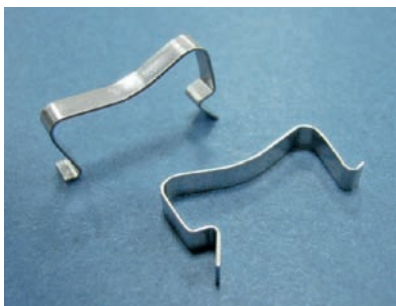

Part No.	Package
TRMC-121	1000

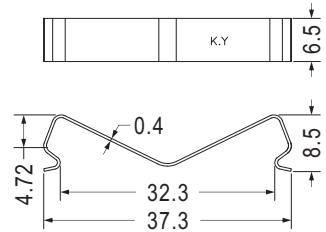

Part No.	Package
TRMC-126	1000

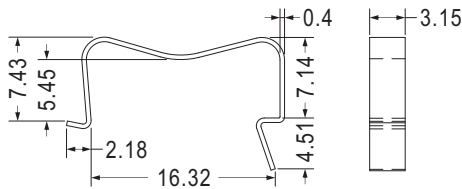

Part No.	Package
TRMC-8	1000

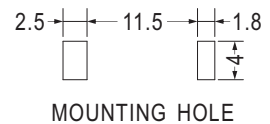
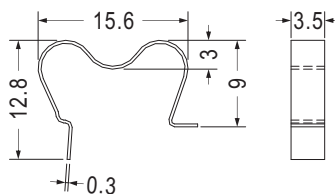

Part No.	Package
TO-220ST	2000

## 電晶體固定彈片 TRANSISTOR CLAMP

用途：可將功率晶體快速固定於散熱片上，方便。

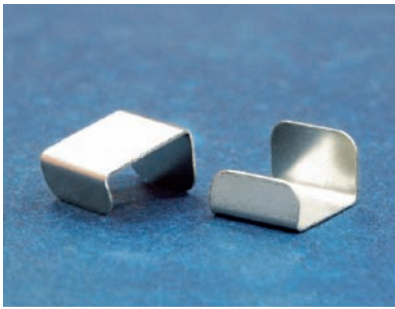

- Material: SUS
- Unit: mm

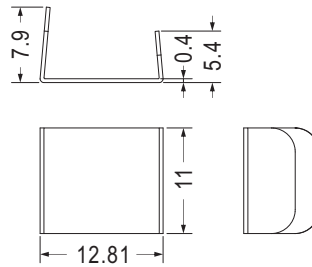

Part No.	Package
TRMC-135	1000

## 電晶體夾 TRANSISTOR CLIP

用途：用於零件之夾持。



- Material: PBT (UL)
- Flame Class: 94V-0
- Color: Natural/Black
- Unit: mm

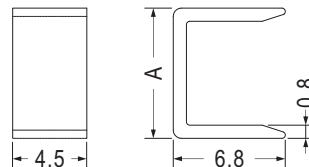

Part No.	A	Package
TRCMP-3	7.9	1000
TRCMP-4	8.6	

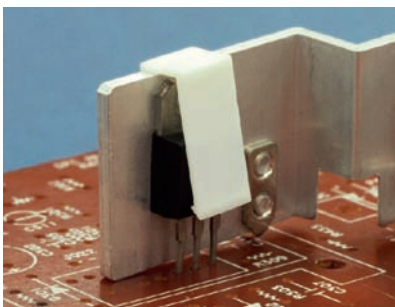

- Material: Nylon 66 (UL)/PBT (UL)
- Flame Class: 94V-0
- Color: Natural
- Unit: mm

用途：用於功率晶體及散熱片之固定，可配合灌膠使用。

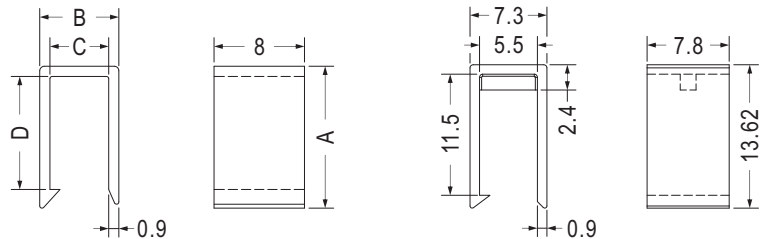

Part No.	A	B	C	D	Package
TRCMP-2	12.55	7.0	5.2	10.0	1000
TRCMP-5	12.6	7.5	5.7	10.0	
TRCMP-6	17.25	6.8	5.0	14.7	

Part No.	Package
TRCMP-1	1000

## 彈片 CLAMP

用途：做為插銷彈片。



- Material: Tin Plated Brass
- Unit: mm

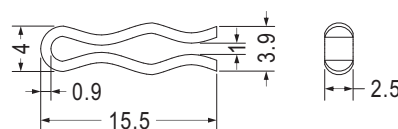

Part No.	Package
TRMC-53	1000

# 彈片 CLAMP

用途：做為彈片。



- Material: Zinc Plated Steel
- Unit: mm

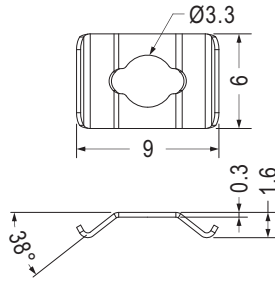

Part No.	Package
TRMC-68	1000

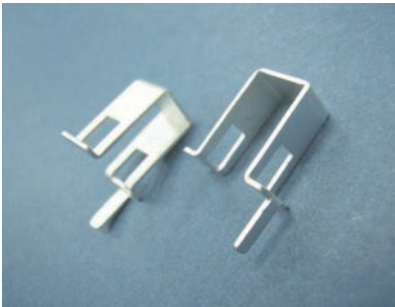

- Material: Tin Plated SPCC
- Unit: mm

用途：做為導電彈片。

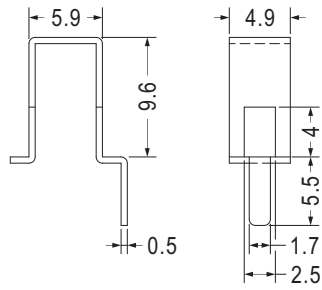

Part No.	Package
TRMC-10	1000



- Material: Tin Plated Phosphor Bronze
- Unit: mm

用途：做為彈片。

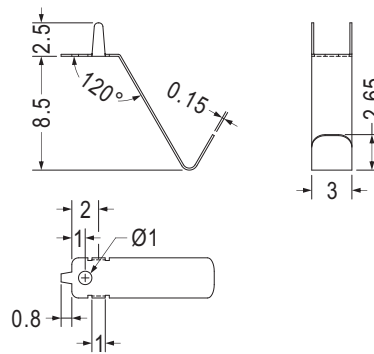

Part No.	Package
TRMC-11	2000

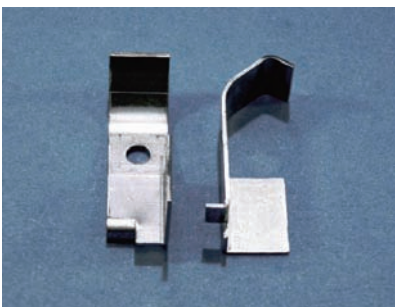

- Material: SUS
- Unit: mm

用途：做為彈片使用，彈性佳。

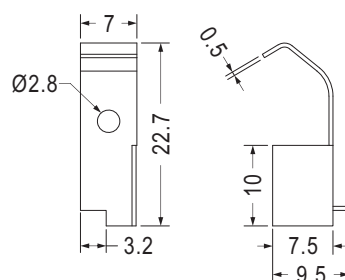

Part No.	Package
TRMC-12	1000

# 熱敏電阻座 NTC THERMISTOR SENSOR HOUSING

用途：用於熱敏電阻接腳之固定與保護。

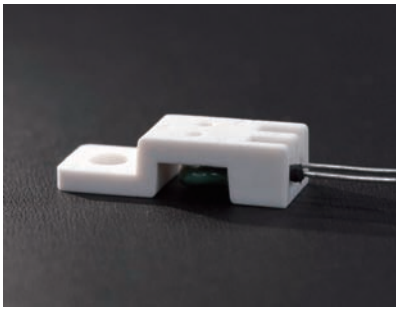

- Material: PBT (UL)
- Flame Class: 94V-0
- Color: Natural
- Unit: mm

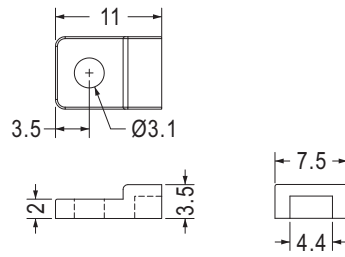

Part No.	Package
PH-49	1000

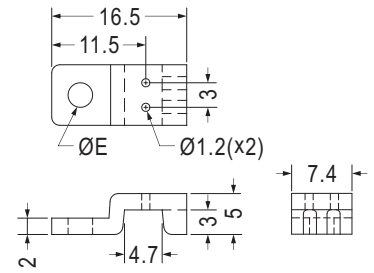

Part No.	E	Package
PH-1	3.2	1000
PH-47	5.15	

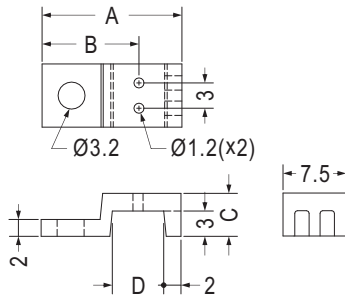

Part No.	A	B	C	D	Package
PH-1A	16.6	11.5	5.1	6.1	1000
PH-11	17.15	11.8	4.6	6.7	

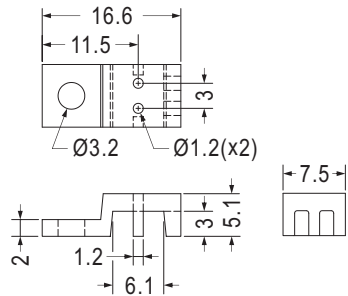

Part No.	Package
PH-24	1000

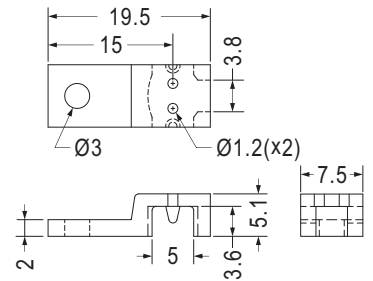

Part No.	Package
PH-7	1000

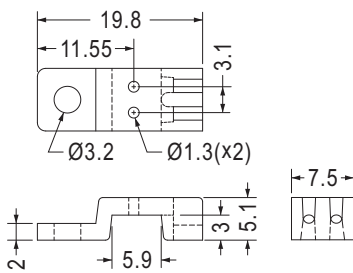

Part No.	Package
PH-5	1000

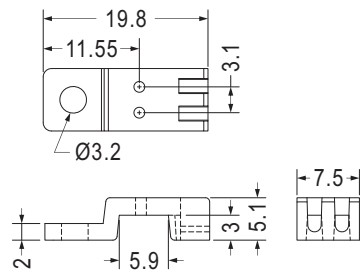

Part No.	Package
PH-53	1000

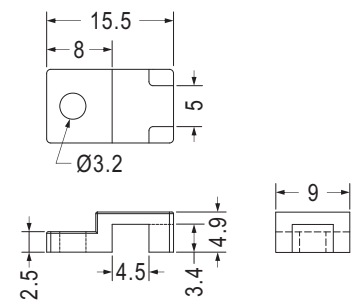

Part No.	Package
PH-14	1000

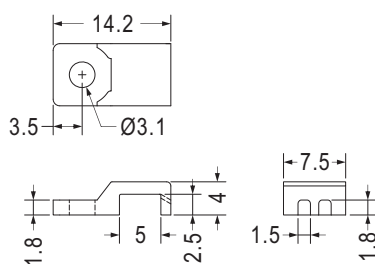

Part No.	Package
PH-46	1000

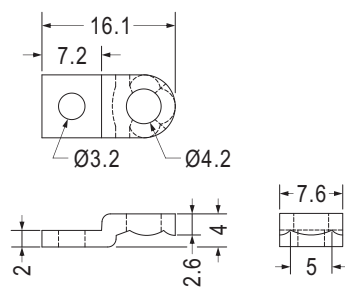

Part No.	Package
PH-3	1000

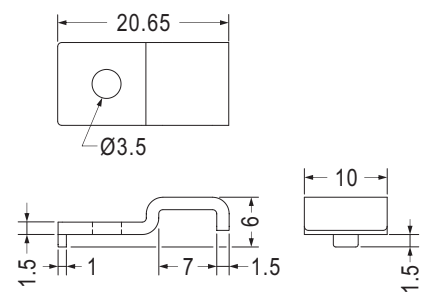

Part No.	Package
PH-12	1000

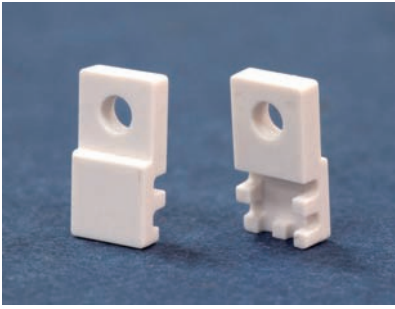

- Material: PBT (UL)
- Flame Class: 94V-0
- Color: Natural
- Unit: mm

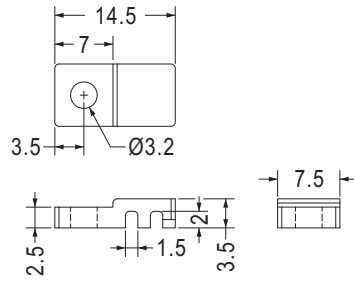

Part No.	Package
PH-50	1000

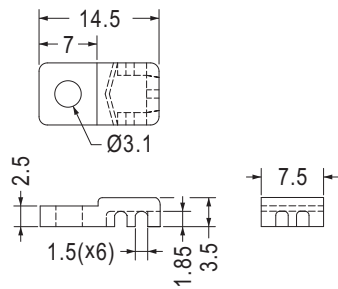

Part No.	Package
PH-2	1000

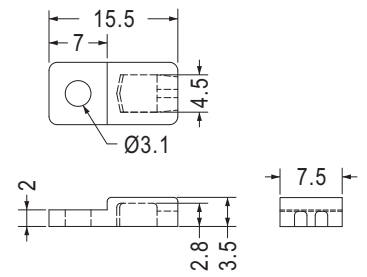

Part No.	Package
PH-2A	1000

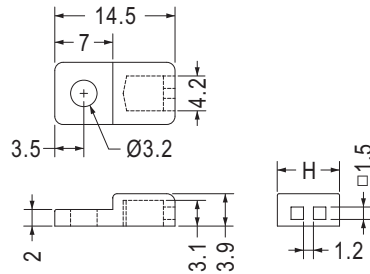

Part No.	H	Package
PH-16	7.5	1000
PH-18	6.3	

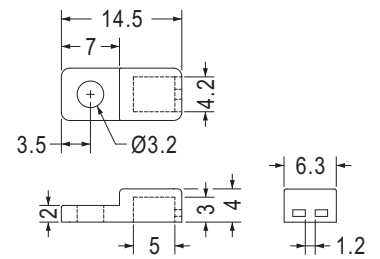

Part No.	Package
PH-20	1000

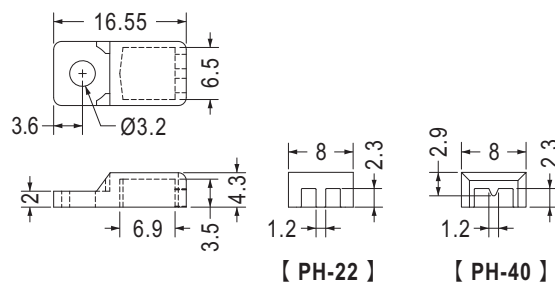

Part No.	Package
PH-22	1000
PH-40	

# 熱敏電阻座 NTC THERMISTOR SENSOR HOUSING

用途：用於熱敏電阻接腳之固定與保護。



- Material: Nylon 66 (UL)/PBT (UL)
- Flame Class: 94V-2/94V-0
- Color: Natural/Black
- Unit: mm

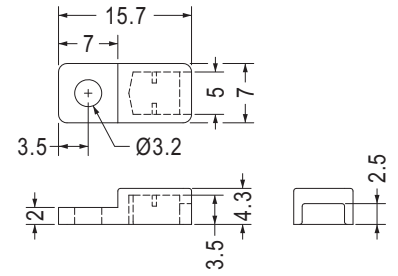
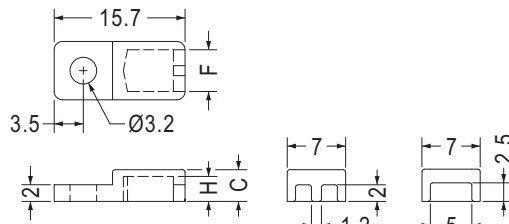

【 PH-27 】

Part No.	C	F	H	Package
PH-23	3.8	5.0	3.0	1000
PH-23L	3.8	5.4	3.4	
PH-27	4.3	5.0	3.5	

Part No.	Package
PH-31	1000



- Material: PC (UL)
- Flame Class: 94V-0
- Color: Black
- Unit: mm

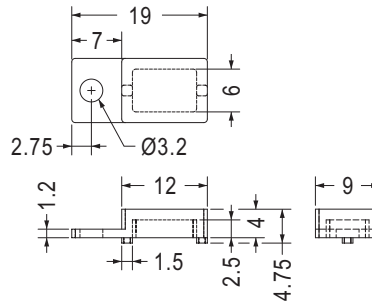

Part No.	Package
PH-30	1000

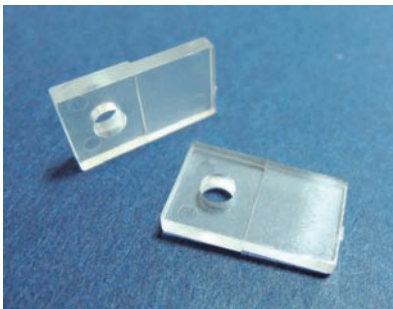

- Material: PC (UL)
- Flame Class: 94V-2/94V-0
- Color: Natural/Transparent
- Unit: mm

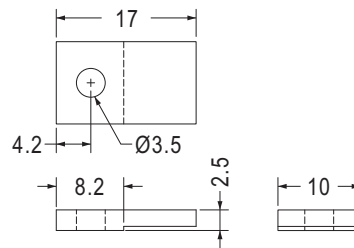

Part No.	Package
PH-13	1000



- Material: Nylon 66 (UL)
- Flame Class: 94V-2/94V-0
- Color: Natural/Black
- Unit: mm

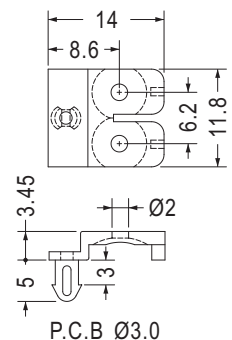
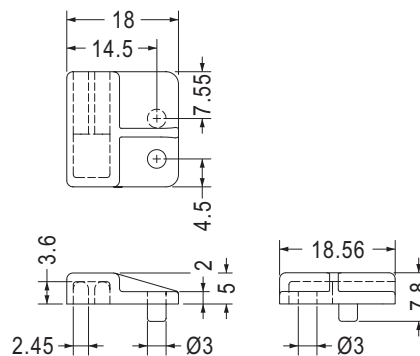

Part No.	Package
PH-21	200

Part No.	Package
PHK-1	1000

# 熱敏電阻座 NTC THERMISTOR SENSOR HOUSING

用途：用於熱敏電阻接腳之固定與保護。

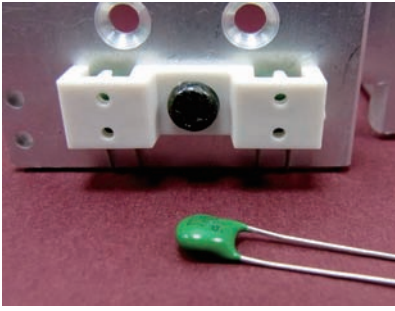

- Material: PC (UL)
- Flame Class: 94V-0
- Color: Natural
- Unit: mm

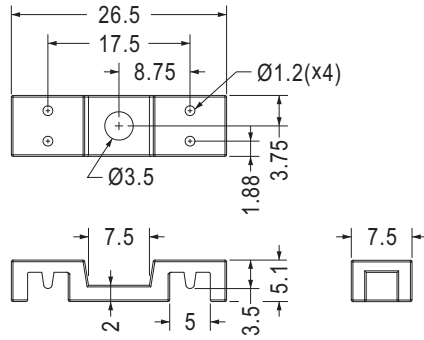

Part No.	Package
PH-37	1000



- Material: Nylon 66 (UL)
- Flame Class: 94V-2/94V-0
- Color: Natural/Black
- Unit: mm

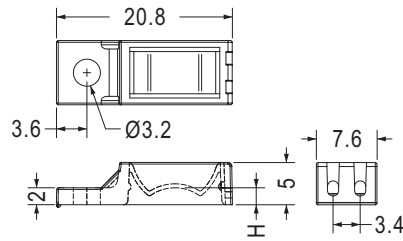

Part No.	H	Package
PHG-2	2.0	1000
PHG-3	0.71	

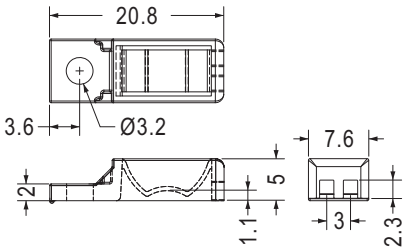

Part No.	Package
PHG-6	1000

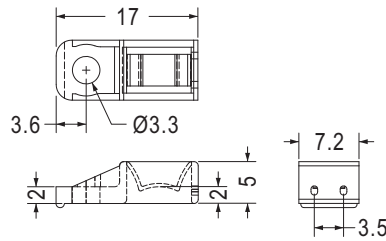

Part No.	Package
PHG-4	1000

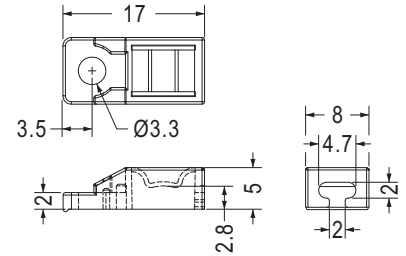

Part No.	Package
PHG-11	1000

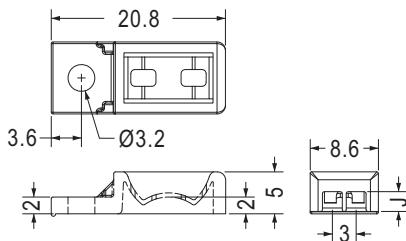

Part No.	J	Package
PHG-8	1.2	1000
PHG-10	2.5	

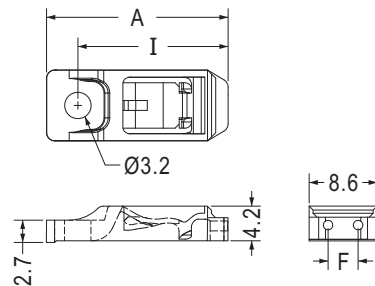

Part No.	A	F	I	Package
PHG-12	22.0	3.8	18.2	1000
PHG-14	21.5	3.5	17.7	

# 熱敏電阻座 NTC THERMISTOR SENSOR HOUSING

用途：用於熱敏電阻接腳之固定與保護。

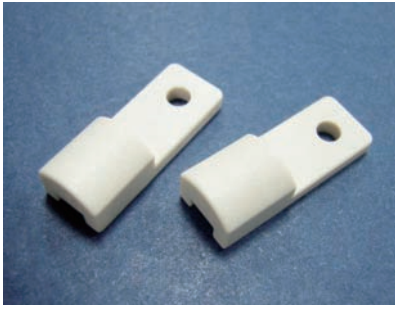

- Material: PBT (UL)
- Flame Class: 94V-0
- Color: Natural
- Unit: mm

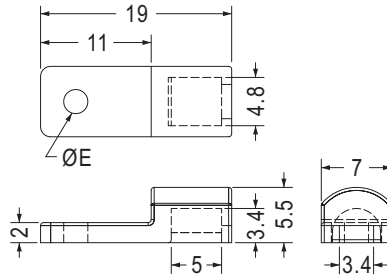

Part No.	E	Package
PH-28	2.4	1000
PH-48	3.2	

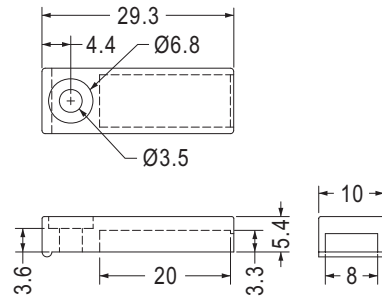
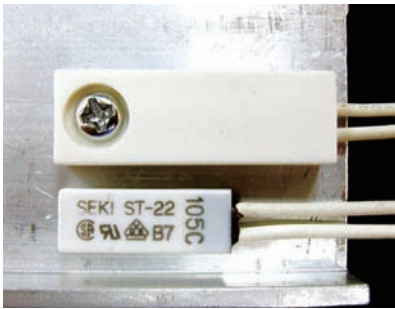

Part No.	Package
PH-15	1000

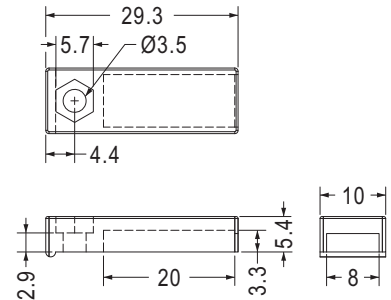

Part No.	Package
PH-43	1000

6



- Material: Nylon 66 (UL)
- Flame Class: 94V-2/94V-0
- Color: Natural/Black
- Unit: mm

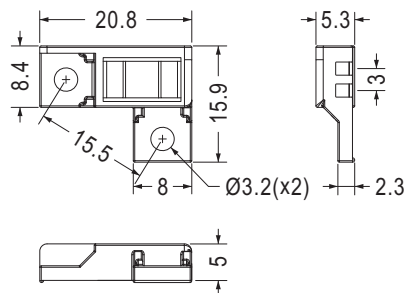

Part No.	Package
PHG-7	1000

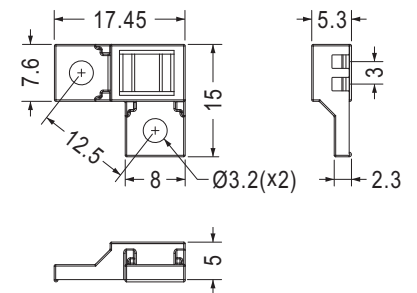

Part No.	Package
PHG-15	1000

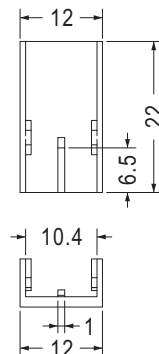

Part No.	Package
PH-34	1000

## 熱敏電阻座 THERMISTOR HOLDER

用途：用於熱敏電阻之固定。



- Material: Nickel Plated Brass
- Unit: mm

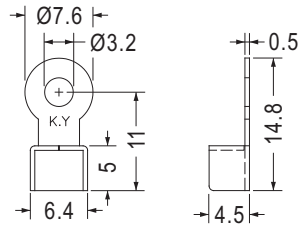

Part No.	Package
GND-27	1000

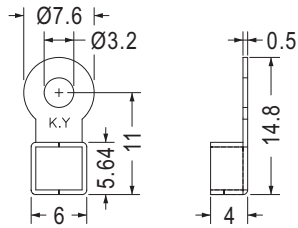

Part No.	Package
GND-48	1000

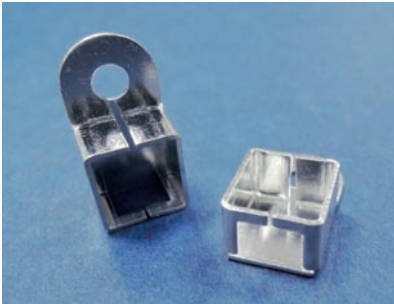

- Material: Bright Tin Plated Brass
- Unit: mm

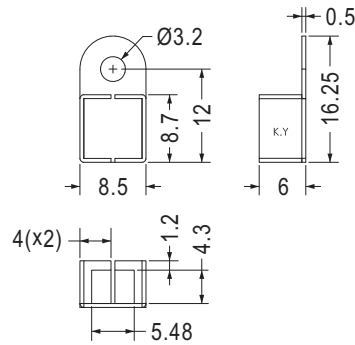

Part No.	Package
GND-75	1000

## 電晶體墊片 TRANSISTOR WASHER

用途：用於功率晶體之固定。



- Material: PBT (UL)
- Flame Class: 94V-0
- Color: Natural
- Unit: mm

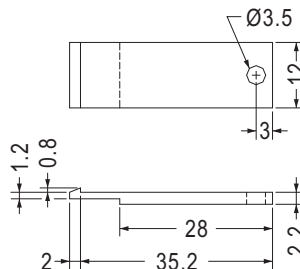

Part No.	Package
TCP-1	1000

# 電晶體墊片 TRANSISTOR WASHER

用途：鎖於電晶體上，避免晶體外殼與散熱片間造成短路。



- Material: PBT/PC V-2/PC V-0/POM/PPS/N46 V-0/N6 V-2/N66 V-2/N66 V-0
- Color: Natural/Black
- Unit: mm

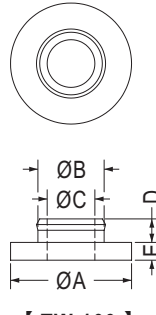
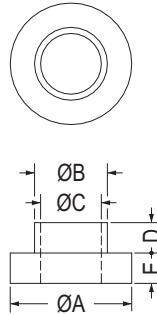

【 TW-109 】

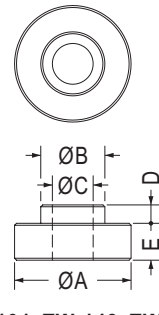

【 TW-131, TW-148, TW-179 】

Part No.	A	B	C	D	E	Package
TW-1	6.0	3.6	3.0	1.5	1.5	2000
TW-2	6.2	3.5	3.0	3.0	1.5	
TW-3	6.2	3.55	3.0	2.5	2.0	
TW-4	6.0	3.5	3.0	2.0	2.0	
TW-5	6.2	3.5	3.0	1.2	1.0	
TW-6	6.2	3.5	3.0	1.4	1.2	
TW-7	8.0	3.8	3.1	2.8	1.2	
TW-8	8.0	3.8	3.1	1.2	1.2	
TW-9	10.0	6.0	5.0	5.0	1.0	
TW-10	10.0	5.0	4.0	4.0	1.0	
TW-11	9.5	6.3	4.5	1.2	1.2	1000
TW-12	9.5	6.3	4.1	0.8	1.7	
TW-14	9.9	8.3	6.5	1.5	1.0	
TW-15	6.2	3.6	3.0	2.4	1.9	
TW-16	6.1	3.5	3.0	1.6	1.4	2000
TW-17	6.1	3.55	3.0	1.5	2.0	
TW-18	6.35	5.15	3.5	1.6	0.6	
TW-20	6.5	3.5	3.0	4.0	0.9	
TW-21	7.0	5.0	3.0	5.8	2.0	
TW-22	11.9	7.9	4.0	3.0	2.6	
TW-23	7.1	5.0	3.0	2.3	2.0	
TW-24	6.4	3.55	2.95	2.0	1.3	
TW-25	7.92	4.83	3.05	0.8	1.14	
TW-26	6.0	3.6	3.0	5.2	1.0	
TW-27	6.0	3.55	2.95	1.4	1.4	
TW-29	14.0	7.5	6.0	1.8	1.2	
TW-30	14.0	9.8	6.6	1.7	0.9	
TW-31	16.0	11.4	10.0	0.8	0.7	
TW-33	6.0	3.5	2.5	7.2	5.0	
TW-34	6.0	3.5	2.5	11.0	5.0	
TW-35	6.0	3.55	2.95	1.2	1.3	
TW-36	15.7	9.7	4.5	6.5	5.0	1000
TW-37	6.0	3.55	2.95	3.2	2.0	2000
TW-38	6.1	3.5	2.95	1.5	1.1	
TW-39	5.46	3.43	2.95	0.81	1.02	
TW-41	6.6	4.95	2.6	6.0	1.5	
TW-42	6.35	4.78	3.94	1.57	3.18	1000
TW-43	25.4	11.0	8.3	2.29	1.58	
TW-48	11.0	8.0	5.5	8.0	1.3	2000
TW-49	6.4	3.53	3.0	2.0	1.2	
TW-53	11.8	6.0	4.0	1.9	0.5	
TW-57	10.0	4.3	3.45	3.0	1.0	
TW-58	6.2	3.5	3.0	2.5	2.7	

Part No.	A	B	C	D	E	Package
TW-59	6.2	3.5	3.0	2.5	2.0	2000
TW-60	6.4	3.5	3.0	2.0	1.3	
TW-61	6.0	3.5	3.0	3.2	2.0	
TW-62	6.1	3.5	3.0	1.5	1.1	
TW-63	10.0	5.0	3.95	4.0	0.5	
TW-64	4.0	2.7	2.1	0.8	0.8	
TW-65	6.0	3.55	3.0	4.6	2.0	
TW-70	6.2	3.6	2.95	2.9	1.9	
TW-73	9.0	6.0	4.5	8.0	2.0	
TW-75	7.0	4.4	3.2	7.5	0.5	
TW-77	5.0	4.1	2.2	1.2	1.2	
TW-78	21.0	17.4	16.2	2.8	0.8	
TW-79	6.0	3.6	2.95	2.4	1.2	
TW-80	6.0	3.6	2.95	4.8	1.2	
TW-84	6.2	3.6	2.95	12.0	1.9	
TW-85	6.1	3.5	2.9	1.85	1.4	
TW-88	6.0	3.5	3.0	2.3	1.8	
TW-90	6.3	3.5	3.0	2.6	1.2	
TW-97	9.0	3.5	3.0	3.5	1.0	
TW-99	6.0	3.8	3.1	6.5	1.2	
TW-100	6.1	3.5	3.0	2.1	1.4	
TW-101	6.1	3.5	3.0	2.7	1.4	
TW-102	12.7	6.7	4.3	1.5	1.46	
TW-104	15.0	7.9	6.2	4.0	1.5	
TW-106	9.5	6.5	5.1	10.7	1.5	
TW-107	6.2	3.5	3.0	2.9	1.9	
TW-108	6.4	3.5	3.0	2.0	1.2	
TW-109	17.0	9.3	6.7	3.3	2.5	
TW-110	9.5	6.0	3.7	1.5	1.0	
TW-111	6.0	3.4	2.7	2.5	1.0	
TW-113	6.0	3.55	3.0	1.6	1.3	
TW-115	6.3	3.5	3.0	2.6	2.0	
TW-123	8.2	4.65	4.05	3.6	0.5	
TW-127	6.2	3.5	3.0	4.1	2.0	
TW-131	12.0	6.6	4.2	1.9	3.8	
TW-135	13.0	7.9	6.6	2.4	1.7	
TW-136	6.2	3.55	3.0	0.6	1.2	
TW-143	6.3	3.9	3.2	1.5	2.5	
TW-145	12.0	8.0	3.0	3.0	1.4	
TW-146	14.0	8.1	3.1	1.8	2.5	
TW-148	7.6	3.9	3.1	4.0	2.0	
TW-149	6.2	4.1	3.2	2.0	1.0	1000
TW-150	7.6	3.5	3.1	4.0	2.0	2000

# 電晶體墊片 TRANSISTOR WASHER

用途：鎖於電晶體上，避免晶體外殼與散熱片間造成短路。



- Material: PBT/PC V-2/PC V-0/POM/PPS/N46 V-0/N6 V-2/N66 V-2/N66 V-0
- Color: Natural/Black
- Unit: mm

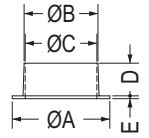
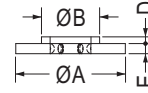
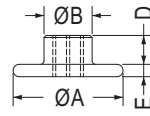
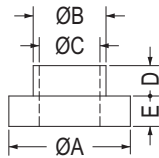
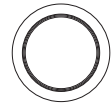
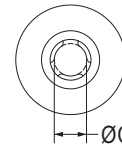
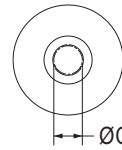
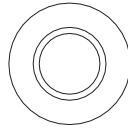

【 TW-178 】

【 TW-214 】

【 TW-240,TW-289 】

Part No.	A	B	C	D	E	Package
TW-151	6.1	3.5	3.0	2.25	2.0	2000
TW-153	6.1	3.5	3.0	0.8	2.0	
TW-156	6.0	3.5	3.0	0.9	1.3	
TW-157	6.2	3.5	3.0	4.6	2.0	
TW-159	25.0	10.0	8.2	12.0	4.5	500
TW-160	4.0	2.7	2.1	0.7	0.8	2000
TW-161	6.5	4.25	3.2	4.0	3.0	
TW-162	13.0	6.5	4.5	8.0	5.0	500
TW-163	24.0	11.2	9.0	3.0	1.1	1000
TW-165	12.0	7.6	6.1	16.5	2.0	
TW-168	6.2	3.5	3.0	2.0	1.9	2000
TW-169	14.0	8.6	7.95	5.0	2.0	
TW-171	13.0	7.9	6.6	6.4	1.7	
TW-172	10.36	6.1	5.59	4.75	1.57	
TW-173	6.0	4.2	3.2	3.5	0.6	
TW-175	10.0	6.3	4.2	10.5	7.0	
TW-176	10.0	6.3	4.2	15.5	7.0	
TW-177	11.0	8.2	5.5	15.0	2.0	
TW-178	16.0	7.0	4.15	4.2	1.8	1000
TW-179	14.0	7.6	5.2	2.0	3.0	2000
TW-182	6.0	3.8	3.2	1.1	2.9	
TW-185	6.0	3.5	2.5	5.2	3.1	
TW-186	6.0	3.5	2.5	8.6	3.1	
TW-188	15.75	10.0	6.5	19.0	3.0	500
TW-189	15.75	10.0	6.5	39.0	3.0	250
TW-192	6.2	4.3	3.1	2.0	1.0	2000
TW-194	5.0	3.6	2.95	4.8	1.2	
TW-198	8.7	5.4	4.6	6.5	2.0	
TW-199	8.1	3.6	2.95	2.5	1.3	
TW-202	4.8	3.0	2.6	3.5	1.2	
TW-203	3.0	2.0	0.9	3.5	0.5	
TW-204	6.2	3.55	2.95	8.0	2.2	
TW-207	11.0	6.2	5.0	4.9	1.0	
TW-208	11.1	6.35	5.1	6.35	7.9	
TW-209	8.0	4.25	3.2	3.0	2.0	
TW-213	6.5	5.4	5.1	2.5	1.0	
TW-214	13.0	6.0	3.85	0.8	1.2	
TW-215	9.0	6.0	4.0	6.3	2.0	
TW-219	4.6	3.0	2.3	1.6	1.2	
TW-222	3.0	1.8	0.9	1.0	0.5	
TW-223	6.0	3.1	2.6	1.5	1.0	
TW-224	20.0	11.9	6.5	2.5	3.0	1000
TW-225	11.0	8.0	5.5	8.0	3.0	

Part No.	A	B	C	D	E	Package
TW-226	4.2	3.0	2.6	1.0	2.25	2000
TW-227	23.7	13.0	10.0	13.0	2.0	500
TW-228	23.7	13.0	10.0	23.0	2.0	
TW-229	20.0	11.0	8.1	8.0	2.0	1000
TW-230	20.0	11.0	8.1	13.0	2.0	500
TW-234	8.0	4.4	3.2	0.9	2.0	2000
TW-235	13.0	7.9	6.6	1.6	1.7	
TW-237	13.0	9.8	4.5	10.3	2.0	1000
TW-240	8.0	4.65	3.7	12.0	1.0	2000
TW-242	6.1	3.55	3.0	1.5	0.9	
TW-243	10.5	9.5	8.0	0.7	1.0	
TW-245	11.5	7.5	6.7	2.0	1.0	
TW-246	15.0	7.9	4.2	2.0	1.5	
TW-249	8.5	5.75	5.2	3.0	1.2	
TW-250	8.7	5.2	4.4	0.8	1.6	
TW-252	16.0	8.0	5.0	1.55	0.85	
TW-253	22.0	16.0	10.5	4.5	1.5	1000
TW-256	8.7	5.2	4.4	4.7	1.6	2000
TW-257	12.0	9.0	6.0	6.0	2.0	
TW-258	20.0	12.0	8.0	10.0	3.0	1000
TW-259	20.0	12.0	8.0	7.0	2.0	
TW-260	10.0	7.0	5.0	10.0	1.0	2000
TW-261	20.0	10.0	8.0	3.0	3.0	1000
TW-262	20.0	12.0	10.0	2.0	3.0	
TW-263	25.0	12.0	10.0	5.0	1.0	
TW-264	18.0	16.0	12.0	9.0	1.0	
TW-266	15.0	7.9	6.2	2.0	2.0	2000
TW-268	15.0	9.9	8.2	2.0	1.5	
TW-270	20.0	10.0	8.0	12.0	3.0	1000
TW-273	15.0	8.9	6.2	3.0	1.5	2000
TW-274	16.0	12.0	10.0	4.0	2.0	
TW-275	10.0	7.0	5.0	2.0	1.0	
TW-276	26.0	16.0	14.0	5.0	5.0	
TW-278	12.0	8.0	5.0	7.0	2.0	2000
TW-279	12.0	6.0	4.0	15.0	2.0	1000
TW-282	12.0	8.0	6.0	3.0	1.0	2000
TW-283	14.0	8.0	6.0	3.0	3.0	
TW-284	16.0	12.0	10.0	3.0	1.0	
TW-287	16.0	8.0	6.0	6.0	5.0	
TW-289	27.5	20.8	20.2	9.2	0.8	1000
TW-291	12.0	7.0	5.0	6.0	2.0	2000
TW-292	5.5	3.5	3.0	2.6	0.6	
TW-301	19.0	9.4	8.2	1.7	0.8	1000

# 電晶體墊片 TRANSISTOR WASHER

用途：鎖於電晶體上，避免晶體外殼與散熱片間造成短路。



- Material: PBT/PC V-2/PC V-0/POM/PPS/N46 V-0/N6 V-2/N66 V-2/N66 V-0
- Color: Natural/Black
- Unit: mm

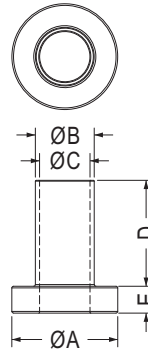
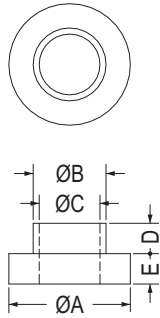

【 TW-317 】

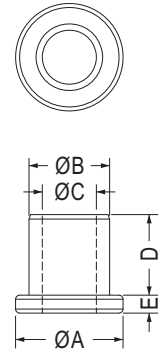

【 TW-319, TW-333, TW-354 】

Part No.	A	B	C	D	E	Package	
TW-304	7.4	4.3	3.6	1.6	1.2	2000	
TW-308	6.0	3.7	2.9	6.4	1.2		
TW-311	7.9	4.5	3.65	6.0	1.2		
TW-313	20.0	11.0	8.0	4.0	2.0	1000	
TW-317	6.3	3.5	3.0	6.3	1.6	2000	
TW-319	12.0	9.0	6.0	9.0	2.0		
TW-321	12.0	7.9	4.2	6.0	2.2		
TW-322	20.7	7.6	6.0	7.7	0.8		
TW-323	6.35	4.75	3.66	0.81	1.57		
TW-324	7.92	4.75	3.66	0.81	1.57		
TW-328	6.1	3.5	2.9	1.6	2.4		
TW-329	11.5	7.5	5.5	8.0	1.0		
TW-330	8.7	5.2	4.4	3.2	1.6		
TW-331	10.0	3.9	3.1	1.7	1.3		
TW-332	6.3	3.5	3.0	7.3	1.6		
TW-333	12.0	9.0	6.0	8.0	2.0		1000

Part No.	A	B	C	D	E	Package
TW-335	8.7	5.2	4.4	6.4	1.6	2000
TW-336	6.0	3.7	2.9	9.5	1.2	
TW-339	6.4	4.7	3.0	1.3	0.8	
TW-340	8.7	5.2	4.4	1.6	1.6	
TW-341	9.5	7.9	6.4	1.5	0.8	
TW-342	12.5	7.92	6.6	1.98	0.81	
TW-343	10.15	6.6	5.1	6.35	3.2	
TW-345	15.0	8.9	4.2	2.0	1.5	
TW-346	10.0	3.9	2.6	1.7	1.3	
TW-347	18.0	10.9	10.2	2.5	1.5	
TW-350	6.0	3.3	2.1	1.5	1.0	
TW-351	7.4	4.3	3.6	6.4	1.2	
TW-352	18.0	11.9	6.2	2.5	1.5	
TW-353	10.0	4.9	3.1	1.7	1.3	
TW-354	12.0	9.0	6.0	4.0	2.0	
★TW-359	9.9	8.3	6.6	1.0	1.5	

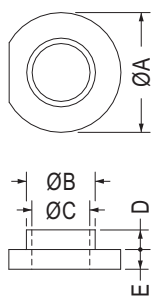

【 TW-19 】

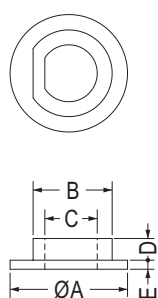

【 TW-68, TW-247, TW-320, TW-338, TW-360 】

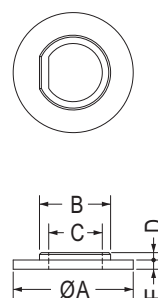

【 TW-181 】

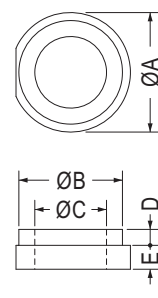

【 TW-195 】

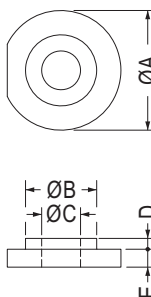

【 TW-233 】

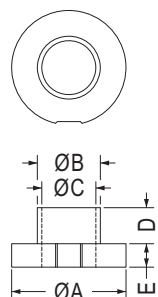

【 TW-314 】

Part No.	A	B	C	D	E	Package
TW-19	6.22	3.56	3.02	1.02	1.02	2000
TW-68	13.0	8.75	5.8	2.4	1.0	
TW-181	13.0	7.7	5.8	0.8	1.0	
TW-195	9.53	8.26	5.72	1.27	1.91	1000
TW-233	20.0	11.9	6.5	1.8	3.0	2000
TW-247	13.0	8.75	5.8	1.9	1.0	
TW-314	6.4	3.55	3.0	2.0	1.3	
TW-320	10.4	8.4	6.4	0.5	1.0	
TW-338	16.0	10.16	8.86	1.0	0.85	
★TW-360	10.4	7.9	5.9	2.0	1.0	

# 電晶體墊片 TRANSISTOR WASHER

用途：鎖於電晶體上，避免晶體外殼與散熱片間造成短路。



- Material: PBT/PC V-2/PC V-0/POM/PPS/N46 V-0/N6 V-2/N66 V-2/N66 V-0
- Color: Natural/Black
- Unit: mm

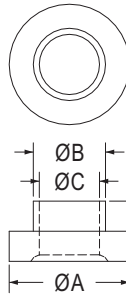

【 TW-6A 】

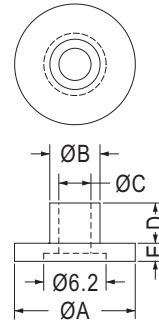

【 TW-66, TW-164 】

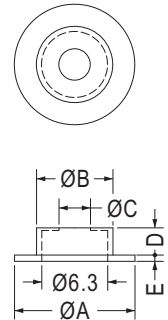

【 TW-105 】

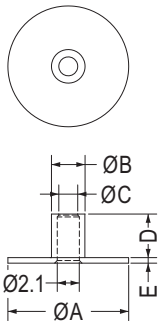

【 TW-210 】

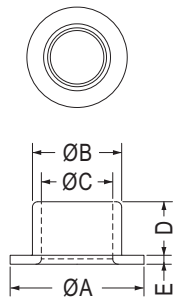

【 TW-211, TW-212, TW-239 】

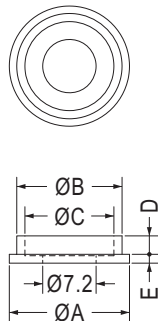

【 TW-238 】

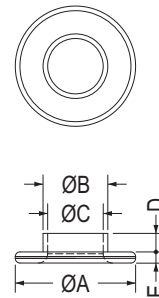

【 TW-288 】

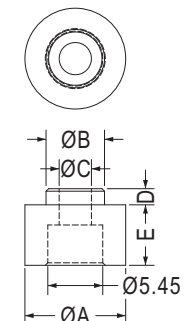

【 TW-300 】

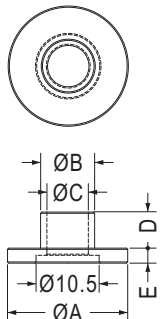

【 TW-302 】

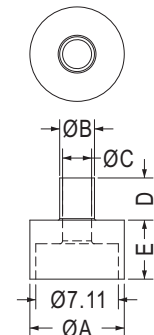

【 TW-337 】

Part No.	A	B	C	D	E	Package
TW-6A	6.2	3.55	3.0	1.4	1.2	2000
TW-66	12.0	5.0	3.2	4.0	1.8	
TW-105	11.5	7.3	3.1	2.6	0.6	
TW-164	6.6	3.5	2.5	11.0	5.0	
TW-210	11.5	3.2	1.8	4.15	0.53	2000
TW-211	15.0	10.0	8.0	6.0	1.0	
TW-212	9.0	5.0	4.2	3.0	1.0	
TW-238	16.2	14.2	12.0	2.49	1.19	
TW-239	2.4	1.6	1.2	0.6	0.3	
TW-288	13.0	7.0	6.0	2.0	1.2	
TW-300	10.0	5.8	3.2	1.6	6.0	
TW-302	20.0	9.0	6.9	6.0	2.5	1000
TW-337	8.13	3.0	2.5	3.63	5.08	2000



- Material: Nylon 46 (UL)/PPS (UL)
- Flame Class: 94V-0
- Color: Natural/Black
- Unit: mm

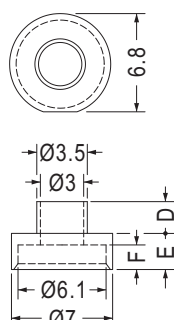

【 TW-124 】

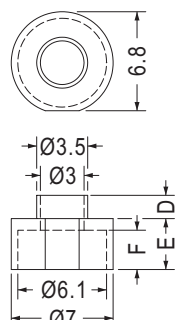

Part No.	D	E	F	Package
TW-71	2.4	6.5	4.6	2000
TW-92	1.6	3.5	2.7	
TW-93	2.2	3.8	3.0	
TW-98	1.6	3.5	2.1	
TW-103	2.4	3.9	2.0	1000
TW-114	1.6	5.0	4.2	
TW-118	2.4	4.9	3.0	
TW-119	1.6	3.8	3.0	2000
TW-120	1.6	2.8	2.0	
TW-124	2.2	2.5	1.7	
TW-201	3.2	5.0	4.2	
TW-309	2.8	4.2	3.4	

# 電晶體墊片 TRANSISTOR WASHER

用途：鎖於電晶體上，避免晶體外殼與散熱片間造成短路。



- Material: PPS (UL)
- Flame Class: 94V-0
- Color: Natural(Brown)/Black
- Unit: mm

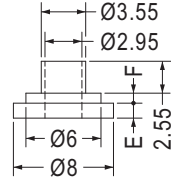
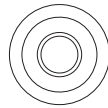

Part No.	E	F	Package
TW-147	1.2	0.8	2000
TW-297	1.0	1.6	

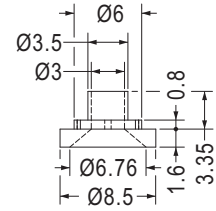
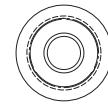

- Color: Natural(Brown)

Part No.	Package
TW-180	2000



- Material: POM
- Color: Black
- Unit: mm

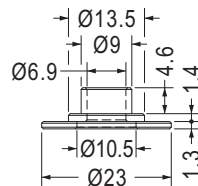
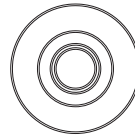

Part No.	Package
TW-312	1000

- Material: Nylon 6T (UL)
- Flame Class: 94V-0
- Color: Natural
- Unit: mm

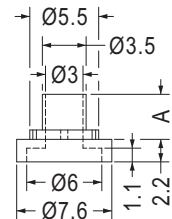
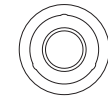

Part No.	A	Package
TW-236	3.6	2000
TW-277	4.2	

6

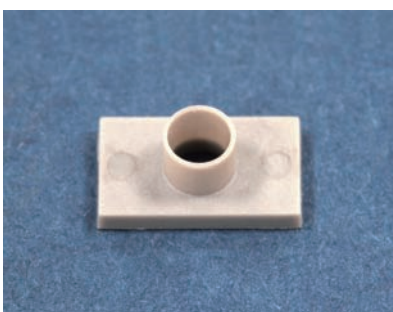

- Material: PET
- Color: Gray
- Unit: mm

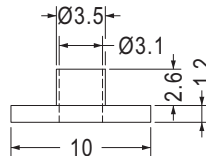

Part No.	Package
TW-241	1000



- Material: PPS (UL)
- Flame Class: 94V-0
- Color: Black
- Unit: mm

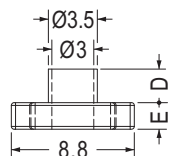
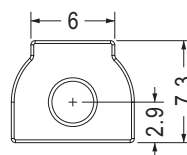

Part No.	D	E	Package
TW-298	2.4	1.9	1000
TW-299	1.6	1.3	

## 零件墊片 WASHER

用途：做為零件之墊片。



- Material: Nylon 66 (UL)
- Flame Class: 94V-2/94V-0
- Color: Natural/Black
- Unit: mm

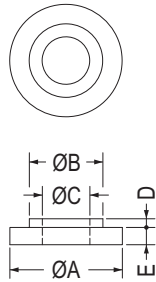

Part No.	A	B	C	D	E	Package
FUG-1	16.8	12.5	9.5	2.0	2.0	1000
FUG-3	11.1	7.9	6.4	0.81	0.81	

Part No.	A	B	C	D	E	Package
TWC-7	7.6	5.84	3.25	1.27	0.38	2000
TWC-12	19.2	9.4	6.5	0.8	1.2	
TWC-13	15.0	10.0	5.5	1.2	2.5	
TWC-16	15.0	9.9	4.2	2.0	1.5	
TWC-21	9.52	6.35	4.32	0.81	0.81	1000
TWC-22	25.0	13.8	12.2	2.0	2.0	2000
TWC-23	10.0	5.9	5.2	1.7	1.3	1000
TWC-24	25.0	15.8	14.2	2.0	2.0	
TWC-25	25.0	17.8	16.2	2.0	2.0	
TWC-26	25.0	15.8	12.2	2.0	2.0	
TWC-27	15.0	6.9	3.1	2.0	1.5	2000
TWC-28	15.0	8.9	6.2	2.0	1.5	
TWC-29	9.52	7.82	4.98	0.81	1.57	
TWC-30	15.0	6.9	4.2	2.0	1.5	
TWC-31	15.0	8.9	3.1	2.0	1.5	
★TWC-39	10.1	6.6	5.1	6.4	1.6	
★TWC-40	15.0	9.9	5.2	2.0	1.5	
★TWC-41	18.0	11.9	8.2	2.5	1.5	
★TWC-43	9.53	6.35	3.56	1.57	2.36	

- Material: PC+ABS (UL)

Part No.	A	B	C	D	E	Package
TWC-3	13.0	8.5	5.5	1.0	2.0	2000
TWC-5	13.0	8.5	5.5	1.0	7.0	
TWC-6	14.6	10.1	4.5	0.4	1.9	

- Material: PPS(UL)

Part No.	A	B	C	D	E	Package
TWC-35	10.1	6.6	5.1	2.4	1.6	2000
TWC-38	13.0	7.8	4.1	2.9	3.0	

## 絕緣柱 ROUND SPACER

用途：用於零件之絕緣使用。



- Material: Nylon 66 (UL)
- Flame Class: 94V-2/94V-0
- Color: Natural/Black
- Unit: mm

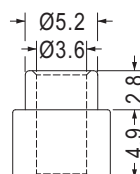
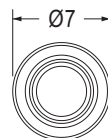

Part No.	Package
TW-133	2000

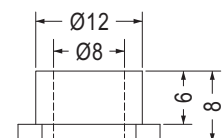
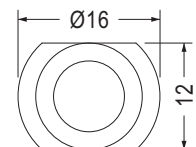

Part No.	Package
TW-125	1000

# 絕緣柱 ROUND SPACER

用途：用於M3螺絲或螺母之絕緣使用。

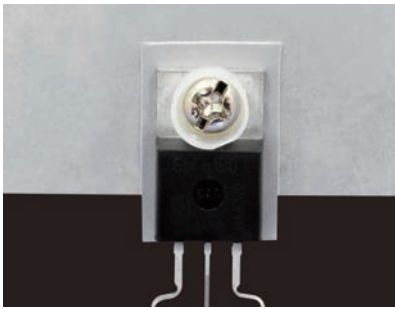

- Material: Nylon 46 (UL)/PPS (UL)
- Flame Class: 94V-0
- Color: Natural
- Unit: mm

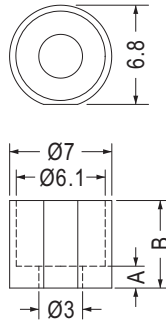

Part No.	A	B	Package
UT-1	1.5	6.0	2000
UT-3	1.4	3.5	
UT-5	0.8	3.8	
UT-6	0.3	2.3	
UT-12	0.3	2.3	
UT-13	0.3	1.9	

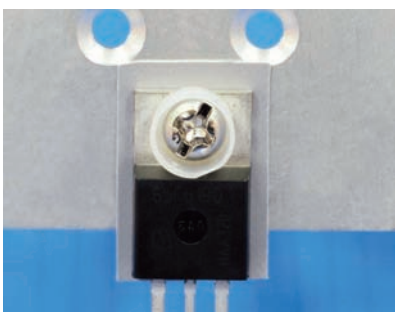

- Material: Nylon 66 (UL)
- Flame Class: 94V-2
- Color: Natural
- Unit: mm

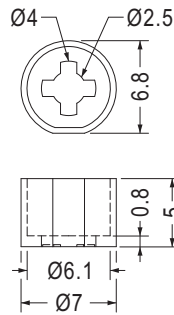

Part No.	Package
UT-17	1000

6

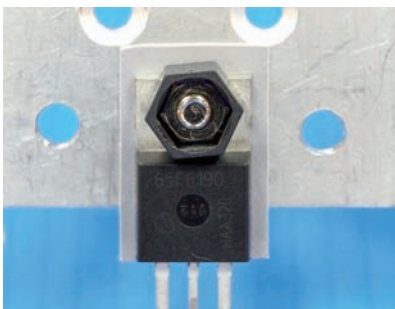

- Material: Nylon 46 (UL)
- Flame Class: 94V-0
- Color: Natural
- Unit: mm

用途：用於M3螺母之絕緣使用。

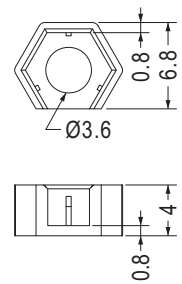
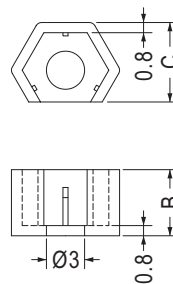
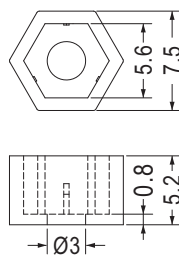
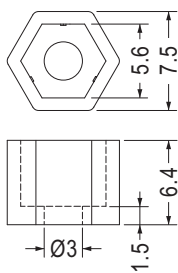

- Material: PPS (UL)
- Flame Class: 94V-0
- Color: Black

Part No.	Package
UT-2	1000

Part No.	Package
UT-8	2000

Part No.	B	C	Package
UT-4	5.2	6.25	2000
UT-7	4.0	5.8	
UT-11	4.0	6.25	

Part No.	Package
UT-19	2000

# 電晶體墊片 TRANSISTOR WASHER

用途：鎖於電晶體上，避免晶體外殼與散熱片間造成短路。

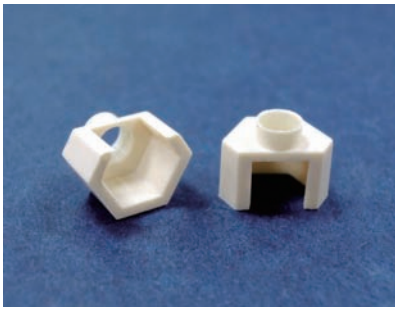

- Material: Nylon 46 (UL)
- Flame Class: 94V-0
- Color: Natural
- Unit: mm

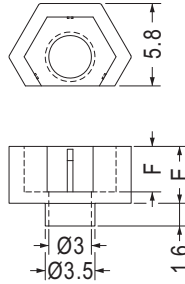

Part No.	E	F	Package
TW-190	4.0	3.2	2000
TW-191	5.0	4.2	

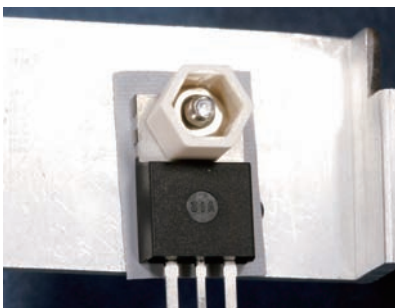

- Material: Nylon 66 (UL)
- Flame Class: 94V-2/94V-0
- Color: Natural/Black
- Unit: mm

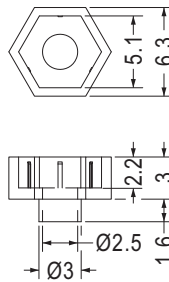

Part No.	Package
TW-290	2000

- Material: Nylon 46 (UL)/PPS (UL)
- Flame Class: 94V-0
- Color: Natural/Black
- Unit: mm

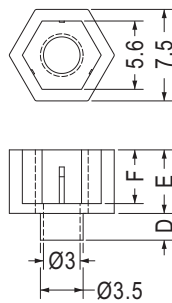

Part No.	D	E	F	Package
TW-72	1.6	6.4	5.0	2000
TW-94	1.6	5.0	4.2	
TW-95	2.2	5.2	4.4	
TW-112	1.6	4.0	3.2	
TW-121	2.4	6.3	4.4	
TW-122	1.6	5.2	4.4	
TW-248	1.6	3.4	2.6	

- Material: PPS (UL)
- Flame Class: 94V-0
- Color: Black
- Unit: mm

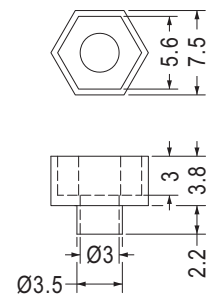

Part No.	Package
TW-285	2000

# 絕緣柱 SPACER SUPPORT

用途：做為PC板與機板之絕緣用。



- Material: Nylon 66 (UL)/  
Nylon 6 (UL)/PC (UL)
- Flame Class: 94V-2/94V-0
- Color: Natural/Black
- Unit: mm

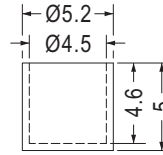
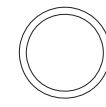
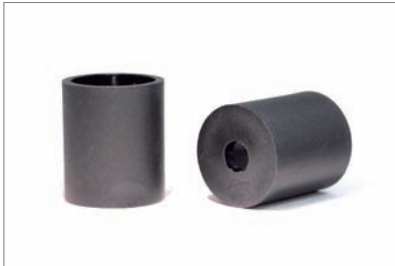

Part No.	Package
U-33	2000

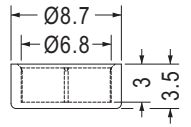
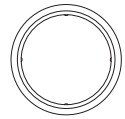

Part No.	Package
U-40	2000

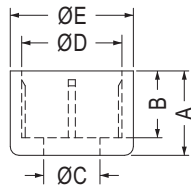
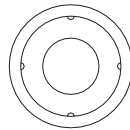
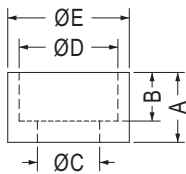
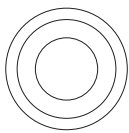

【 U-4, U-46 】

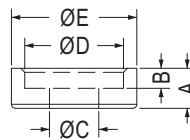
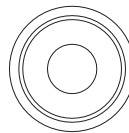

【 U-8, U-12, U-23 】

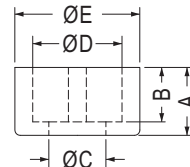
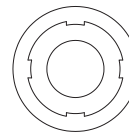

【 U-17, U-18, U-19 】

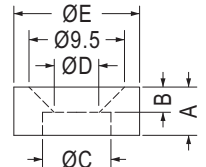
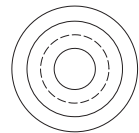

【 U-25 】

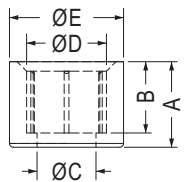
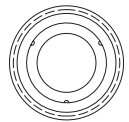

【 U-27 】

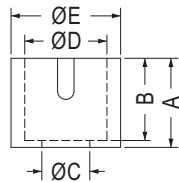
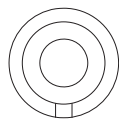

【 U-29 】

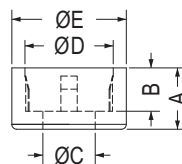
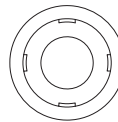

【 U-30 】

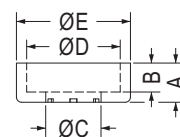
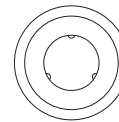

【 U-31 】

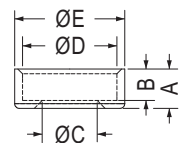
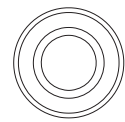

【 U-37 】

Part No.	A	B	C	D	E	Package
U-4	4.9	3.8	3.2	5.7	7.0	2000
U-5	4.6	3.2	4.1	6.5	8.0	
U-6	10.0	7.0	3.0	8.5	11.0	1000
U-7	3.1	2.1	3.0	5.5	7.5	2000
U-8	3.0	1.5	3.7	7.4	9.4	
U-10	4.6	3.6	3.6	7.6	9.1	
U-11	4.0	3.0	2.9	6.3	7.8	
U-12	4.2	2.7	3.2	5.3	8.74	
U-14	6.5	6.0	6.0	8.0	9.0	
U-15	7.1	5.1	4.8	8.9	15.7	
U-16	5.1	4.0	7.0	10.0	12.0	
U-17	3.8	3.05	3.2	5.4	7.0	

Part No.	A	B	C	D	E	Package
U-18	6.4	3.4	3.2	5.0	7.0	2000
U-19	6.0	3.0	2.8	5.1	7.5	
U-23	3.8	2.25	3.4	5.95	8.0	
U-25	4.8	2.5	6.8	4.5	12.5	
U-27	4.5	3.75	3.1	4.2	6.0	
U-28	4.8	3.3	3.4	6.5	9.5	
U-29	6.5	6.0	3.5	6.0	8.0	
U-30	3.75	2.65	3.2	5.4	7.0	
U-31	2.3	1.7	3.25	5.5	6.7	
U-37	2.5	2.0	3.5	6.0	7.0	
U-39	5.1	4.0	3.2	10.0	12.0	500
U-42	20.0	17.5	5.2	14.0	17.0	
★U-46	4.9	3.8	5.2	5.7	7.0	2000

## 絕緣柱 SPACER SUPPORT

用途：做為PC板與機板之絕緣用。



- Material: Nylon 46 (UL)/PPS (UL)
- Flame Class: 94V-0
- Color: Natural/Black
- Unit: mm

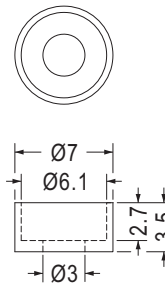

Part No.	Package
UT-14	2000

## 絕緣柱 ROUND SPACER

用途：用於零件之絕緣使用。



- Material: Nylon 66 (UL)
- Flame Class: 94V-2/94V-0
- Color: Natural/Black
- Unit: mm

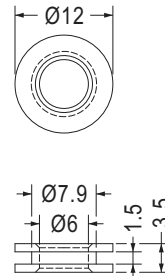

Part No.	Package
UPA-1	1000

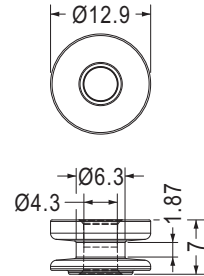

Part No.	Package
UPA-2	1000

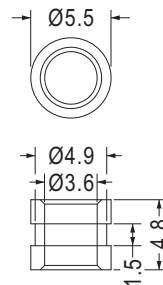

- Material: POM

Part No.	Package
UPA-4	1000



- Material: PC (UL)

Part No.	Package
UPB-1	1000

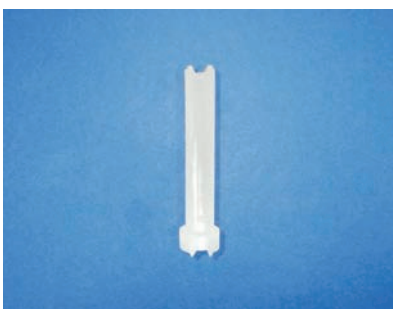

- Material: PC (UL)
- Flame Class: 94V-2/94V-0
- Color: Transparent
- Unit: mm

用途：做為PC板與機板之絕緣用。

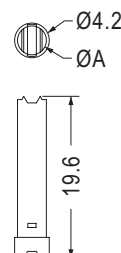

Part No.	A	Package
EM-580	3.5	1000
EM-582	3.0	

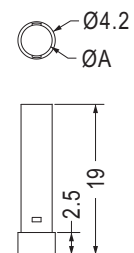

Part No.	A	Package
EM-581	3.5	1000
EM-583	3.0	

# 電晶體墊片 TRANSISTOR WASHER

用途：保護TO-05晶體立於PC板上，且高度一致，不斷腳。

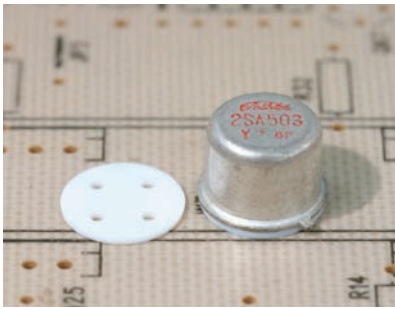

- Material: Nylon 66 (UL)
- Flame Class: 94V-2/94V-0
- Color: Natural/Black
- Unit: mm

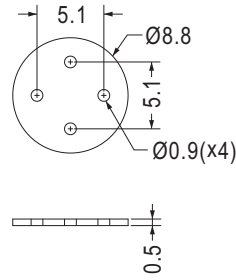

Part No.	Package
TO-05-1	2000

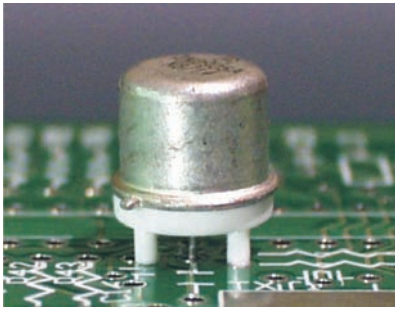

- Material: Nylon 66 (UL)/PBT (UL)
- Flame Class: 94V-2/94V-0
- Color: Natural/Black
- Unit: mm

用途：保護TO-05晶體立於PC板上，使接腳不彎曲、折斷、短路，且高度一致，增加可靠度。

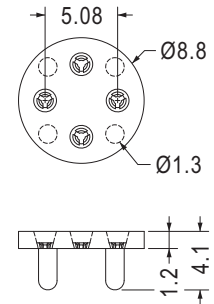
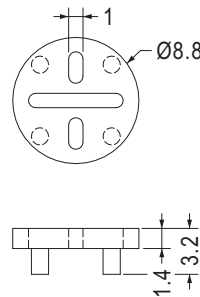
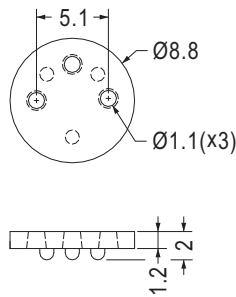

Part No.	Package
TO-05S	1000

Part No.	Package
TO-05	1000

Part No.	Package
TO-05C	1000



- Material: Nylon 66 (UL)/PBT (UL)
- Flame Class: 94V-2/94V-0
- Color: Natural/Black
- Unit: mm

用途：保護TO-18晶體立於PC板上，使接腳不彎曲、折斷、短路，且高度一致，增加可靠度。

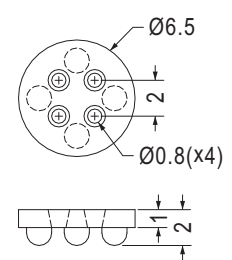
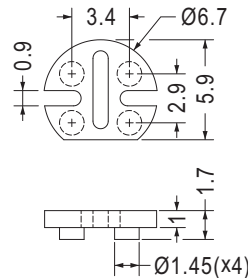
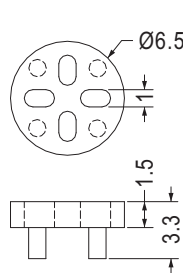

Part No.	Package
TO-18	1000

Part No.	Package
TO-18S	2000

Part No.	Package
TO-18M	2000



- Material: Nylon 66 (UL)
- Flame Class: 94V-2/94V-0
- Color: Natural/Black
- Unit: mm

用途：用於橋式整流器或電晶體之墊高。

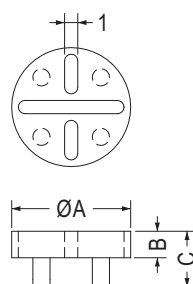

Part No.	A	B	C	Package
BW-1	9.0	2.0	4.2	2000
BW-2	14.0	1.0	2.1	

## IC座 IC HOUSING

用途：8 PIN鐵殼IC之架高與絕緣。



- Material: Nylon 66 (UL)
- Flame Class: 94V-2/94V-0
- Color: Natural/Black
- Unit: mm

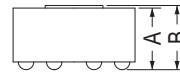
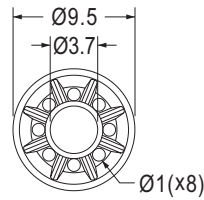

Part No.	A	B	Package
ICV-1	2.0	2.2	2000
ICV-2	4.8	5.0	

## 電晶體墊片 TRANSISTOR WASHER

用途：保護TO-92功率晶體立於PC板上，高度一致，不斷腳。



- Material: Nylon 66 (UL)
- Flame Class: 94V-2/94V-0
- Color: Natural/Black
- Unit: mm

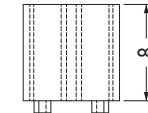
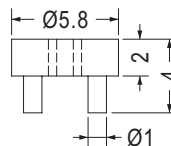
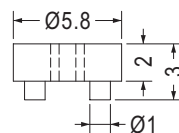
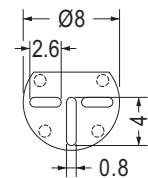
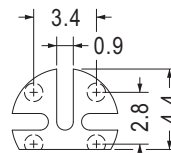
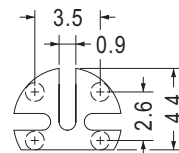

Part No.	Package
TO-92	2000

Part No.	Package
TO-92-4	2000

Part No.	Package
TO-92-9	1000

## 電晶體座 TRANSISTOR HOUSING

用途：保護TO-92功率晶體立於PC板上，使接腳不彎曲、折斷、短路，且高度一致。



- Material: Nylon 66 (UL)
- Flame Class: 94V-2/94V-0
- Color: Natural/Black
- Unit: mm

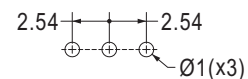
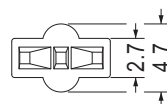

MOUNTING HOLE

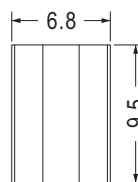

Part No.	Package
TOA-92-9.5	2000



- Material: Nylon 66 (UL)
- Flame Class: 94V-2/94V-0
- Color: Natural/Black
- Unit: mm

用途：保護晶體立於PC板上，使接腳不彎曲、折斷、短路，且高度一致。

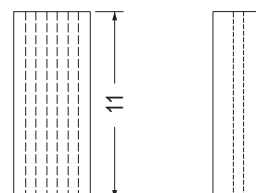
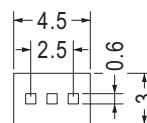

Part No.	Package
TR3-11-1	1000

## 電晶體墊片 TRANSISTOR WASHER

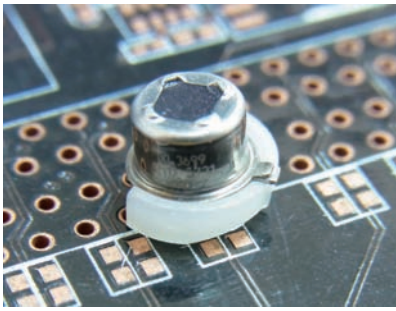

- Material: Nylon 66 (UL)
- Flame Class: 94V-2/94V-0
- Color: Natural/Black
- Unit: mm

用途：保護晶體立於PC板上，使接腳不彎曲、折斷、短路，且高度一致，增加可靠度。

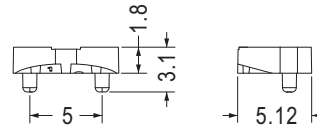
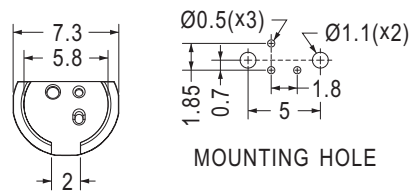

Part No.	Package
TRB-2	2000

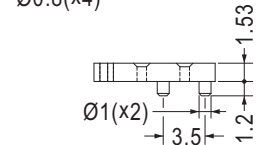
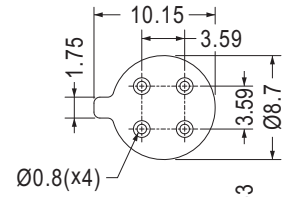

Part No.	Package
TRB-19	2000

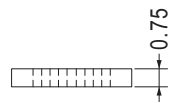
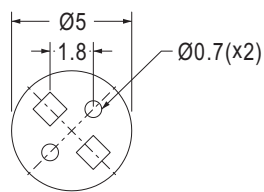

Part No.	Package
TRB-1	2000

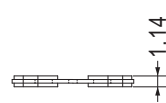
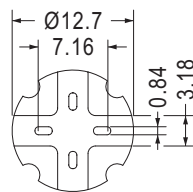

Part No.	Package
TO-5	1000

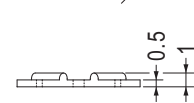
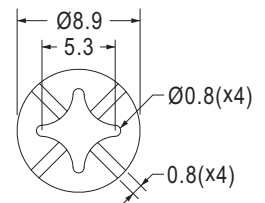

Part No.	Package
TO-5-1	2000

## 電晶體蓋 TRANSISTOR COVER



- Material: Nylon 66 (UL)
- Flame Class: 94V-2/94V-0
- Color: Natural/Black
- Unit: mm

用途：用於TO-3功率晶體之外殼絕緣。

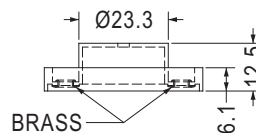
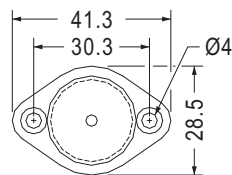

Part No.	Package
TRC-1	200

## TO-3電晶體座 TRANSISTOR HOUSING

用途：鎖於TO-3功率晶體與散熱片之間，作為絕緣與保護之用。



- Material: Nylon 66 (UL)
- Flame Class: 94V-2/94V-0
- Color: Natural/Black
- Unit: mm

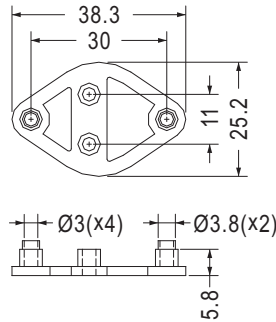

Part No.	Package
TR-4	500

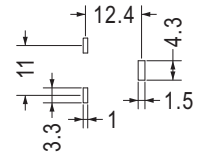
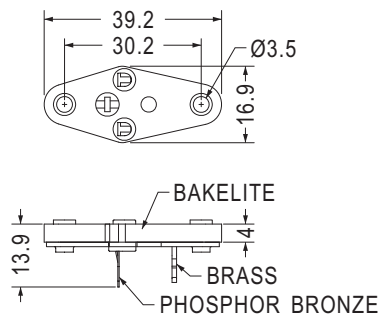

MOUNTING HOLE

Part No.	Package
TO-3APF	250

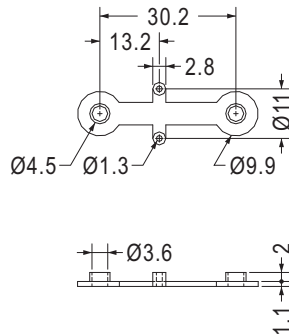

Part No.	Package
TR-6	1000

## TO-66電晶體座 TRANSISTOR HOUSING

用途：鎖於TO-66功率晶體與散熱片之間，作為絕緣與保護之用。



- Material: Nylon 66 (UL)
- Flame Class: 94V-2/94V-0
- Color: Natural/Black
- Unit: mm

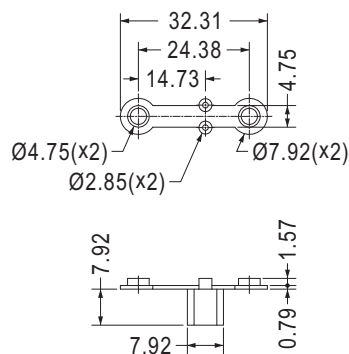

Part No.	Package
TO-66	1000



- Material: Nylon 46 (UL)
- Flame Class: 94V-0
- Color: Natural/Black
- Unit: mm

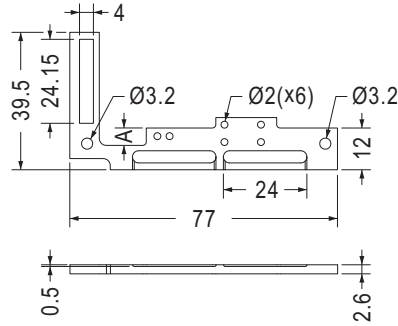

Part No.	A	Package
EM-51	5.0	500
EM-63	5.5	



- Material: Nylon 6T (UL)
- Flame Class: 94V-0
- Color: Natural/Black
- Unit: mm

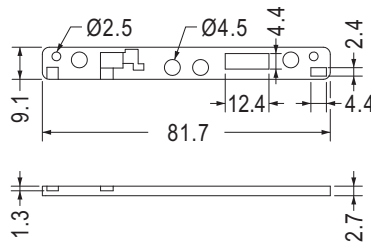

Part No.	Package
EMD-106	500

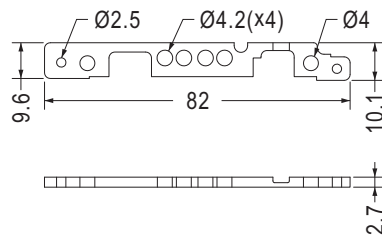

Part No.	Package
EMD-42	500

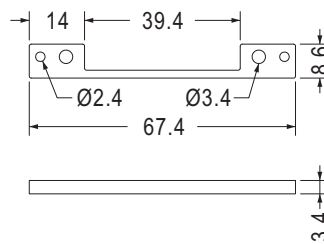

Part No.	Package
EMD-142	500

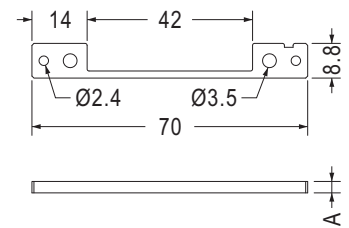

Part No.	A	Package
EMD-108	2.9	500
EMD-109	3.4	

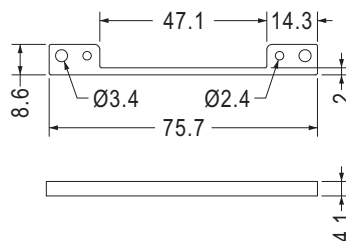

Part No.	Package
EMD-260	1000

- Material: Nylon 46 (UL)
- Flame Class: 94V-0
- Color: Natural/Black
- Unit: mm

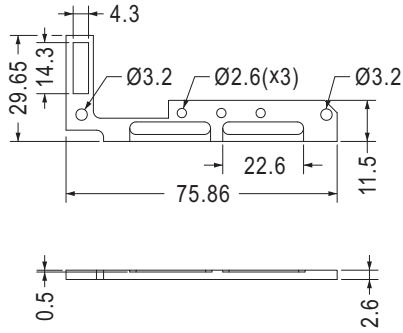

Part No.	Package
EML-7	200

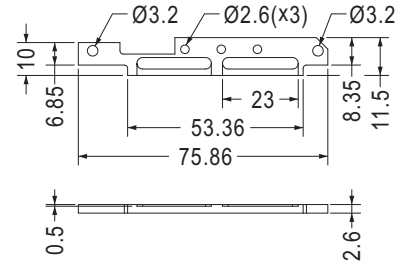

Part No.	Package
EML-10	500

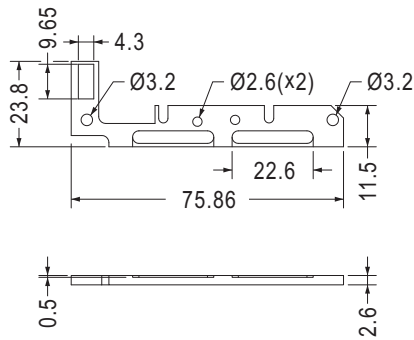
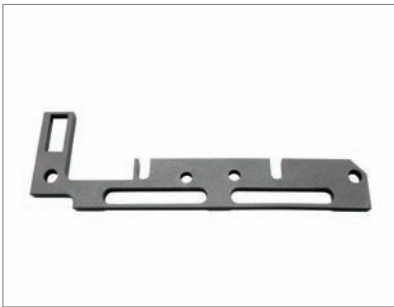

Part No.	Package
EML-13	200

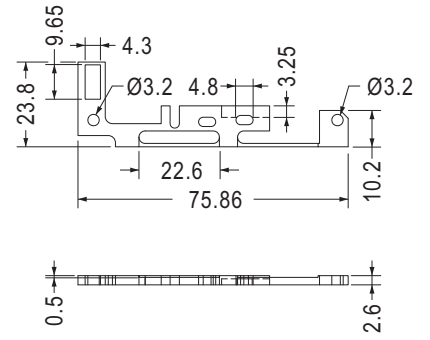

Part No.	Package
EML-23	200

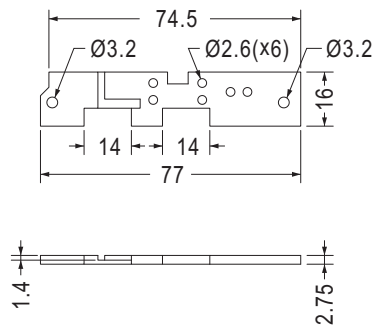

Part No.	Package
EML-22	500

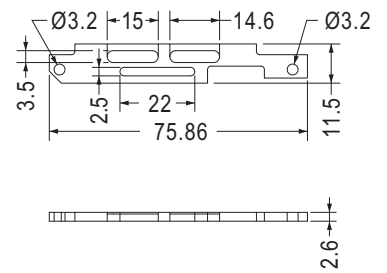

Part No.	Package
EML-52	500

# 零件墊座 PARTS HOUSING

用途：用於電源供應器，球擊測試的保護。

- Material: PC (UL)
- Flame Class: 94V-0
- Color: Black
- Unit: mm

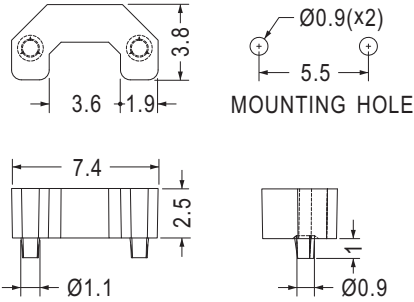

Part No.	Package
EMD-25	2000

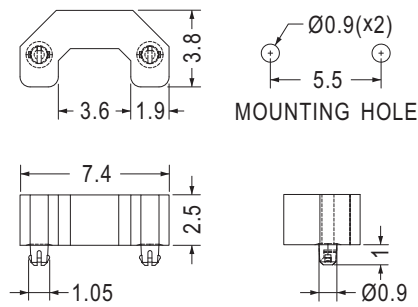

Part No.	Package
EMD-118	2000

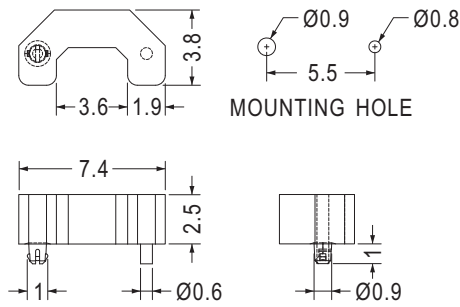

Part No.	Package
EMD-203	2000

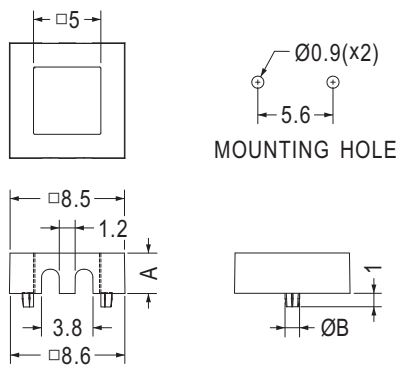

Part No.	A	B	Package
EMD-14	2.5	0.9	2000
EMD-136	3.0	1.08	

# 零件墊座 PARTS HOUSING

用途：用於電源供應器，球擊測試的保護。

- Material: PC (UL)
- Flame Class: 94V-0
- Color: Black
- Unit: mm

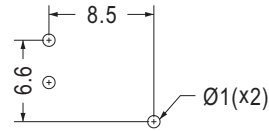
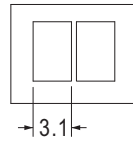
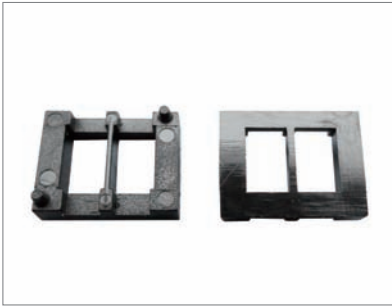

MOUNTING HOLE

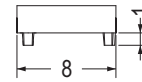
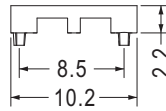

Part No.	Package
EMD-29	2000

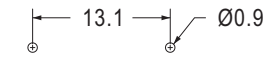
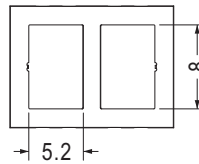
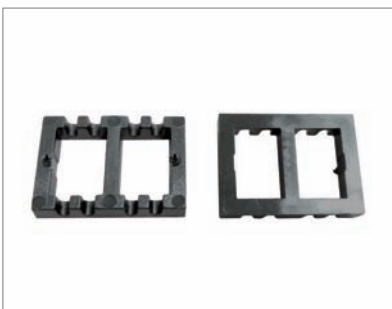

MOUNTING HOLE

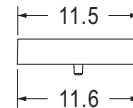
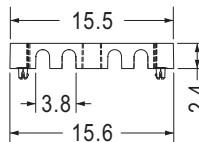

Part No.	Package
EMD-147	1000

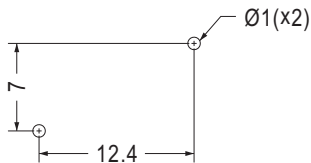
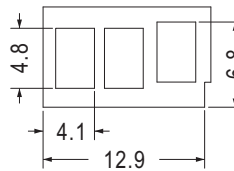

MOUNTING HOLE

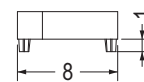
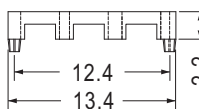

Part No.	Package
EMD-131	1000

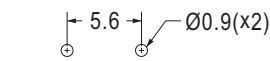
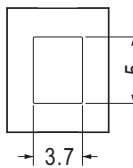

MOUNTING HOLE

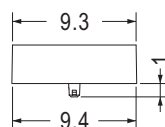
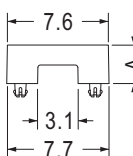

Part No.	A	Package
EMD-129	2.4	2000
EMD-140	2.9	

# 球擊緩衝墊片 IMPACT BUFFER PAD

用途：做為球擊測試之緩衝墊片。

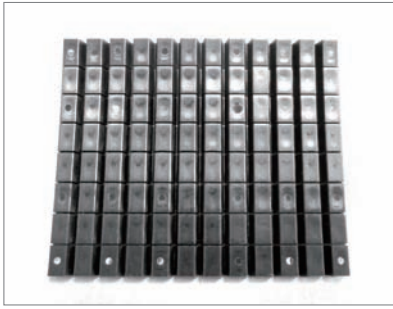

- Material: Nylon 66 (UL)
- Flame Class: 94V-2/94V-0
- Color: Black
- Unit: mm

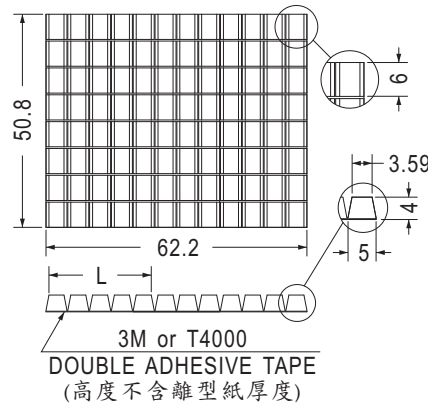

Part No.	L	Package
EMD-10-1	3.59	96PCS
EMD-10-2	8.79	
EMD-10-3	13.99	
EMD-10-4	19.19	
EMD-10-5	24.39	
EMD-10-6	29.59	

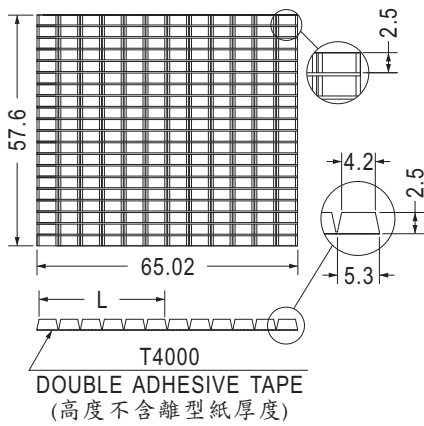

Part No.	L	Package
EM-18-1	4.2	240PCS
EM-18-2	9.65	
EM-18-3	15.1	
EM-18-4	20.5	
EM-18-5	25.95	
EM-18-6	31.4	

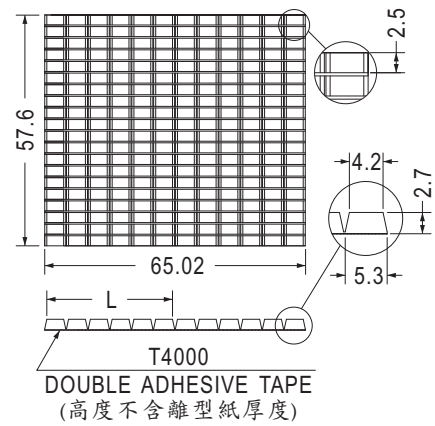

Part No.	L	Package
EMD-78-1	4.2	240PCS
EMD-78-2	9.65	
EMD-78-3	15.1	
EMD-78-4	20.5	
EMD-78-5	25.95	
EMD-78-6	31.4	

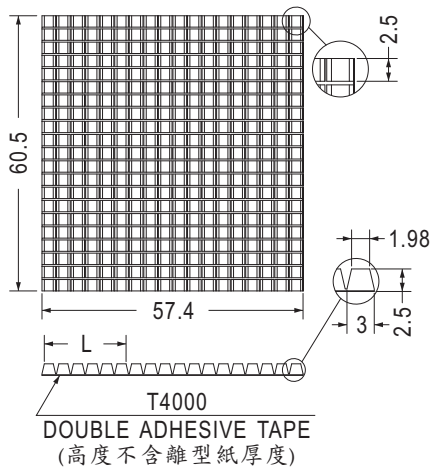

Part No.	L	Package
EM-40-1	1.98	378PCS
EM-40-2	5.18	
EM-40-3	8.38	
EM-40-4	11.58	
EM-40-5	14.78	
EM-40-6	17.98	

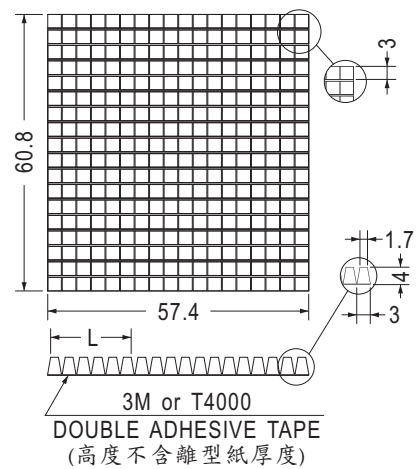

Part No.	L	Package
EM-535-1	1.7	324PCS
EM-535-2	4.9	
EM-535-3	8.1	
EM-535-4	11.3	
EM-535-5	14.5	
EM-535-6	17.7	

# 電晶體座 TRANSISTOR HOUSING

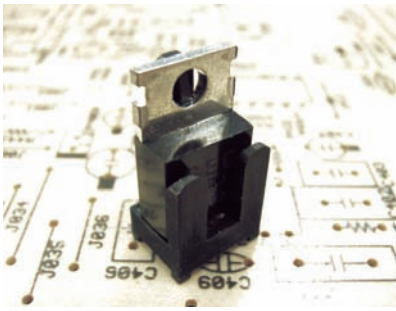

- Material: Nylon 66 (UL)
- Flame Class: 94V-2/94V-0
- Color: Natural/Black
- Unit: mm

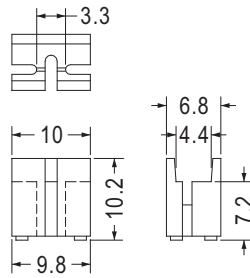

Part No.	Package
TR-1	1000

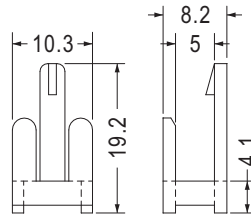

Part No.	Package
TR-2	1000

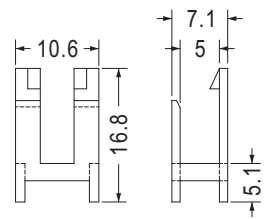

Part No.	Package
TR-5	1000

用途：保護TO-220包裝之晶體立於PC板上，使接腳不彎曲、折斷、短路、且高度一致，增加可靠性。

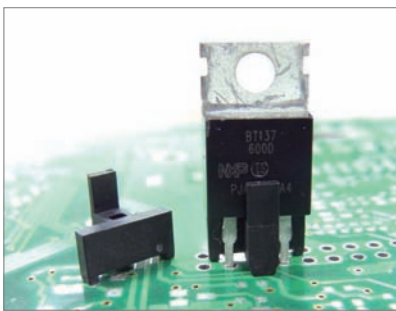

- Material: PBT (UL)
- Flame Class: 94V-0
- Color: Black
- Unit: mm

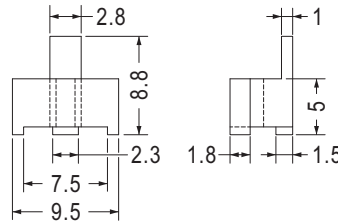
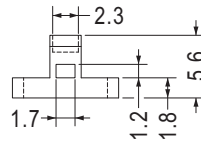

Part No.	Package
TR-30	1000

用途：保護晶體立於PC板上，使接腳不彎曲、折斷、短路，且高度一致。

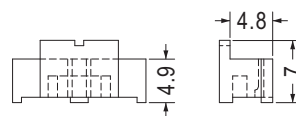
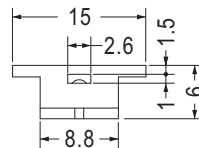
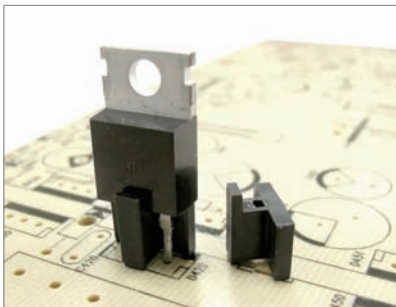

Part No.	Package
TR-7	1000

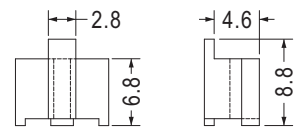
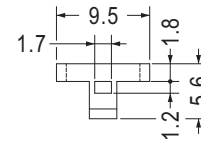

Part No.	Package
TR-8	1000



- Material: Nylon 66 (UL)
- Flame Class: 94V-2/94V-0
- Color: Natural/Black
- Unit: mm

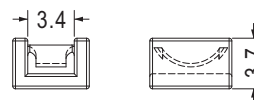
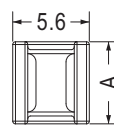

Part No.	A	Package
TR-34	4.2	1000
TR-36	6.0	
TR-38	4.6	

用途：保護TO-3P功率晶體，保護晶體立於PC板上，使接腳不彎曲、折斷、短路，且高度一致。

# 電晶體座 TRANSISTOR HOUSING

用途：保護晶體立於PC板上，使接腳不彎曲、折斷、短路，且高度一致。

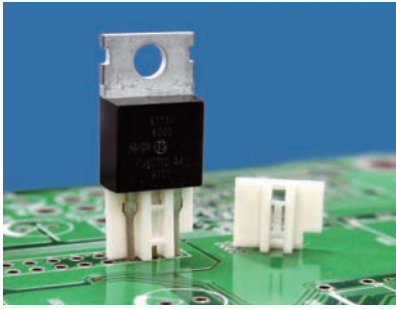

- Material: PBT (UL)
- Flame Class: 94V-0
- Color: Natural
- Unit: mm

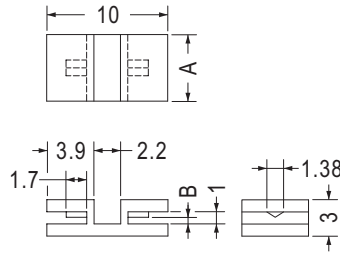

Part No.	A	B	Package
TR-10A	5.5	0.5~0.6	1000
TR-10S	5.5	0.4	
TR-17	7.5	0.5~0.6	

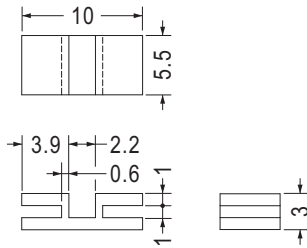

Part No.	Package
TR-10	1000

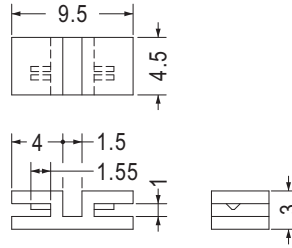

Part No.	Package
TR-11	1000

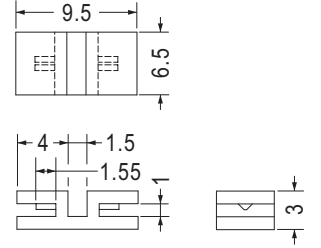

Part No.	Package
TR-13	1000

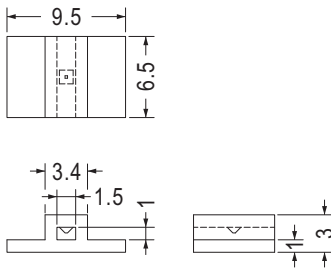

Part No.	Package
TR-14	1000

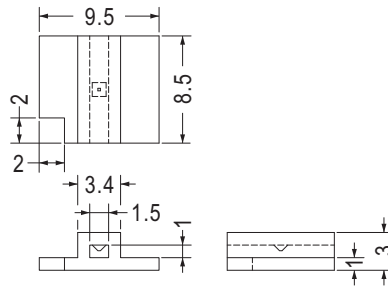

Part No.	Package
TR-16	1000

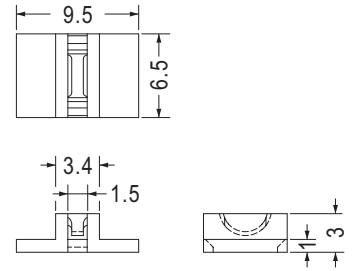

Part No.	Package
TR-21	1000

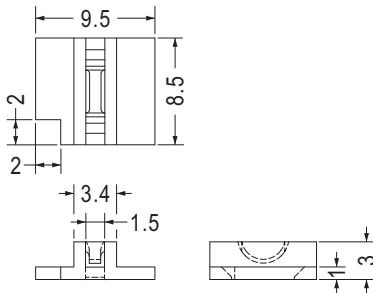

Part No.	Package
TR-22	1000

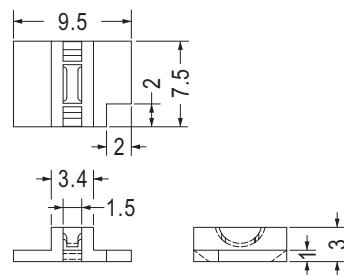

Part No.	Package
TR-29	1000

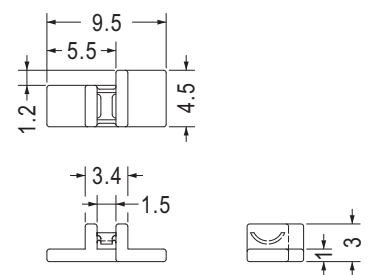

Part No.	Package
TR-35	1000

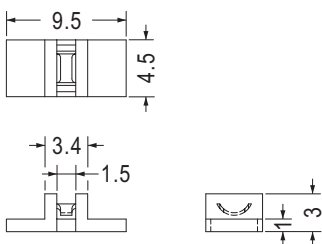

Part No.	Package
TR-23	1000

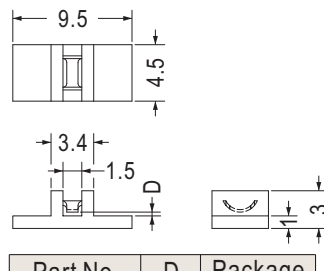

Part No.	D	Package
TR-23S	0.3	1000
TR-26	0.5	

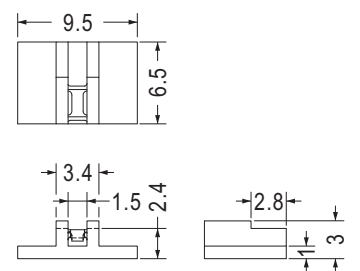

Part No.	Package
TR-45	1000

# 電晶體座 TRANSISTOR HOUSING

用途：保護晶體立於PC板上，使接腳不彎曲、折斷、短路，且高度一致。

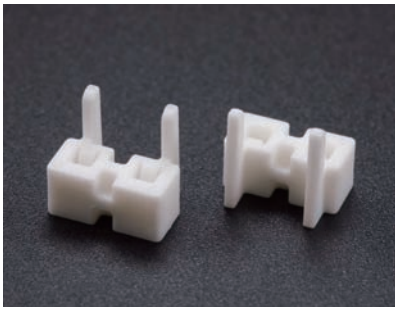

- Material: Nylon 66 (UL)
- Flame Class: 94V-2/94V-0
- Color: Natural/Black
- Unit: mm

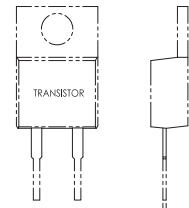
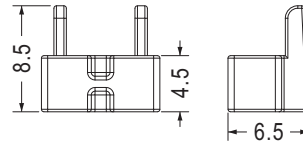
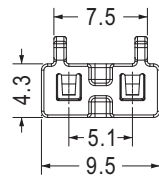

RECOMMEND TRANSISOR PIN THICKNESS 0.3~0.6

• Patented (專利品)

Part No.	Package
★TR-47	1000

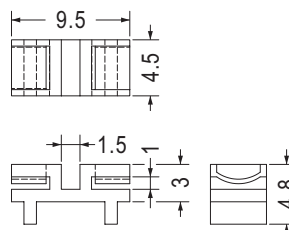

Part No.	Package
TR-24	1000

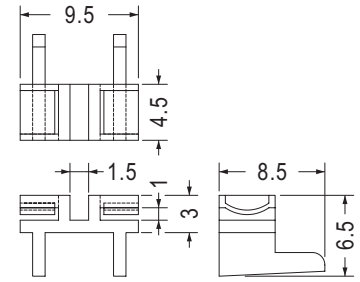

Part No.	Package
TR-25	1000

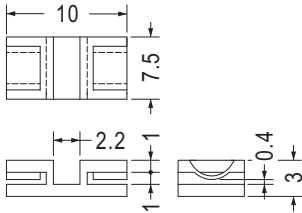

Part No.	Package
TR-18	1000

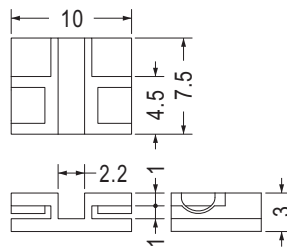

Part No.	Package
TR-37	1000

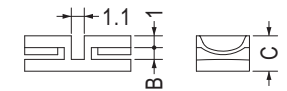
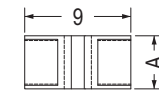
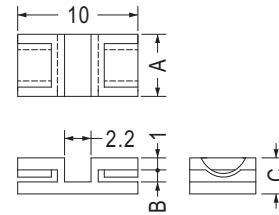

【TRG-4.5L】

- Material: Nylon 66 (UL)/PBT (UL)

Part No.	A	B	C	Package
TRG-3.5	3.5	1.0	3.0	1000
TRG-4	4.0	1.0	3.0	
TRG-4.5	4.5	1.0	3.0	
TRG-4.5L	4.5	1.0	3.0	
TRG-5	5.0	1.0	3.0	
TRG-5.5	5.5	1.0	3.0	
TRG-6	6.0	1.0	3.0	
TRG-6.5	6.5	1.0	3.0	
TRG-6.5L	6.5	1.3	3.3	
TRG-7	7.0	1.0	3.0	
TRG-7.5	7.5	1.0	3.0	
TRG-8	8.0	1.0	3.0	
TRG-8.5	8.5	1.0	3.0	
TRG-9	9.0	1.0	3.0	
TRG-9.5	9.5	1.0	3.0	
TRG-10	10.0	1.0	3.0	

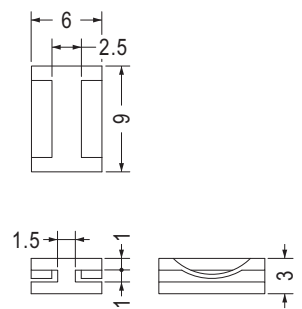

Part No.	Package
TRGS-9	1000

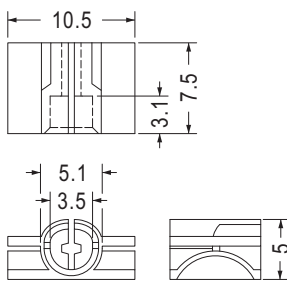

Part No.	Package
TRO-7.5	1000

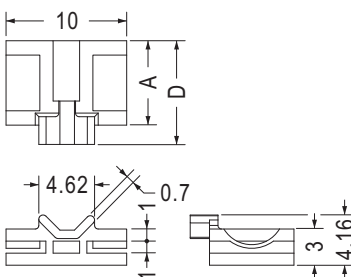

Part No.	A	D	Package
TRGV-5	5.0	6.6	1000
TRGV-6.7	6.7	8.3	
TRGV-7	7.0	8.6	

# 電晶體座 TRANSISTOR HOUSING

用途：保護晶體立於PC板上，使接腳不彎曲、折斷、短路，且高度一致。



- Material: Nylon 66 (UL)
- Flame Class: 94V-2/94V-0
- Color: Natural/Black
- Unit: mm

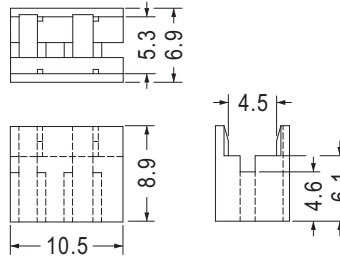

Part No.	Package
TRD-1	1000

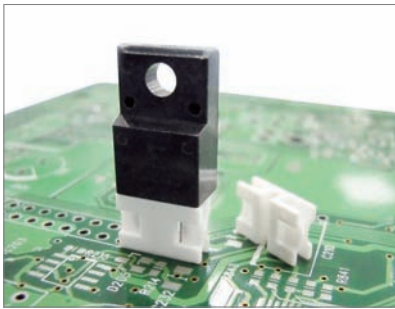

- Material: Nylon 66 (UL)/PBT (UL)
- Flame Class: 94V-2/94V-0
- Color: Natural/Black
- Unit: mm

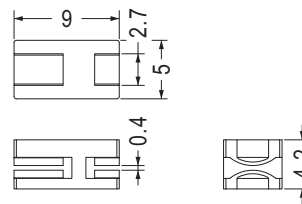

Part No.	Package
TRS-5	500

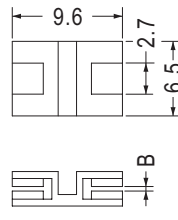

Part No.	B	Package
TRU-6.5	0.4	1000
TRU-6.5PV05	0.5	

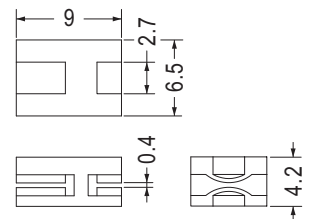

Part No.	Package
TRS-6.5	1000

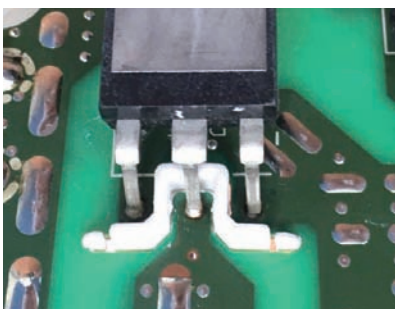

- Material: Nylon 66 (UL)
- Flame Class: 94V-2/94V-0
- Color: Natural/Black
- Unit: mm

用途：保護電晶體接腳間之絕緣，不使接腳短路。

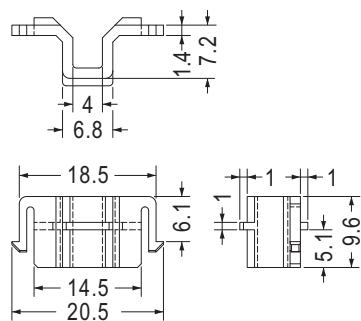

Part No.	Package
TRGL-1	1000

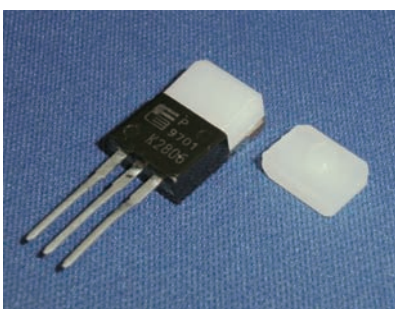

- Material: Nylon 66 (UL)
- Flame Class: 94V-2/94V-0
- Color: Natural/Black
- Unit: mm

用途：用於TO-220功率晶體組裝。

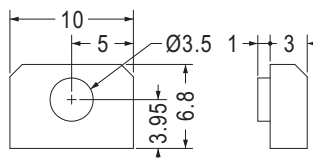

Part No.	Package
TRF-1	2000

# 電晶體座 TRANSISTOR HOUSING

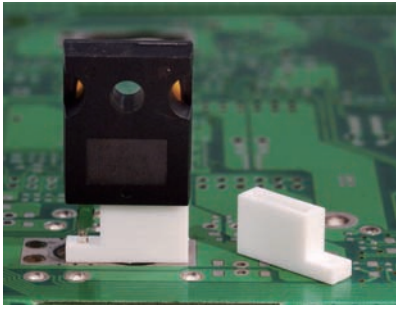

- Material: Nylon 66 (UL)
- Flame Class: 94V-2/94V-0
- Color: Natural/Black
- Unit: mm

用途：保護TO-3P功率晶體，保護晶體立於PC板上，使接腳不彎曲、折斷、短路，且高度一致。

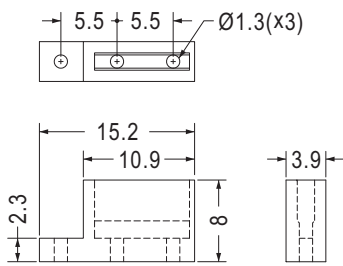

Part No.	Package
TRWA-1	1000

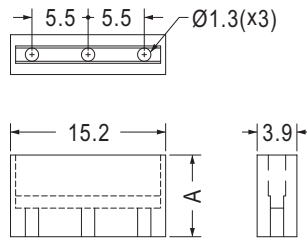

Part No.	A	Package
TRW-8	8.0	1000
TRW-10	10.0	

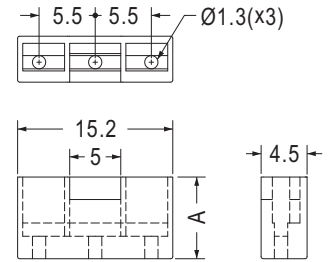

Part No.	A	Package
TRWF-8	8.0	1000
TRWF-10	10.0	

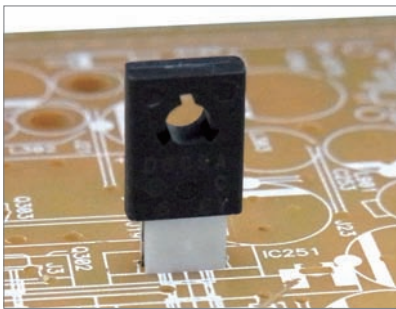

- Material: Nylon 66 (UL)
- Flame Class: 94V-2/94V-0
- Color: Natural/Black
- Unit: mm

用途：保護晶體立於PC板上，使接腳不彎曲、折斷、短路，且高度一致。

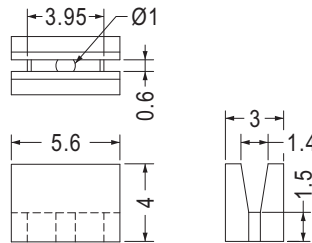

Part No.	Package
TR-9	2000

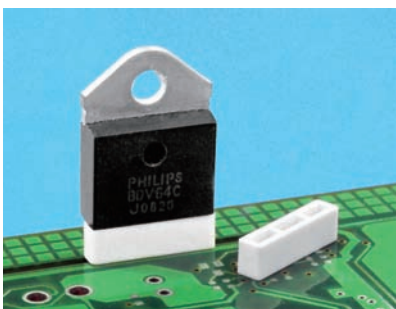

- Material: PBT (UL)
- Flame Class: 94V-0
- Color: Natural
- Unit: mm

用途：適用於TO-247功率晶體，保護晶體立於PC板上，使接腳不彎曲、折斷、短路，且高度一致。

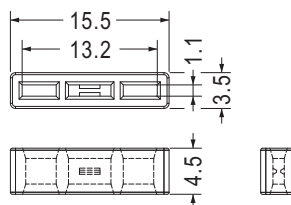

Part No.	Package
TRW3-2	1000

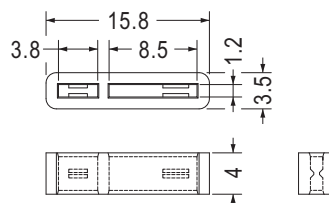

Part No.	Package
TRW3-6	1000

# 電晶體座 TRANSISTOR HOUSING

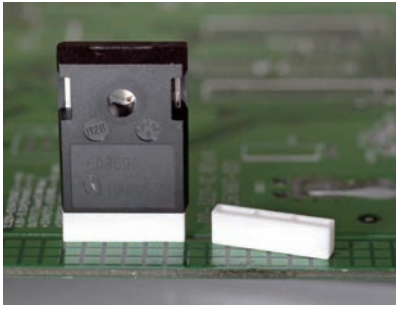

- Material: Nylon 66 (UL)
- Flame Class: 94V-2/94V-0
- Color: Natural/Black
- Unit: mm

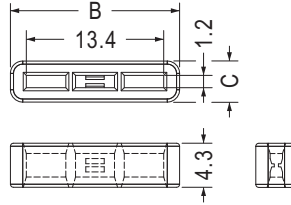

Part No.	B	C	Package
TRW3-3	16.5	4.0	1000
TRW3-7	15.0	2.8	

用途：適用於功率晶體，保護晶體立於PC板上，使接腳不彎曲、折斷、短路，且高度一致。

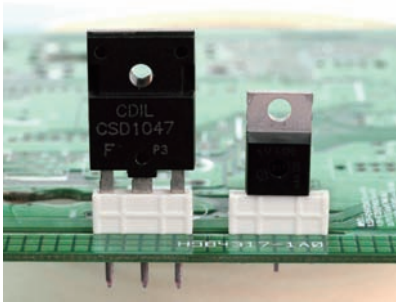

- Material: PBT (UL)
- Flame Class: 94V-0
- Color: Natural/White
- Unit: mm

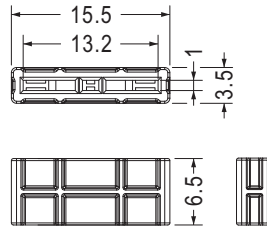

Part No.	Package
TRW3-4	1000

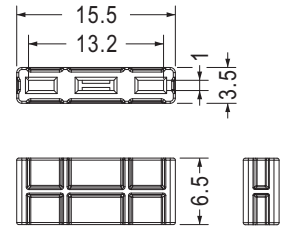

Part No.	Package
TRW3-5	1000

用途：保護晶體立於PC板上，使接腳不彎曲、折斷、短路，且高度一致。

6



- Material: Nylon 66 (UL)
- Flame Class: 94V-2/94V-0
- Color: Natural/Black
- Unit: mm

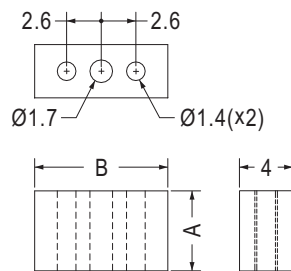

Part No.	A	B	Package
TR3-3S	3.0	9.8	1000
TR3-3	3.7	9.8	
TR3-4	4.0	9.8	
TR3-5	5.0	10.0	
TR-3	6.0	9.8	
TR3-7	7.0	9.8	
TR3-8.5	8.5	9.8	
TR3-9	9.0	9.8	
TR3-9.5	9.5	9.8	

用途：保護TO-220晶體立於PC板上，使接腳不彎曲、折斷、短路，且高度一致，增加可靠度。

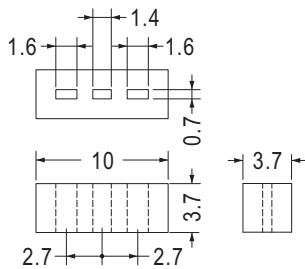

Part No.	Package
TR-19	1000

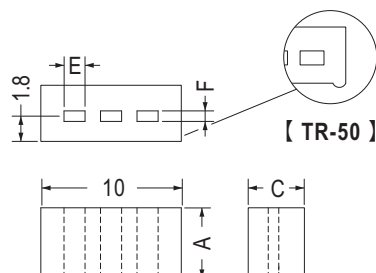

Part No.	A	C	E	F	Package
TR-12	5.0	4.0	1.5	0.75	1000
TR-31	3.0	3.0	1.5	0.75	
TR-50	5.0	4.3	1.7	1.0	

# 電晶體座 TRANSISTOR HOUSING

用途：保護晶體立於PC板上，使接腳不彎曲、折斷、短路，且高度一致。

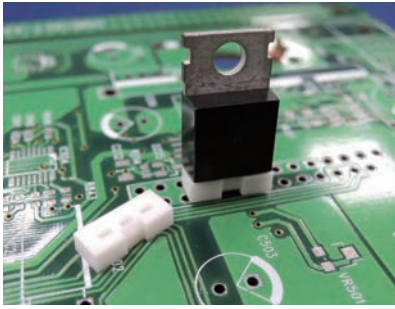

- Material: Nylon 66 (UL)
- Flame Class: 94V-2/94V-0
- Color: Natural/Black
- Unit: mm

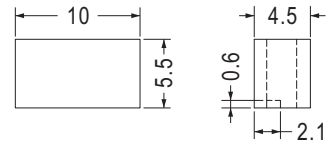
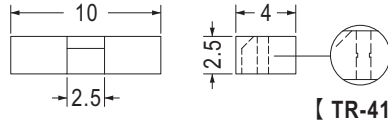
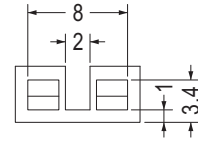
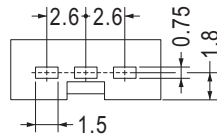

Part No.	Package
TR-32	1000
TR-41	

Part No.	Package
TR-43	1000

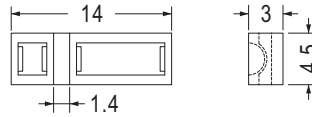
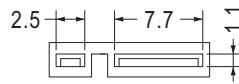
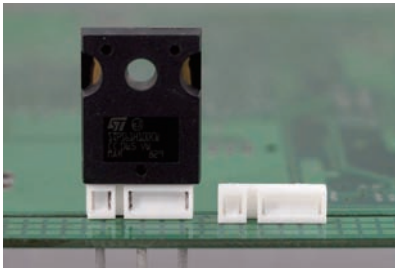

Part No.	Package
TRGC-4.5	1000

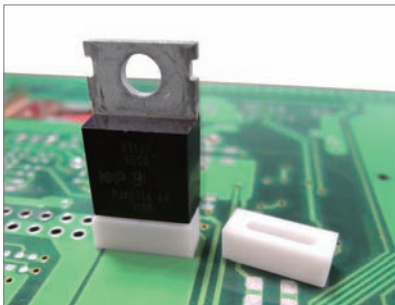

- Material: Nylon 66 (UL)
- Flame Class: 94V-2/94V-0
- Color: Natural/Black
- Unit: mm

用途：用於電晶體或零件之墊高與保護。

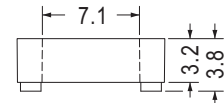
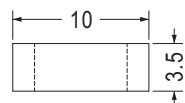
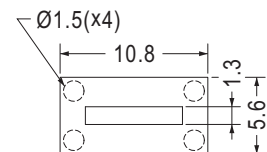
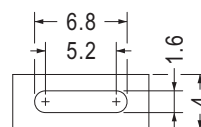

Part No.	Package
TR-33	1000

Part No.	Package
TR-42	1000

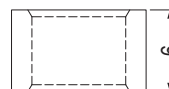
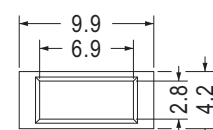
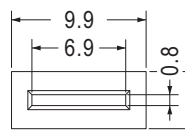

Part No.	Package
SUMA-6	1000

Part No.	Package
SUM-6	1000

## 電晶體座 TRANSISTOR HOUSING

用途：用於功率晶體之絕緣與防塵。

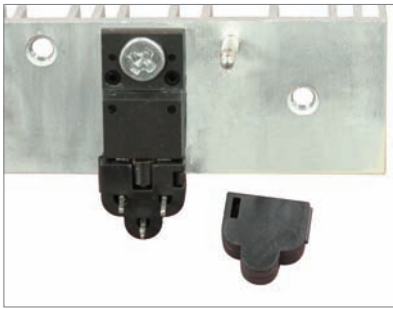

- Material: Nylon 66 (UL)
- Flame Class: 94V-2/94V-0
- Color: Natural/Black
- Unit: mm

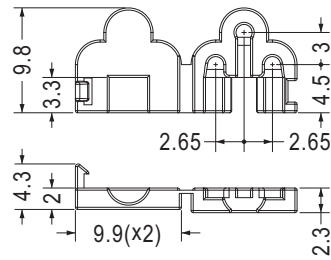

Part No.	Package
TRGB-1	1000

## 橋式整流座 BRIDGE RECTIFIER HOUSING

用途：保護橋式整流器立於PC板上使接腳不彎曲、折斷、短路且高度一致。

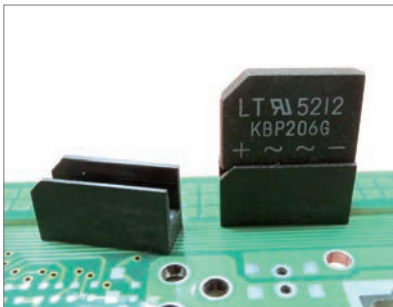

- Material: PBT (UL)
- Flame Class: 94V-0
- Color: Natural/ Black
- Unit: mm

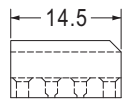
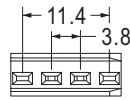

Part No.	Package
BGCV-15	500

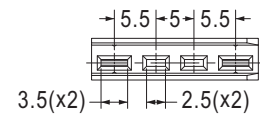

Part No.	Package
★BGCV-22S	500

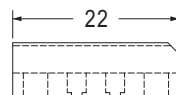
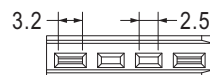
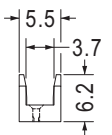

Part No.	Package
BGCV-22	500

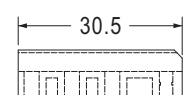
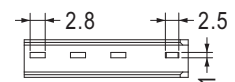

Part No.	Package
BGCV-30	500

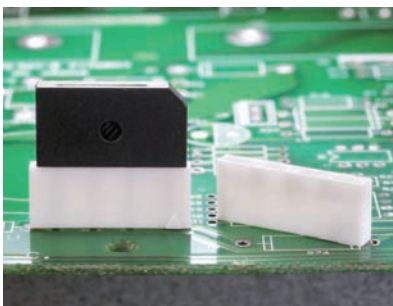
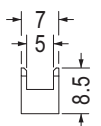

- Material: Nylon 66 (UL)
- Flame Class: 94V-2/94V-0
- Color: Natural/Black
- Unit: mm
- Patented (專利品)

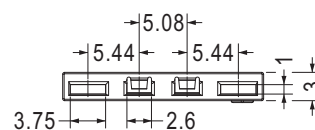

Part No.	Package
BGC-8.5	1000

# 橋式整流座 BRIDGE RECTIFIER HOUSING

用途：保護橋式整流器立於PC板上使接腳不彎曲、折斷、短路且高度一致。



- Material: Nylon 66 (UL)
- Flame Class: 94V-2/94V-0
- Color: Natural/Black
- Unit: mm

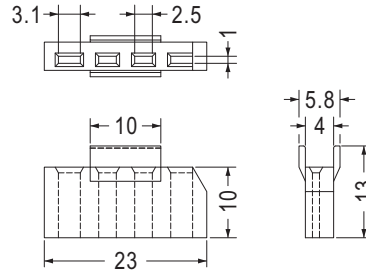

Part No.	Package
BGCV-23	500

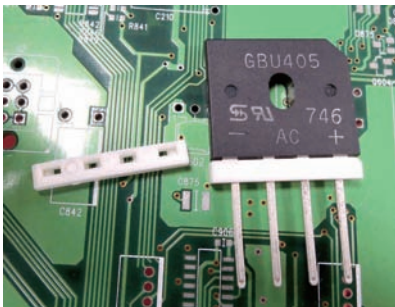

- Material: PBT (UL)
- Flame Class: 94V-0
- Color: Natural
- Unit: mm

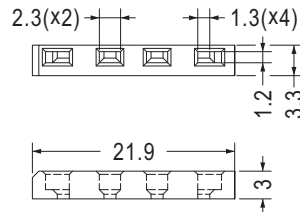

Part No.	Package
BGCA-22	1000

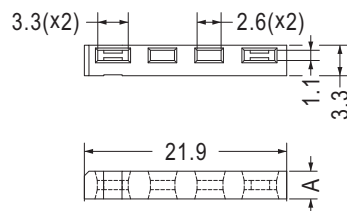
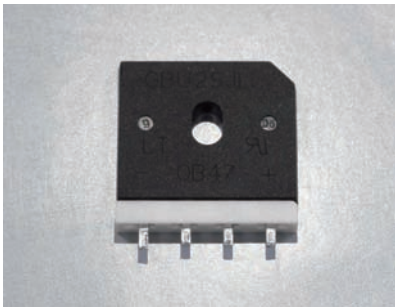

Part No.	A	Package
BGCC-22	3.0	1000
BGCC-22-5	5.0	

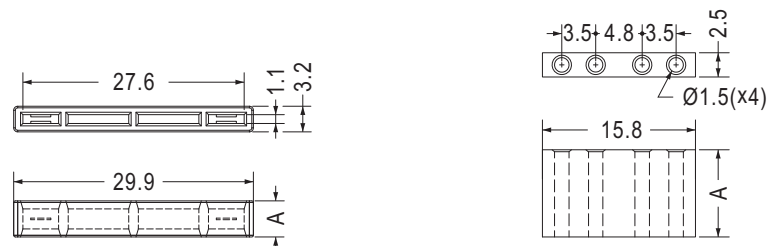
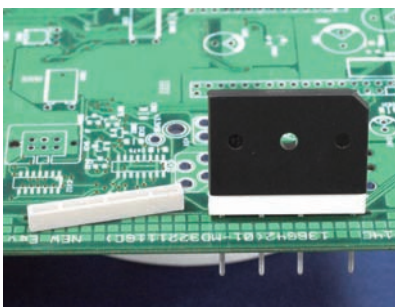

- Color: White

Part No.	A	Package
BGCB-30	4.5	1000
BGCB-30-8.5	8.5	

- Color: Black

Part No.	A	Package
BWC-1	9.0	1000
BWC-2	18.0	

## 霍爾晶體座 HALL EFFECT SENSOR HOUSING

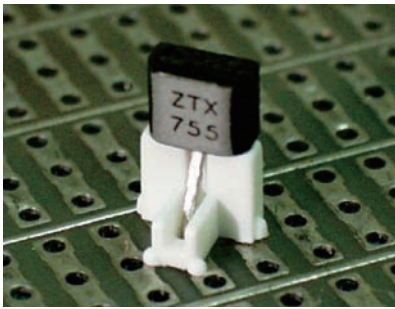

- Material: Nylon 66 (UL)
- Flame Class: 94V-2/94V-0
- Color: Natural/Black
- Unit: mm

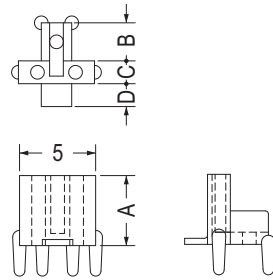

用途：保護霍爾晶體立於PC板上，使接腳不彎曲、折斷、短路且高度一致。

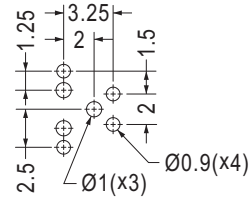

MOUNTING HOLE

Part No.	A	B	C	D	Package
HLS-1	4.6	2.5	1.5	1.5	2000
HLS-2	10.5	2.4	1.7	1.4	

## 可變電阻蓋 VARIABLE RESISTOR COVER



- Material: Nylon 66 (UL)
- Flame Class: 94V-2/94V-0
- Color: Natural/Black
- Unit: mm

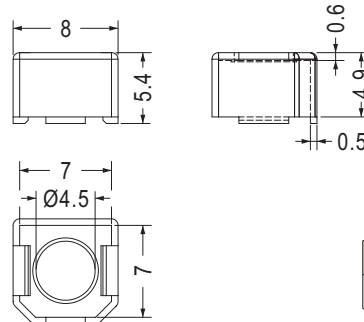

用途：可變電阻調整好，避免誤觸。

Part No.	Package
VRCV-1	2000

## 熱敏電阻座 THERMISTOR HOLDER



- Material: Nylon 66 (UL)
- Flame Class: 94V-2/94V-0
- Color: Natural/Black
- Unit: mm

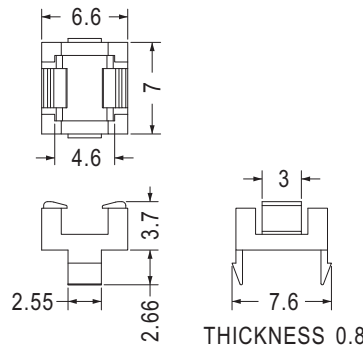

用途：用於熱敏電阻接腳之固定與保護。

Part No.	Package
TRE-1-1	2000

## IR晶體座 IR RECEIVER HOLDER



- Material: Nylon 66 (UL)
- Flame Class: 94V-2/94V-0
- Color: Natural/Black
- Unit: mm

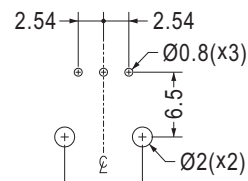
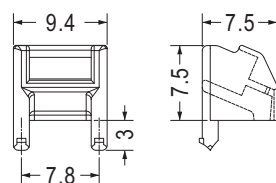

用途：保護IR晶體立於PC板上，使接腳不彎曲、折斷、短路，且高度一致。

MOUNTING HOLE THICKNESS 1.6

Part No.	Package
RECD-3	1000

# IR 晶體座 IR RECEIVER HOLDER

用途：保護IR晶體立於PC板上，使接腳不彎曲、折斷、短路，且高度一致。

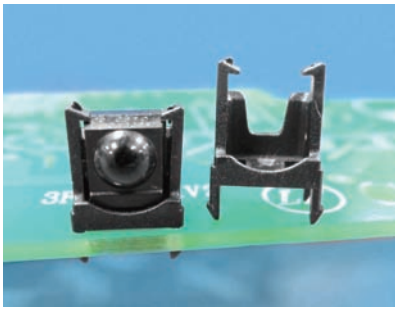

- Material: Nylon 66 (UL)
- Flame Class: 94V-2/94V-0
- Color: Natural/Black
- Unit: mm
- Patented (專利品)

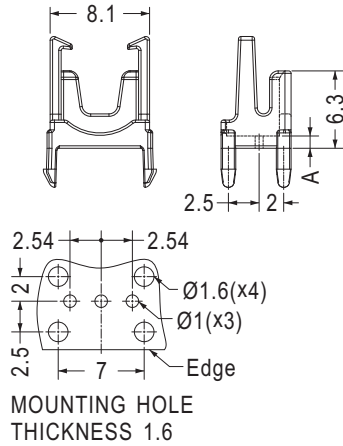

Part No.	A	Package
RECA-1	1.0	1000
RECA-1.5	1.5	
RECA-2	2.0	
RECA-2.5	2.5	
RECA-3	3.0	
RECA-3.5	3.5	
RECA-4	4.0	
RECA-4.5	4.5	
RECA-5	5.0	
RECA-5.5	5.5	
RECA-6	6.0	

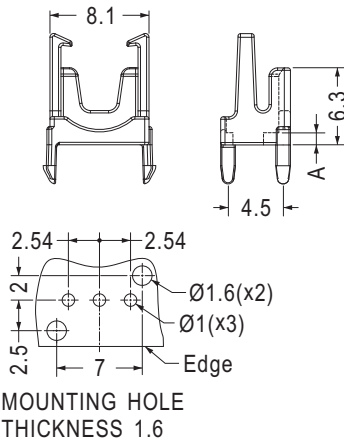

Part No.	A	Package
RECG-1	1.0	1000
RECG-1.5	1.5	
RECG-2	2.0	
RECG-2.5	2.5	
RECG-3	3.0	
RECG-3.5	3.5	
RECG-4	4.0	
RECG-4.5	4.5	
RECG-5	5.0	
RECG-5.5	5.5	
RECG-6	6.0	

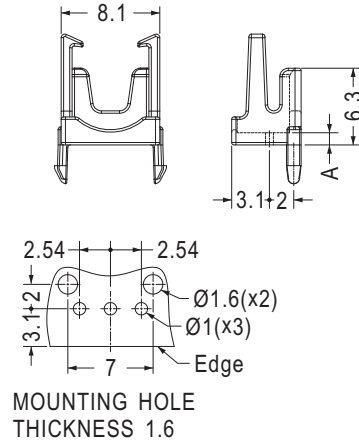

Part No.	A	Package
RECC-1	1.0	1000
RECC-1.5	1.5	
RECC-2	2.0	
RECC-2.5	2.5	
RECC-3	3.0	
RECC-3.5	3.5	
RECC-4	4.0	
RECC-4.5	4.5	
RECC-5	5.0	
RECC-5.5	5.5	
RECC-6	6.0	

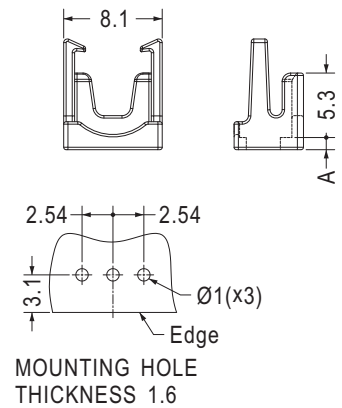

Part No.	A	Package
RECE-1	1.0	1000
RECE-1.5	1.5	
RECE-2	2.0	
RECE-2.5	2.5	
RECE-3	3.0	
RECE-3.5	3.5	
RECE-4	4.0	
RECE-4.5	4.5	
RECE-5	5.0	
RECE-5.5	5.5	
RECE-6	6.0	
RECE-7	7.0	

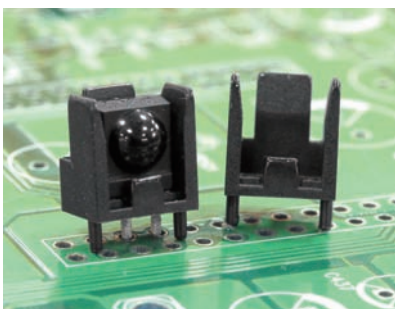

- Material: Nylon 66 (UL)
- Flame Class: 94V-2/94V-0
- Color: Natural/Black
- Unit: mm

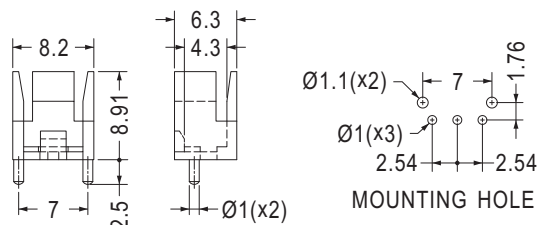

Part No.	Package
RECI-1	1000

# 電晶體座 IR TRANSISTOR HOUSING

用途：保護IR晶體立於PC板上，使接腳不彎曲、折斷、短路，且高度一致。



- Material: Nylon 66 (UL)
- Flame Class: 94V-2/94V-0
- Color: Natural/Black
- Unit: mm

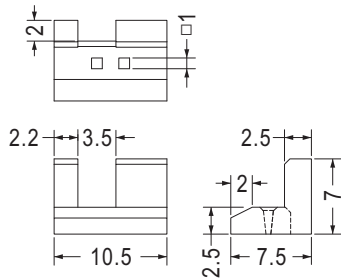

Part No.	Package
TR-46	1000

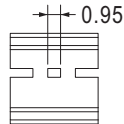

Part No.	Package
TRA-1	1000

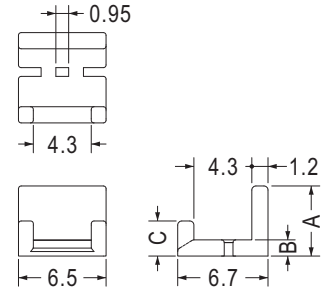
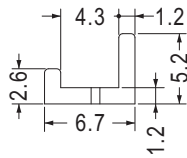

Part No.	A	B	C	Package
TRAC-1.2	5.2	1.2	2.6	1000
TRAC-2	6.0	2.0	3.4	
TRAC-5.3	9.3	5.3	6.7	

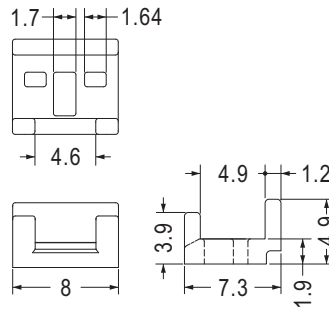

Part No.	Package
TRAD-0.9	1000

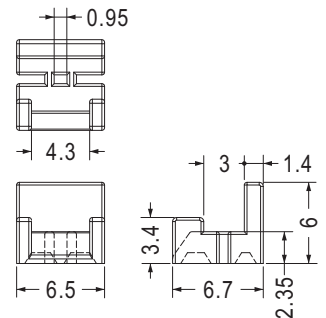

Part No.	Package
TRAE-2.35	1000

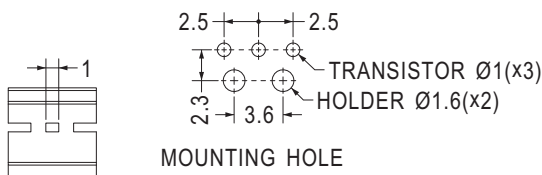

Part No.	Package
TRAB-1	1000

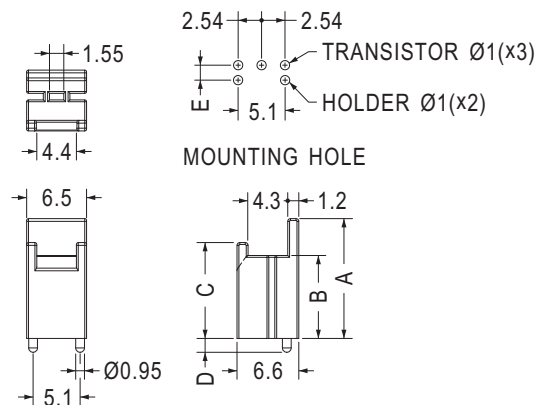

Part No.	A	B	C	D	E	Package
TRAC-9	13.0	9.0	10.4	1.5	1.6	1000
TRAC-10.8L	14.8	10.8	12.2	0.9	2.4	

# 光電晶體座 IR RECEIVER HOLDER

用途：用於光晶體腳座，固定高度可過錫爐，美觀整齊。

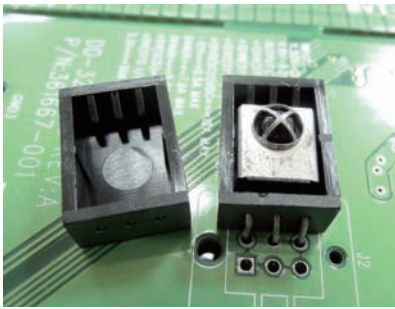

- Material: Nylon 66 (UL)
- Flame Class: 94V-2/94V-0
- Color: Natural/Black
- Unit: mm

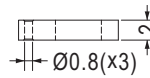
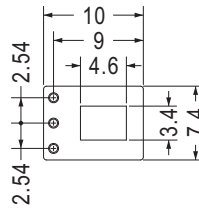

Part No.	Package
RCEA-2	1000

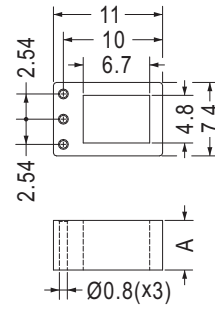

Part No.	A	Package
RCEA-3	3.0	1000
RCEA-5	5.0	
RCEA-6	6.0	
RCEA-12.6	12.6	

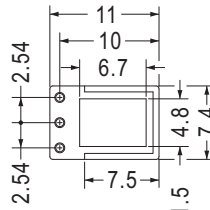
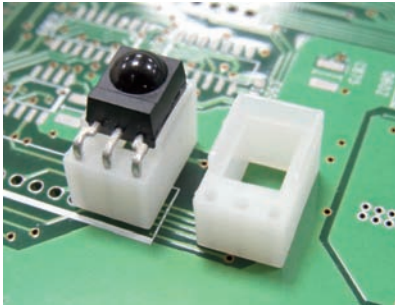

Part No.	Package
RCEA-10	1000

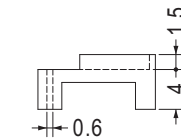
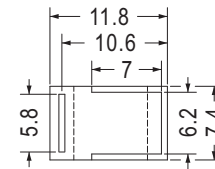

Part No.	Package
RCEA-4	1000

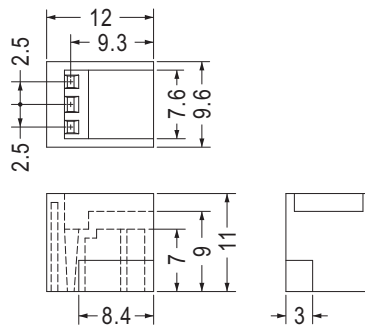

Part No.	Package
RCEA-9	1000

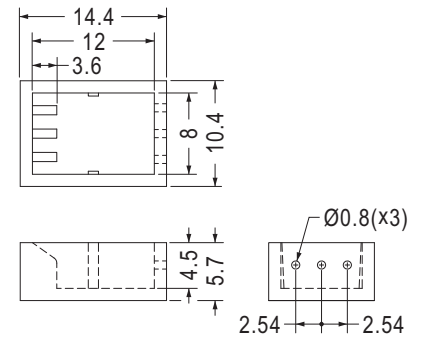

Part No.	Package
RCEC-2	1000

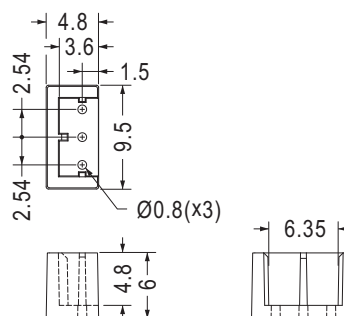

Part No.	Package
RCEF-1	1000

# 光電晶體座 IR RECEIVER HOLDER

用途：用於光晶體腳座，固定高度可過錫爐，美觀整齊。

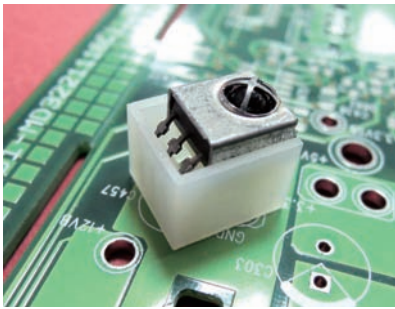

- Material: Nylon 66 (UL)
- Flame Class: 94V-2/94V-0
- Color: Natural/Black
- Unit: mm

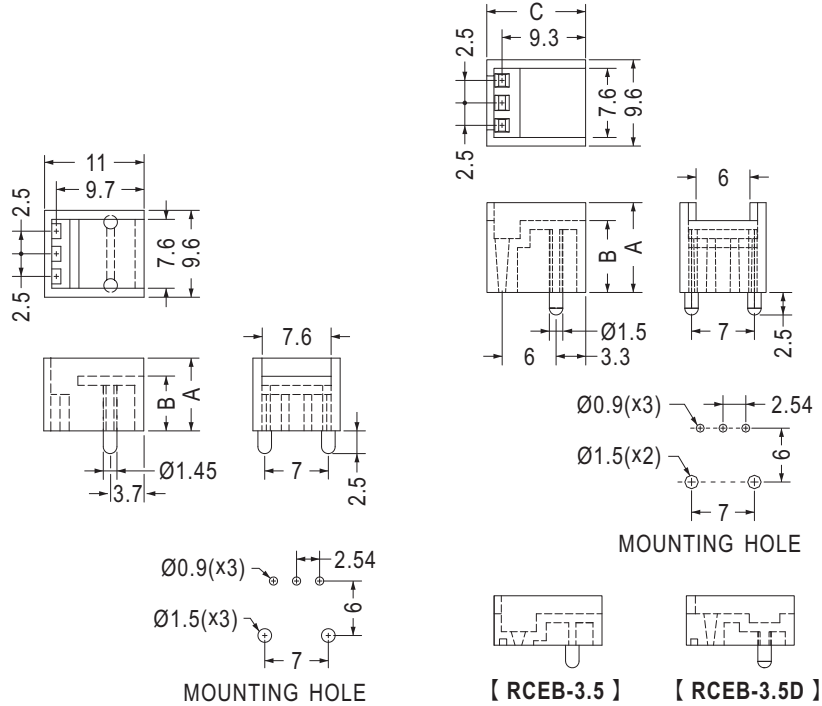
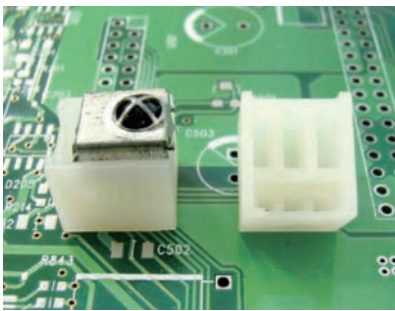
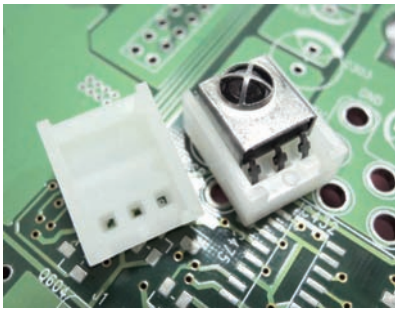

Part No.	A	B	Package
RCEB-4.5	6.5	4.5	1000
RCEB-6	8.0	6.0	

Part No.	A	B	C	Package
RCEB-3.5	5.5	3.5	12.0	1000
RCEB-3.5D	5.5	3.5	12.0	
RCEB-8	10.0	8.0	11.0	
RCEB-9	11.0	9.0	11.0	
RCEB-10.5	12.5	10.5	11.0	

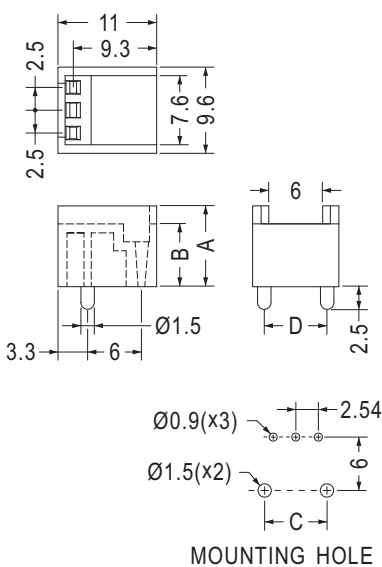

Part No.	A	B	D	Package
RCEB-7	9.0	7.0	7.0	1000
RCEB-15	17.0	15.0	6.0	

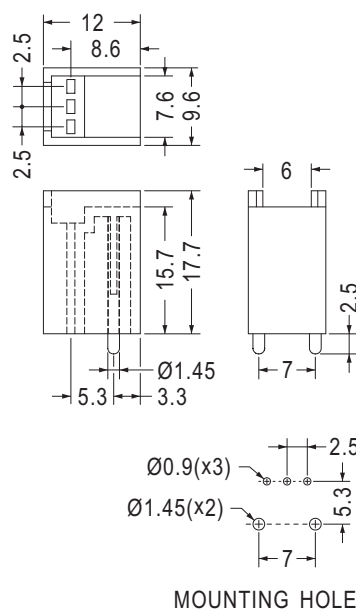

Part No.	Package
RCEB-15.7	1000

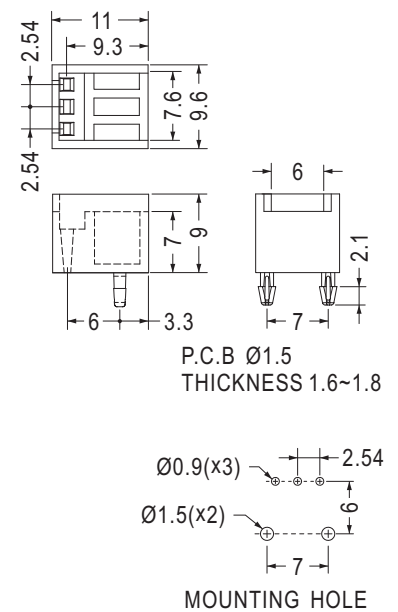

Part No.	Package
RCEE-7	1000

## 光電晶體座 IR RECEIVER HOLDER

用途：用於光晶體腳座，固定高度可過錫爐，美觀整齊。

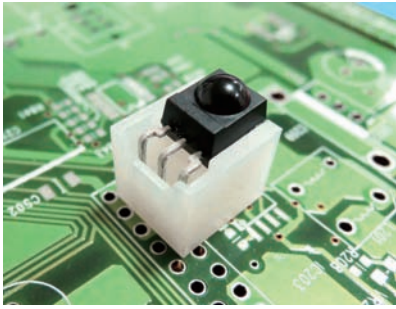

- Material: Nylon 66 (UL)
- Flame Class: 94V-2/94V-0
- Color: Natural/Black
- Unit: mm

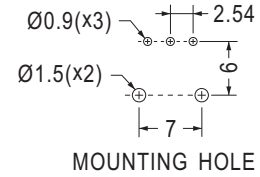
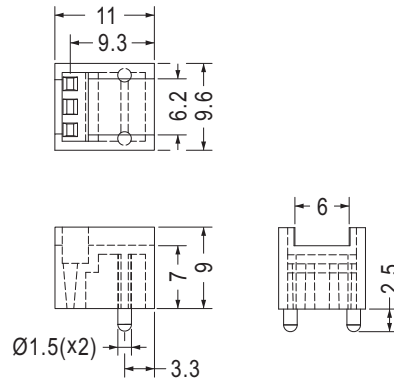

Part No.	Package
RCEH-1	1000

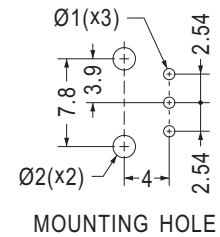
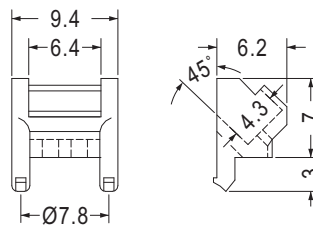

Part No.	Package
RECD-1	2000

## 光纖晶體座 OPTICAL LENS HOLDER

用途：光纖晶體焊於PC板上，高度一致，有定位腳，不傾斜，可與OPC-1配合使用。



- Material: Nylon 66 (UL)
- Flame Class: 94HB
- Color: Black
- Unit: mm

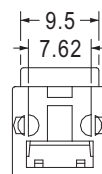
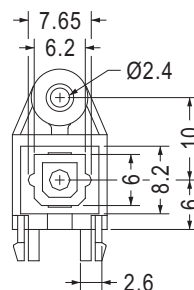

Part No.	Package
PLT130T	1000

## 墊片 WASHER

用途：用於電源插座接點間之絕緣。

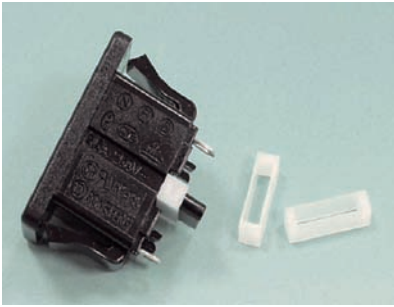

- Material: Nylon 66 (UL)
- Flame Class: 94V-2/94V-0
- Color: Natural/Black
- Unit: mm

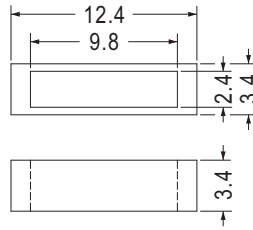

Part No.	Package
SQCP-3.4	2000

## 零件墊座 PARTS HOUSING

用途：用於零件之墊高。

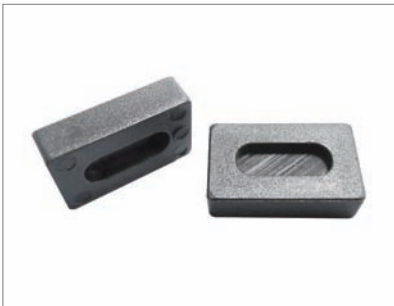

- Material: Nylon 66 (UL)
- Flame Class: 94V-2/94V-0
- Color: Natural/Black
- Unit: mm

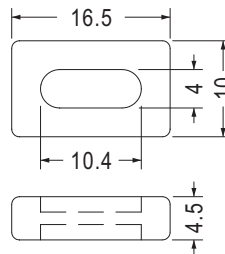

Part No.	Package
DVT-1	1000



- Material: PBT (UL)
- Flame Class: 94V-0
- Color: Natural
- Unit: mm

用途：做為零件之蓋片。

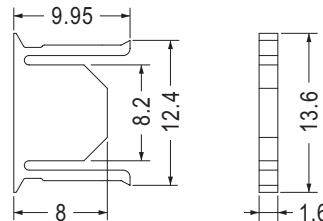

Part No.	Package
WPBT-1	1000

## 跳線座 JUMPER HOUSING

用途：立於PC板上，將兩跳線做隔離與保護固定用。

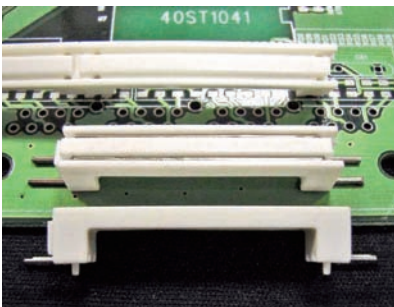

- Material: PBT (UL)
- Flame Class: 94V-0
- Color: Natural
- Unit: mm

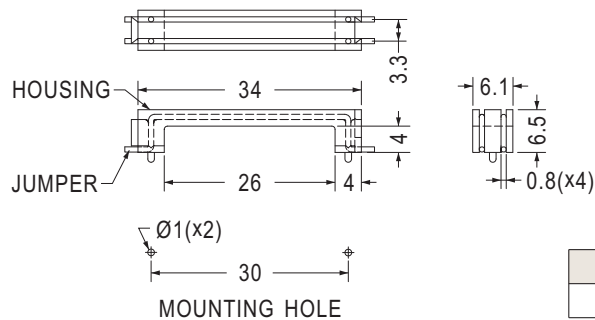

Part No.	Package
JPC-1	1000

## 墊片 WASHER

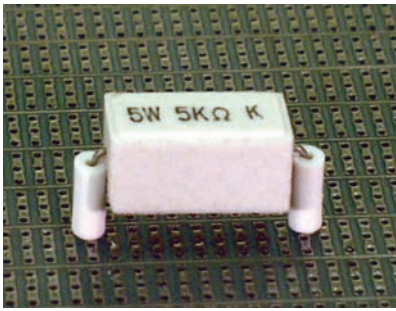

- Material: PBT (UL)
- Flame Class: 94V-0
- Color: Natural
- Unit: mm

用途：用於零件，如高瓦特數電阻接腳之墊高，避免熱氣積存於PC板上。

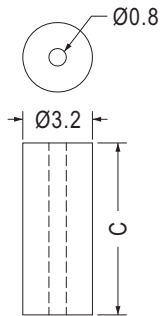

- Material: Nylon 6 (UL)
- Flame Class: 94V-2/94V-0

Part No.	C	Package
PW-14	7.9	1000
PW-16	1.5	2000

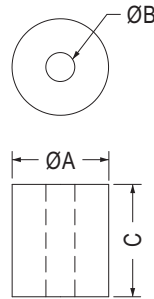

Part No.	A	B	C	Package
PW-1	4.0	1.4	4.2	2000
PW-1A	4.5	1.8	4.2	
PW-2	4.0	1.4	8.0	1000
PW-3	4.0	1.3	3.0	2000
PW-4	3.5	1.3	3.6	
PW-5	5.0	2.0	2.0	
PW-6	3.2	1.4	2.5	
PW-7	3.2	1.4	1.0	
PW-8	2.4	1.3	3.1	1000
PW-9	4.4	1.6	7.0	2000
PW-10	2.5	1.25	5.0	
PW-11	2.2	0.8	5.0	
PW-12	2.8	1.3	1.8	
PW-13	2.5	1.1	2.5	1000
PW-15	2.2	0.9	10.5	

## 陶瓷零件墊片 CERAMIC PARTS WASHER

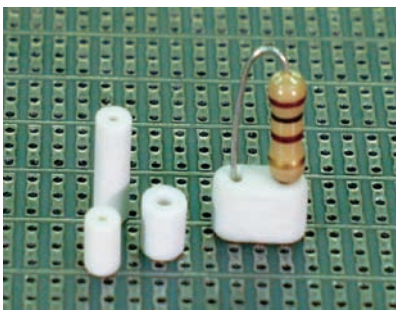

- Material: Ceramic
- Color: Natural/White
- Unit: mm

用途：用於零件，如高瓦特數電阻接腳之墊高，避免熱氣積存於PC板上。

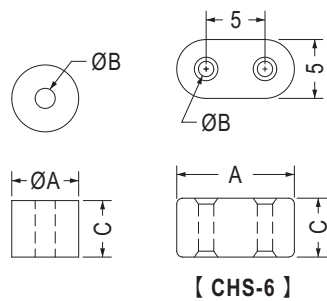

Part No.	A	B	C	Package
CHS-1	3.8	1.0	4.5	2000
CHS-2	3.8	1.0	9.0	
CHS-3	4.5	1.8	3.0	
CHS-4	4.5	1.8	4.5	
CHS-5	4.5	1.8	9.0	
CHS-6	10.0	1.3	5.0	
CHS-7	2.6	0.9	6.9	
CHS-8	2.5	1.1	3.1	1000
CHS-9	4.1	1.9	15.4	
CHS-10	4.1	1.9	13.0	
CHS-18	4.0	1.6	15.0	2000
CHS-19	4.5	1.8	2.0	

## 電阻保護座 ELECTRIC RESISTANCE HOLDER

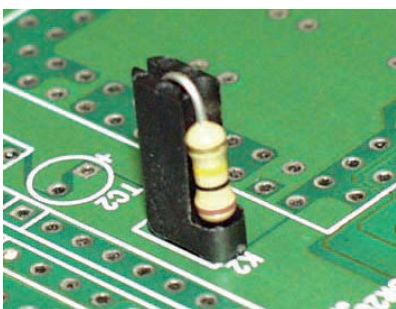

- Material: PPS (UL)
- Flame Class: 94V-0
- Color: Black
- Unit: mm

用途：用於電阻接腳之固定與保護。

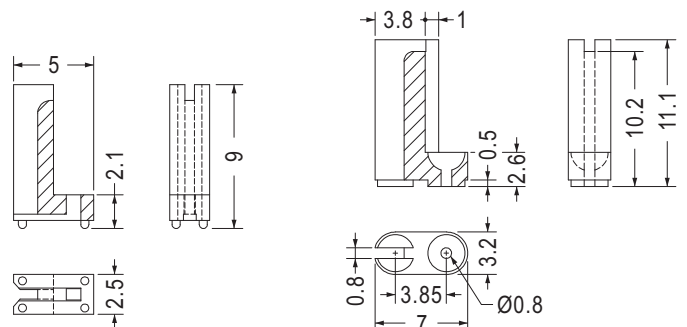

Part No.	Package
RPCL-9	2000

Part No.	Package
RPCL-11	2000

# 零件墊座 PARTS HOUSING

用途：用於電感器絕緣並保護。

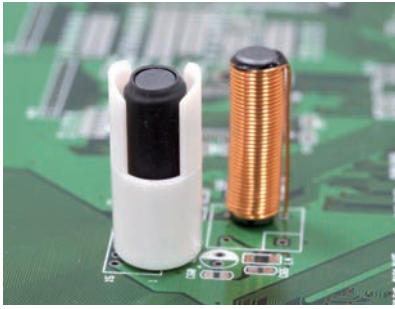

- Material: Nylon 66 (UL)
- Flame Class: 94V-2/94V-0
- Color: Natural/Black
- Unit: mm

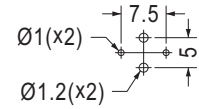
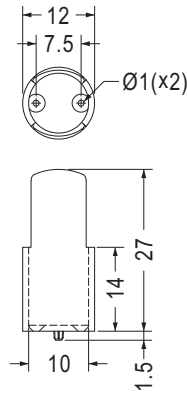

MOUNTING HOLE THICKNESS 1.6

Part No.	Package
PHC-14	500

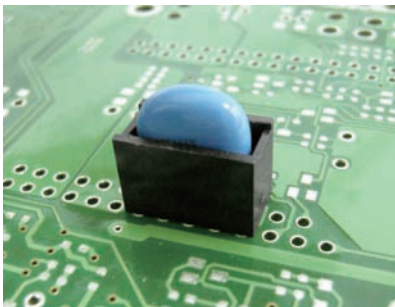

- Material: PPS (UL)
- Flame Class: 94V-0
- Color: Black
- Unit: mm

用途：用於零件之墊座。

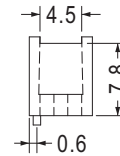
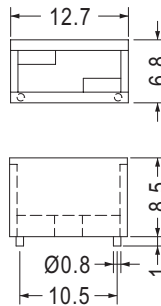

Part No.	Package
PH-26	1000

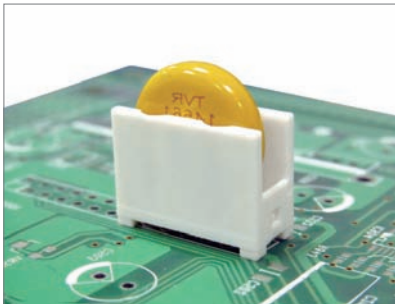

- Material: PBT (UL)/PPS (UL)
- Flame Class: 94V-0
- Color: Natural/Black
- Unit: mm

用途：用於零件接腳之墊高與保護。

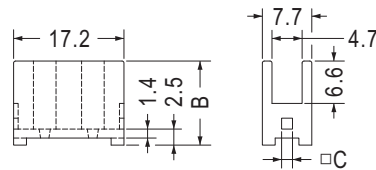
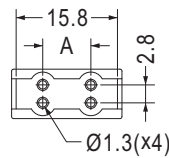

Part No.	A	B	C	Package
PHC-2	7.5	13.1		500
PHC-11	7.2	14.5		
PHC-12	7.5	13.1	1.7	



- Material: PBT (UL)
- Flame Class: 94V-0
- Color: Natural
- Unit: mm

- Material: Nylon 66 (UL)
- Flame Class: 94V-2/94V-0
- Color: Natural/Black
- Unit: mm

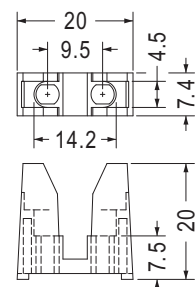
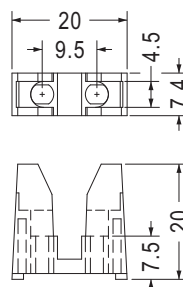

Part No.	Package
PHC-1	500

Part No.	Package
PHC8NNHA	1000

## 零件墊座 PARTS HOUSING

用途：用於零件之墊座。

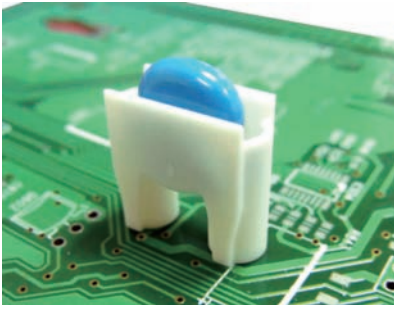

- Material: Nylon 66 (UL)
- Flame Class: 94V-2/94V-0
- Color: Natural/Black
- Unit: mm

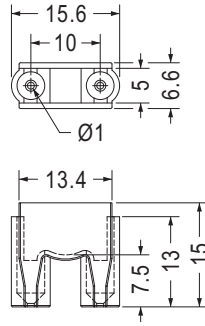

Part No.	Package
PHC-13	500

## 線圈座 PARTS HOUSING

用途：用於零件接腳之墊高與保護。

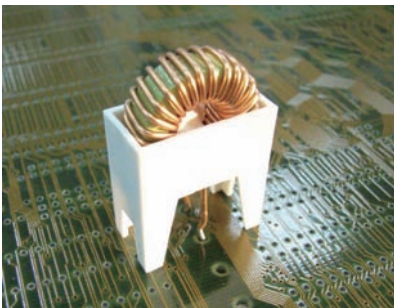

- Material: PBT (UL)
- Flame Class: 94V-0
- Color: Natural
- Unit: mm

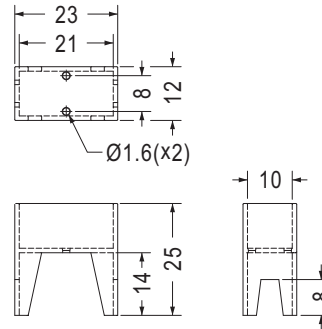

Part No.	Package
COILC-21	500

## 濾波器墊片 ELECTRIC FILTER WASHER

用途：用於濾波器絕緣，立於PC板上，且高度一致增加可靠度。

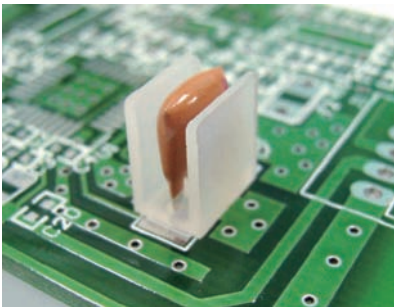

- Material: Nylon 66 (UL)
- Flame Class: 94V-2/94V-0
- Color: Natural/Black
- Unit: mm

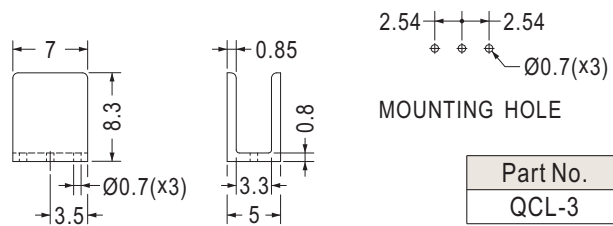

Part No.	Package
QCL-3	2000

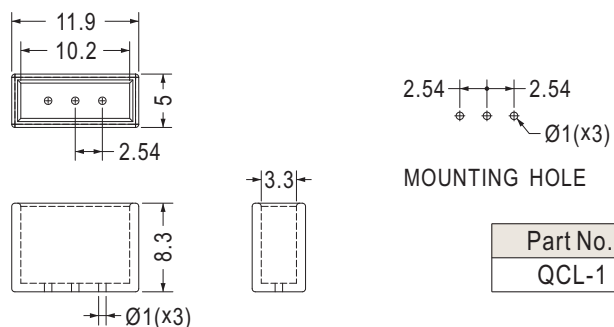

Part No.	Package
QCL-1	1000

## 電容器墊片 CAPACITOR WASHER

用途：用於電容器接腳保護。



- Material: Nylon 66 (UL)
- Flame Class: 94V-2/94V-0
- Color: Natural/Black
- Unit: mm

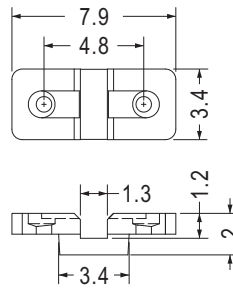

Part No.	Package
CWT-11	2000

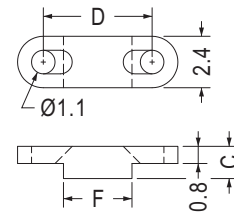

Part No.	C	D	F	Package
CWT-5	1.5	5.08	3.2	2000
CWT-8	1.2	7.6	4.0	
CWT-10	1.2	10.1	5.0	

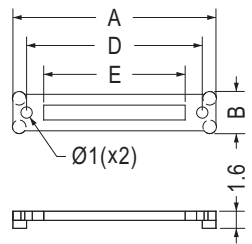

Part No.	A	B	D	E	Package
CWL-15	17.8	3.7	15.5	12.4	2000
CWL-22	25.0	7.0	22.5	17.0	1000

## 石英晶體墊片 CRYSTAL WASHER

用途：保護石英震盪晶體立於PC板上外殼不會與PC板短路，且高度一致增加可靠度。

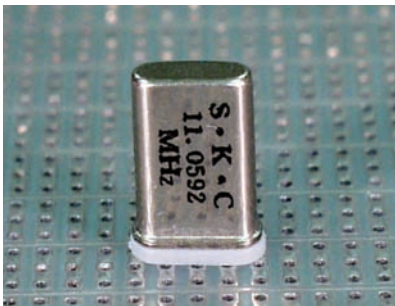

- Material: Nylon 66 (UL)
- Flame Class: 94V-2/94V-0
- Color: Natural/Black
- Unit: mm

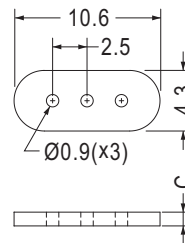

Part No.	C	Package
QW-1	1.0	2000
QW-5	0.5	

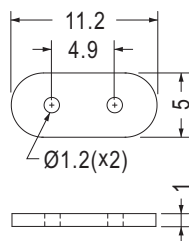

Part No.	Package
QW-3	2000

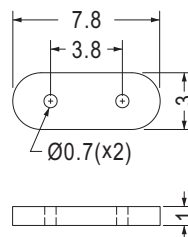

Part No.	Package
QW-6	2000

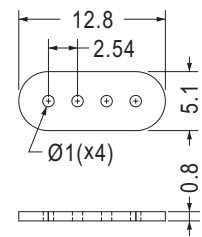

Part No.	Package
QW-8	2000

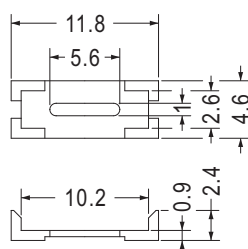

Part No.	Package
QW-2	2000

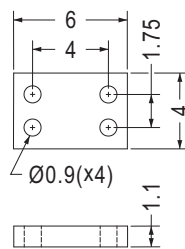

Part No.	Package
QW-7	2000

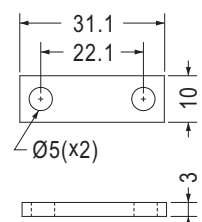

Part No.	Package
SWS311030	1000

## 石英晶體墊片 CRYSTAL WASHER

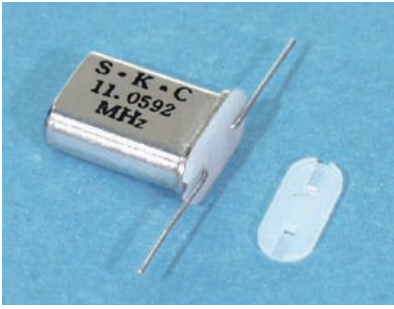

- Material: Nylon 66 (UL)
- Flame Class: 94V-2/94V-0
- Color: Natural/Black
- Unit: mm

用途：保護石英震盪晶體立於PC板上外殼不會與PC板短路，且高度一致增加可靠度。

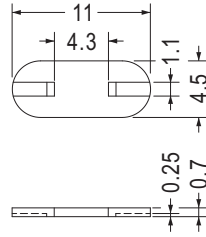

Part No.	Package
QW-4	2000

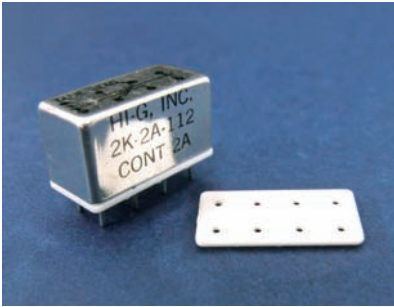

- Material: PBT (UL)
- Flame Class: 94V-0
- Color: Natural
- Unit: mm

用途：用於繼電器之墊高及保護。

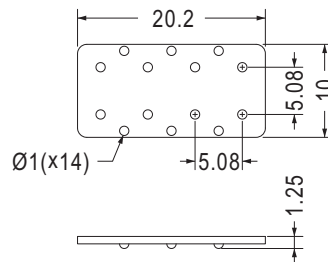

Part No.	Package
PAD-1	2000

## 電容器墊片 CAPACITOR WASHER

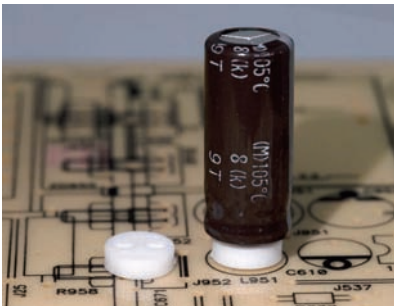

- Material: Nylon 66 (UL)
- Flame Class: 94V-2/94V-0
- Color: Natural/Black
- Unit: mm

用途：用於電容器之墊座。

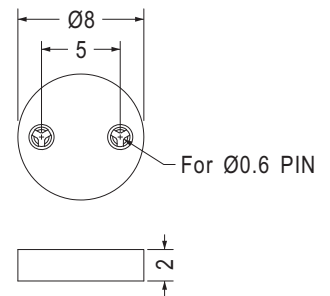
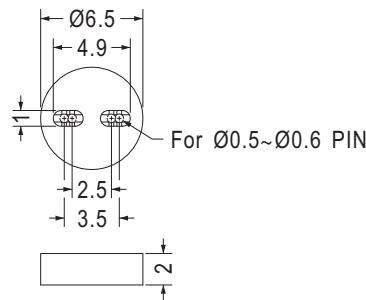

Part No.	Package
TRB-21	2000

Part No.	Package
TRB-22	2000

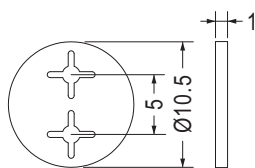
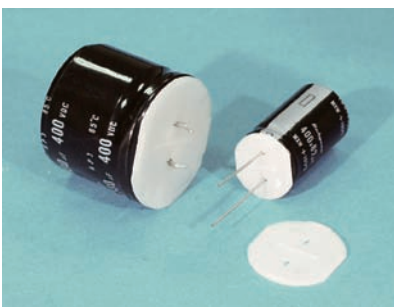

Part No.	Package
CW-10S	2000

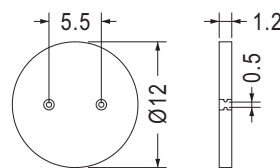

Part No.	Package
CW-12	1000

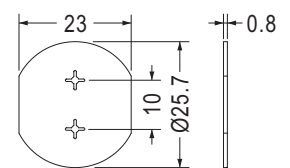

Part No.	Package
CW-25S	500

# 電容器墊片 CAPACITOR WASHER

用途：用於大電容器之墊座。



- Material: Nylon 66 (UL)
- Flame Class: 94V-2/94V-0
- Color: Natural/Black
- Unit: mm

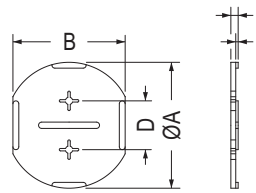

Part No.	A	B	C	D	E	Package
CW-16	16.2	14.6	1.5	7.5	0.5	1000
CW-18	18.2	16.4	1.5	7.5	0.5	
CW-22	22.2	20.0	1.5	10.0	0.5	
CW-25	25.7	23.0	1.5	10.0	0.5	500
CW-30	30.3	27.2	1.5	10.0	0.5	
CW-35	35.3	31.8	1.5	10.0	0.5	
CW-35L	35.3	31.8	2.0	10.0	1.0	

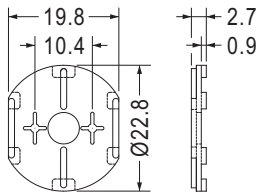

Part No.	Package
CW-1	500

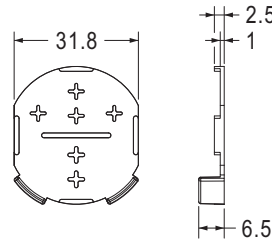

Part No.	Package
CW-2	500

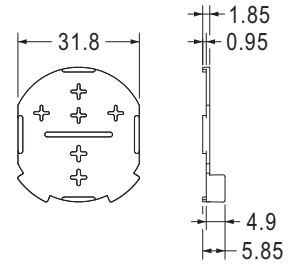

Part No.	Package
CW-3	500



- Material: Nylon 66 (UL)
- Flame Class: 94V-2/94V-0
- Color: Natural/Black
- Unit: mm

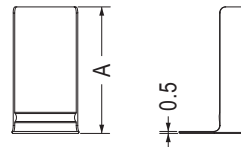
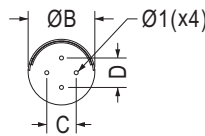

用途：用於電容器接腳保護。

Part No.	A	B	C	D	Package
CWCA-10	24.5	11.2	5.0	5.0	1000
CWCA-16	31.8	16.5	7.4	7.4	

6

# 電容器座 CAPACITOR HOUSING

用途：用於電容器接腳保護。



- Material: Nylon 66 (UL)
- Flame Class: 94V-2/94V-0
- Color: Natural/Black
- Unit: mm

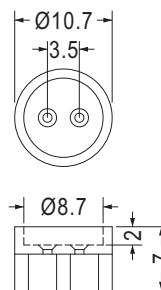

Part No.	Package
TRB-12	1000

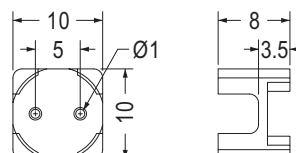

適用於 Ø10 的電容  
For Ø10 CAPACITOR

Part No.	Package
CAPL-3.5	1000

# 電容器座 CAPACITOR HOUSING

用途：用於電容器接腳保護。



- Material: Nylon 66 (UL)
- Flame Class: 94V-2/94V-0
- Color: Natural/Black
- Unit: mm

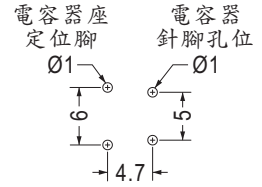
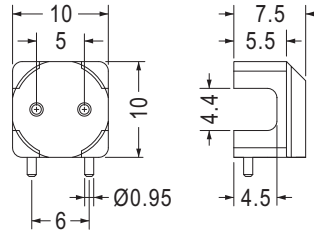

MOUNTING HOLE

Part No.	Package
CAPH-10	1000

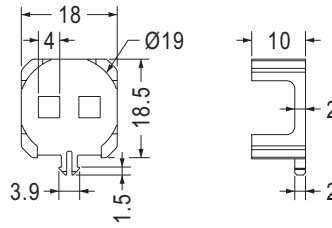
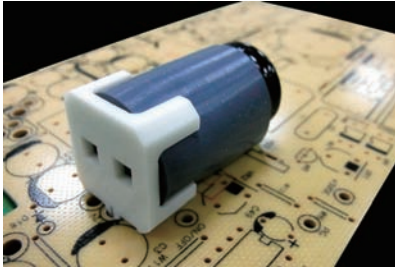

Part No.	Package
CAPI-18	500

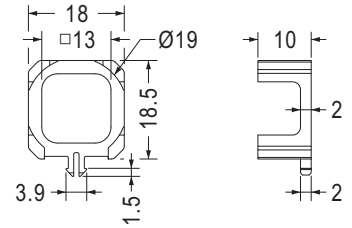

Part No.	Package
CAPJ-18	1000

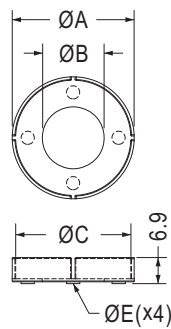
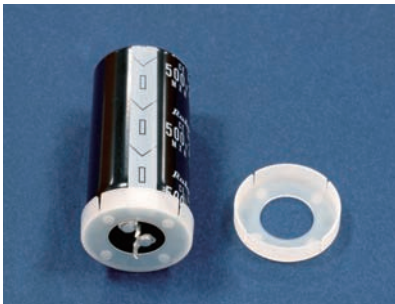

Part No.	A	B	C	E	Package
CWCD-2	27.3	13.9	25.6	3.5	500
CWCD-3	32.3	16.4	30.5	3.5	
CWCD-4	37.3	16.4	35.8	3.5	
CWCD-5	18.3	8.9	16.6	2.7	
CWCD-6	20.3	8.9	18.6	2.7	
CWCD-7	12.3	6.4	10.6	2.5	1000

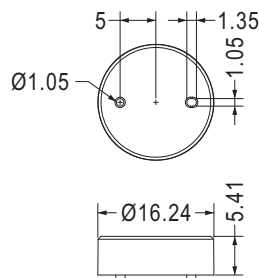

Part No.	Package
TRB-4	1000

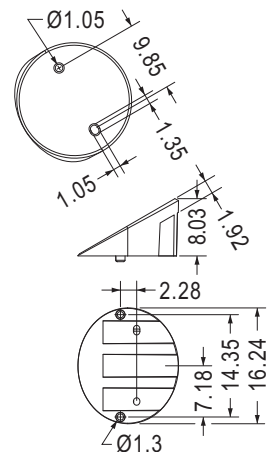

Part No.	Package
TRB-3	1000

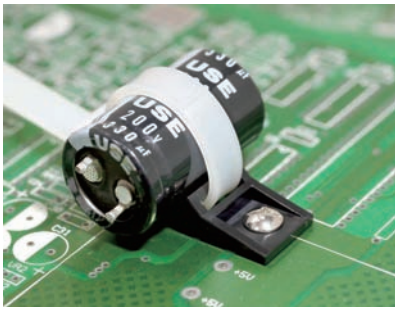

- Material: Nylon 66 (UL)
- Flame Class: 94V-2/94V-0
- Color: Natural/Black
- Unit: mm

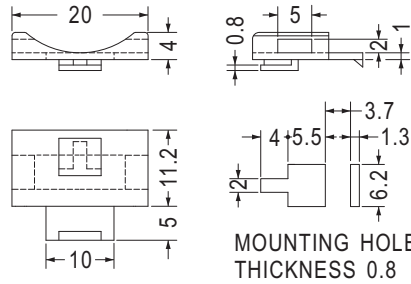

Part No.	Package
MTAC-1	500

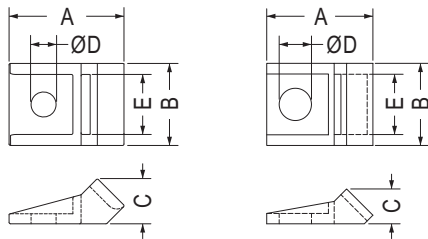

【 MTAB-4, MTAB-6 】 Mounting Screw Size

Part No.	A	B	C	D	E	Screw Size	Package
MTAB-4	19.0	11.3	8.0	4.2	8.3	M4	1000
MTAB-5	17.4	13.5	5.7	5.3	10.1	#10	
MTAB-6	23.0	16.4	9.04	5.2	12.0	M5	
MTAB-10	27.4	21.4	10.3	8.4	16.7	5/16	500

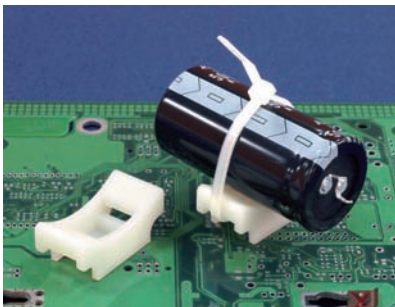

- Material: Nylon 66 (UL)
- Flame Class: 94V-2/94V-0
- Color: Natural/Black
- Unit: mm

用途：用於電容器接腳保護，配合束線帶固定使用。

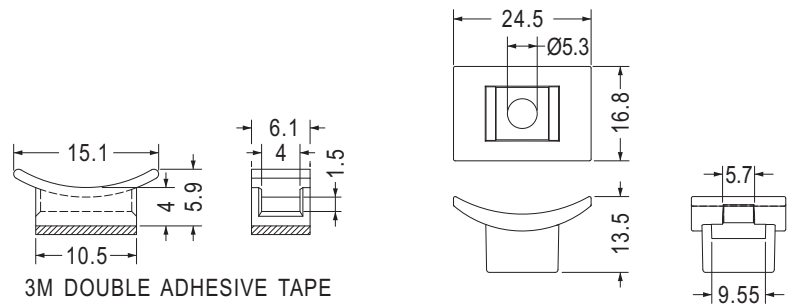

3M DOUBLE ADHESIVE TAPE

Part No.	Package
THMB-1	1000

Part No.	Package
THMB-2	1000

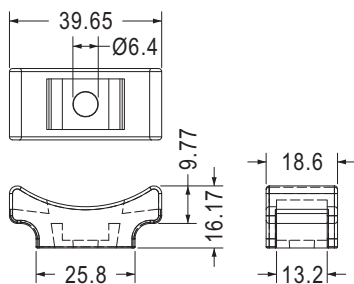

Part No.	Package
THMB-3	1000

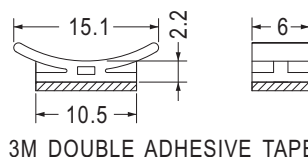

Part No.	Package
THMC-1	1000

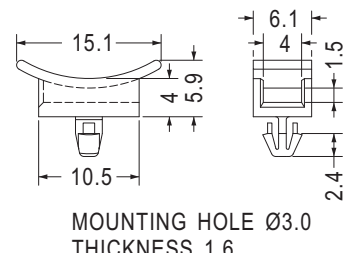

Part No.	Package
THMK-1	1000

## 電容器座 CAPACITOR HOUSING

用途：用於電容器固定。

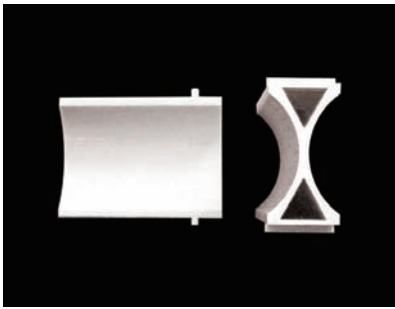

- Material: ABS (UL)
- Flame Class: 94HB
- Color: Gray
- Unit: mm

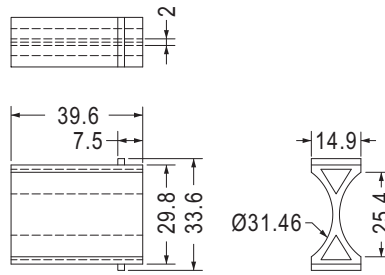

Part No.	Package
KYPC-40	250



- Material: Nylon 66 (UL)
- Flame Class: 94V-2/94V-0
- Color: Natural/Black
- Unit: mm

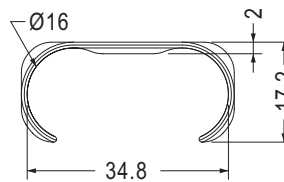

Part No.	Package
DELT-20	100

## 電容器固定座 CAPACITOR MOUNT

用途：固定電容器於機板上，維修方便，不佔空間。



- Material: Nylon 66 (UL)
- Flame Class: 94V-2/94V-0
- Color: Natural/Black
- Unit: mm

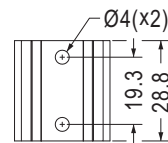
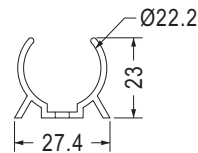

WALL THICKNESS 1.7

Part No.	Package
WLLC-1	250

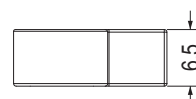
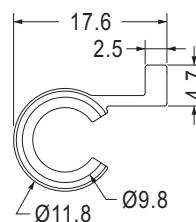

Part No.	Package
CWCK-10	1000

## 電容器固定座 CAPACITOR MOUNT

用途：固定電容器於機板上，維修方便，不佔空間。



- Material: Nylon 66 (UL)
- Flame Class: 94V-2/94V-0
- Color: Natural/Black
- Unit: mm

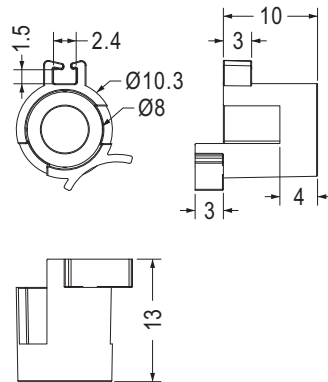

Part No.	Package
CWCF-8	1000

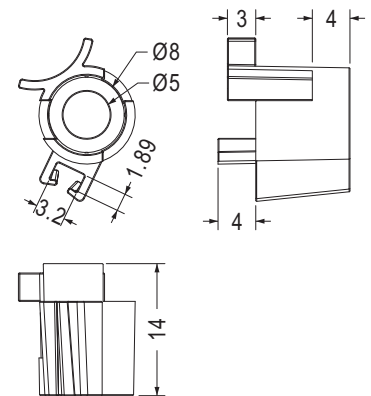

Part No.	Package
★CWCG-8	1000

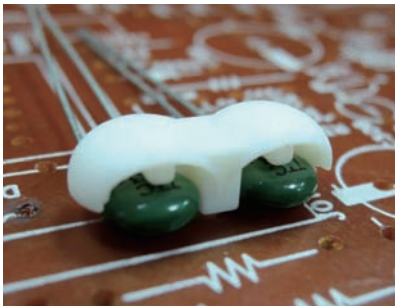

- Material: Nylon 66 (UL)
- Flame Class: 94V-2/94V-0
- Color: Natural/Black
- Unit: mm

用途：用於電容器固定。

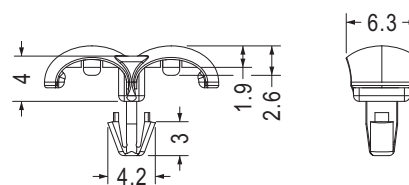

MOUNTING HOLE Ø3.0  
THICKNESS 1.5

Part No.	Package
CLDK-1	1000

## 電容器蓋 CAPACITOR COVER

用途：用於電容器之絕緣與保護。



- Material: Nylon 66 (UL)
- Flame Class: 94V-2/94V-0
- Color: Natural/Black
- Unit: mm

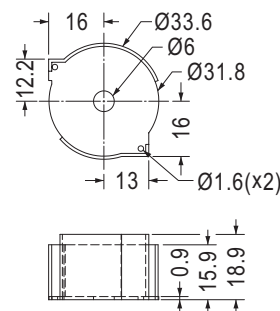

Part No.	Package
BASE-L5	1000

## 矽膠帽套 SILICON INSULATOR COVER

用途：用於電解電容之外殼絕緣，絕緣性特佳。



- Material: Silicon Rubber (UL)
- Flame Class: 94V-0
- Color: Black
- Unit: mm

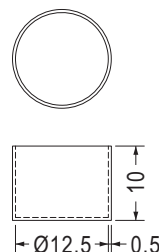

Part No.	Package
BCCA-1210	500

# 電容器蓋 CAPACITOR COVER

用途：用於電容器之絕緣與保護。



- Material: Nylon 66 (UL)
- Flame Class: 94V-2/94V-0
- Color: Natural/Black
- Unit: mm

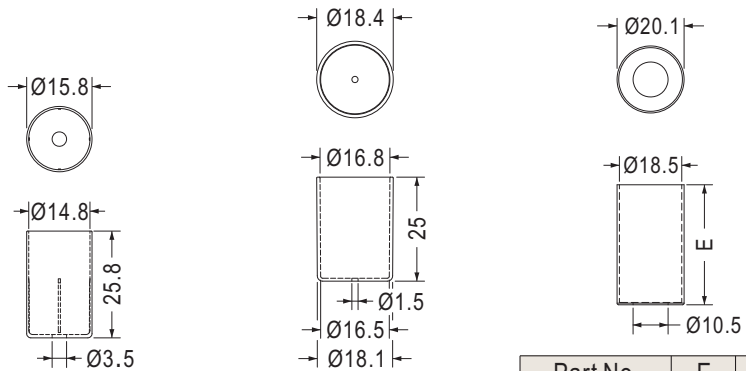

Part No.	Package
BCB-14.5	100

Part No.	Package
BCB-16	500

Part No.	E	Package
BCBA-18	40.5	200
BCBA-18-1	36.0	

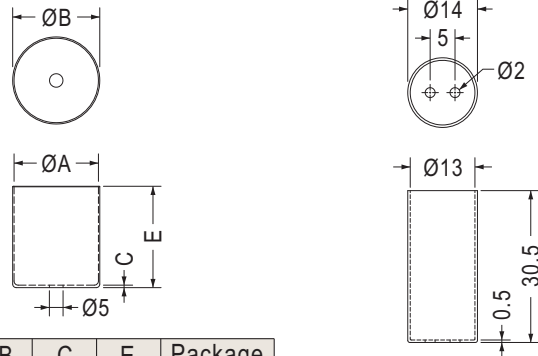

Part No.	A	B	C	E	Package
★BCB-12.7	12.8	13.7	0.45	20.0	100
BCB-30	30.8	31.8	0.9	37.0	

Part No.	Package
★BCB13-30	1000

# 電容器帽套 CAPACITOR COVER

用途：用於電解大電容器之絕緣與保護。



- Material: Nylon 66 (UL)
- Flame Class: 94V-2/94V-0
- Color: Natural/Black
- Unit: mm

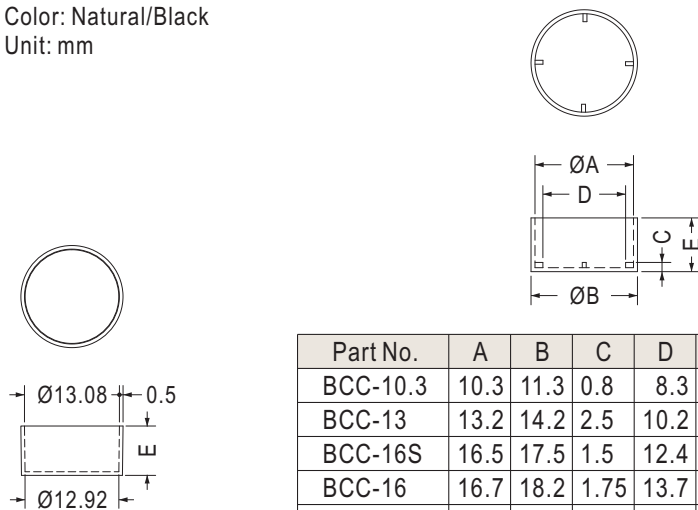

Part No.	E	Package
BCH13-6.8	6.8	1000
BCH13-13	13.0	

Part No.	A	B	C	D	E	Package
BCC-10.3	10.3	11.3	0.8	8.3	6.4	500
BCC-13	13.2	14.2	2.5	10.2	15.0	
BCC-16S	16.5	17.5	1.5	12.4	20.0	
BCC-16	16.7	18.2	1.75	13.7	10.2	
BCC-18	18.7	20.2	1.75	15.7	10.2	2000
BCC-22	22.2	23.4	1.05	18.0	8.0	
BCC-25	26.0	27.2	0.75	22.0	8.0	
BCC-27	27.0	28.2	1.05	23.0	15.0	

# 電容器帽套 CAPACITOR COVER

用途：用於電解大電容器之絕緣與保護。

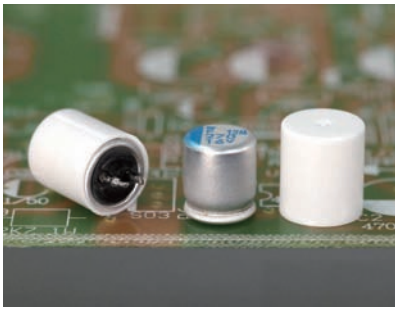

- Material: Nylon 66 (UL)
- Flame Class: 94V-2/94V-0
- Color: Natural/Black
- Unit: mm

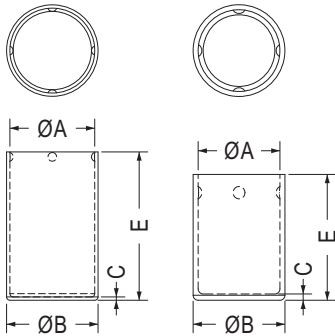

【 BCCA10.3-18 】

Part No.	A	B	C	E	Package
BCCA6.3-10	6.5	7.3	0.5	10.0	1000
BCCA6.3-12	6.5	7.3	0.4	12.0	
BCCA8-10	8.2	9.0	0.5	10.0	
BCCA8-13.4	8.2	9.0	0.4	13.4	
BCCA10.3-18	10.3	11.1	0.4	18.0	
★BCCA35-30	36.0	37.0	0.5	30.5	100

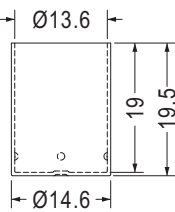
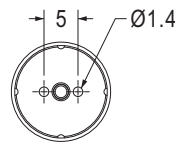
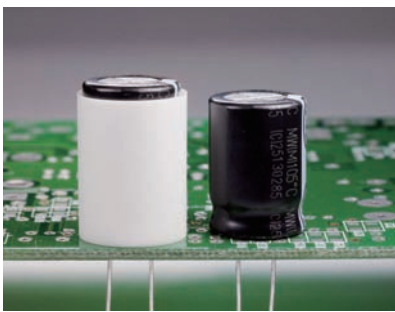

Part No.	Package
★BCB13-19	500

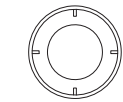
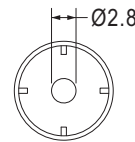

Part No.	Package
BCD-10.3	500

Part No.	Package
BCC-18-20	500

# 陶瓷零件墊片 CERAMIC PAD

用途：用於零件之絕緣散熱，散熱性佳。

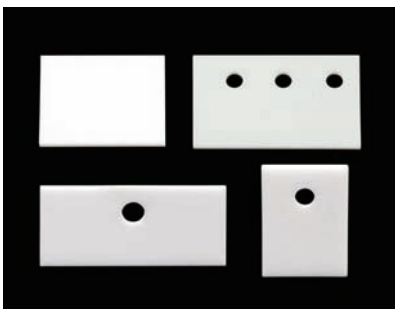

- Material: Ceramic
- Color: Natural
- Unit: mm

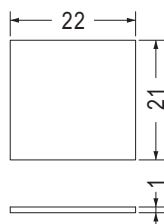

Part No.	Package
CHSA-1	100

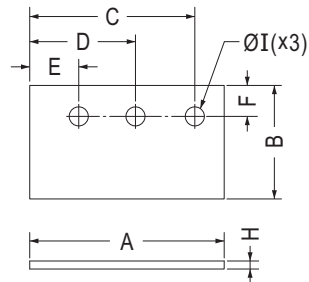

Part No.	A	B	C	D	E	F	H	I	Package
CHSA-2	37.7	22.0	32.0	20.5	9.5	6.0	1.55	3.7	50
CHSA-4	34.8	20.0	28.8	17.3	5.8	4.0	1.0	3.7	100
CHSA-5	42.0	20.0	33.8	20.2	6.0	4.0	1.0	3.7	50
CHSA-6	30.0	13.6	/	15.0	/	4.5	1.0	3.5	100
CHSA-7	16.0	21.0	/	8.0	/	5.9	2.5	3.5	

## 散熱陶瓷墊片 CERAMIC HEAT SINK

用途：用於零件之絕緣散熱，散熱性佳。

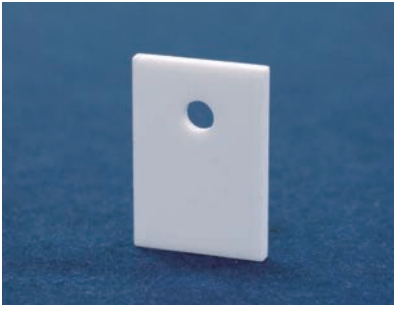

- Material: Ceramic
- Color: White
- Unit: mm

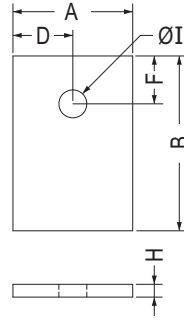

Part No.	A	B	D	F	H	I	Package
TO-3PAWO	15.0	21.9	7.5	6.0	1.6	3.5	200
TO-220AWO	13.7	19.0	6.85	5.0	2.0	3.8	100

## CPU散熱矽膠片 CPU THERMAL TRANSFER SILICON PAD

用途：CPU或手提電腦散熱用，可用背膠(單面或雙面)。



- Material: Silicon (UL)
- Flame Class: 94V-0
- Color: Gray
- Unit: mm
- Thickness: 0.5~4.0mm

尺寸可依客戶要求。  
Different size available per request.

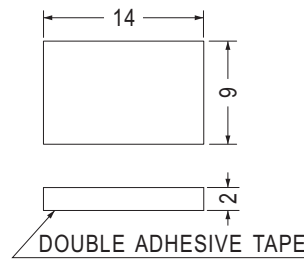

Part No.
CPU140920A

## 矽膠片 SILICON INSULATOR

用途：鎖於功率晶體與散熱片之間導熱、絕緣性特佳。

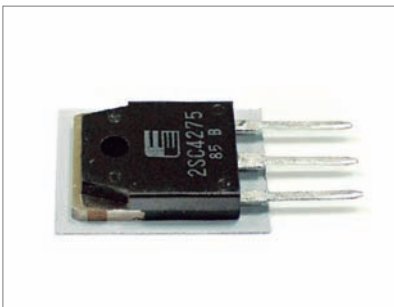

- Material: Silicon (UL)
- Flame Class: 94HB/94V-0
- Color: Gray
- Unit: mm

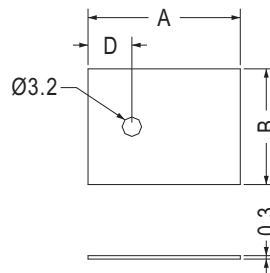

Part No.	A	B	D	Package
TO-3P	25.0	19.0	7.2	1000
TO-220	19.0	13.2	5.0	

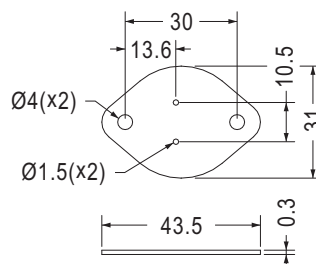

Part No.	Package
TO-3	1000

# 矽膠帽套 SILICON INSULATOR COVER

用途：固定於功率晶體與散熱片之間，絕緣性特佳。

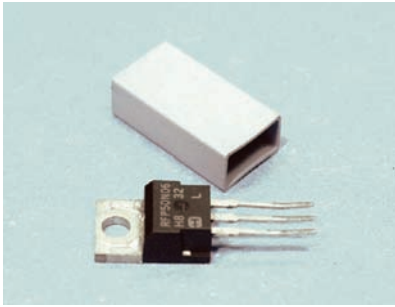

- Material: Silicon (UL)
- Flame Class: 94HB/94V-0
- Color: Gray
- Unit: mm

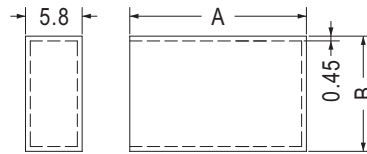

Part No.	A	B	Package
TO-3PCV	28.5	17.5	1000
TO-3PCV-C	25.0	17.5	
TO-220CV	21.7	11.5	

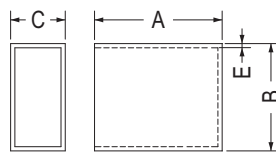

Part No.	A	B	C	E	Package
SRT-111158	11.0	11.5	5.8	0.45	2000
SRT-111758	16.0	11.4	5.5	0.45	1000
SRT-182864	28.5	18.0	6.4	0.75	
SRT-203464	35.0	20.0	6.4	0.75	

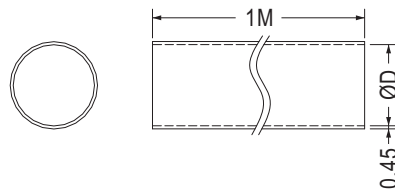
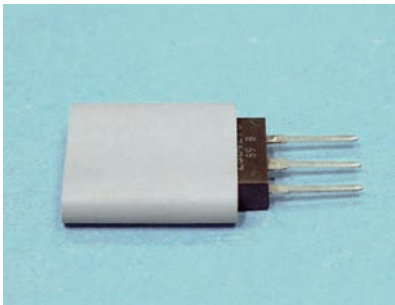

Part No.	D
SRT6	6.0
SRT8	8.0
SRT10	10.0
SRT12	12.0
SRT14	14.0
SRT16	16.0
SRT18	18.0

6



- Material: Silicon (UL)
- Flame Class: 94HB/94V-0
- Color: Gray
- Unit: mm

用途：用於大電解電容之外殼絕緣，絕緣性特佳。

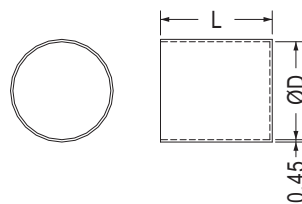

Part No.	D	L	Package
SCT-0726	7.8	26.0	1000
SCT-1315	13.0	15.0	
SCT-1615	16.7	15.0	
SCT-1825	18.5	25.0	500

## 電池蓋 BATTERY COVER

用途：用於電池蓋之防塵與保護。



- Material: Silicon Rubber (UL)
- Flame Class: 94V-0
- Color: Black
- Unit: mm

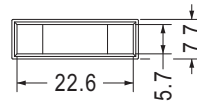
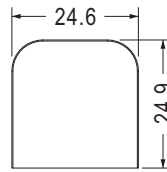

Part No.	Package
SRTA-1	1000

## 保險絲蓋 FUSE COVER

用途：用於保險絲之絕緣與防塵。



- Material: Soft P.V.C
- Color: Blue/Black
- Unit: mm

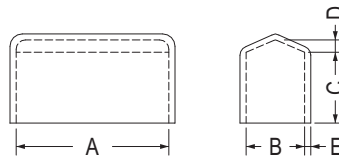

- 如需UL認可材質，請在料號尾碼加UL下單
- Please add UL after Part Number for UL certified material.

Part No.	A	B	C	D	E	Package
FH-1	20.0	6.0	11.0	1.0	1.2	1000
FH-1L	22.0	6.0	11.0	1.0	1.5	
FH-1S	18.0	5.3	9.0	1.0	1.0	
FH-3A	31.8	9.1	12.0	1.5	1.2	500
FH-3	31.8	9.5	13.0	1.5	1.3	
FH-4	41.0	12.8	19.0	2.0	1.2	
FHC-5	19.0	3.3	10.0	1.0	1.2	1000

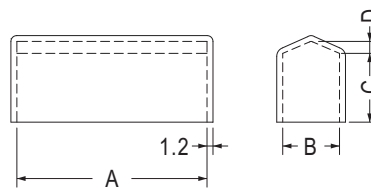
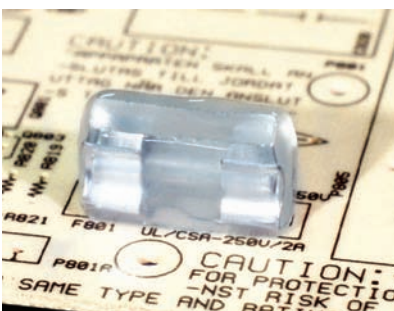

- Color: Natural

Part No.	A	B	C	D	Package
FUSE-1	20.0	6.0	11.0	1.0	1000
FUSE-2	31.8	9.5	13.0	1.5	500
FUSE-3	36.1	8.1	9.9	1.0	

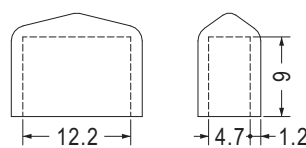

- Color: Black

Part No.	Package
FH-13	1000

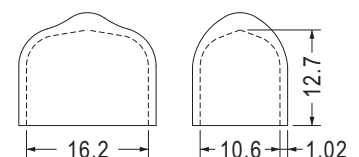

- Color: Blue

Part No.	Package
FH-17	1000

## 保險絲蓋 FUSE COVER

用途：用於SMT保險絲蓋之防塵與保護。



- Material: Nylon 66 (UL)
- Flame Class: 94V-2/94V-0
- Color: Natural/Black
- Unit: mm

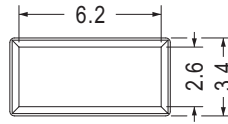
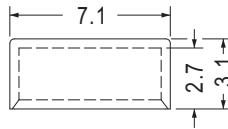

Part No.	Package
FUSEA-1	1000

## 電容器護套 CAPACITOR COVER

用途：用於電容器之絕緣與防塵。



- Material: Soft P.V.C
- Color: Natural
- Unit: mm

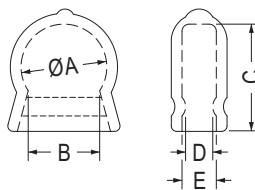

- 如需UL認可材質，請在料號尾碼加UL下單
- Please add UL after Part Number for UL certified material.

Part No.	A	B	C	D	E	Package
HU-8	8.5	7.5	10.0	3.0	3.0	1000
HU-10	10.5	9.0	12.3	3.0	4.0	
HU-12	12.0	10.0	15.0	3.8	4.8	

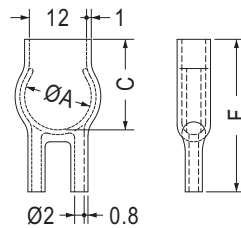
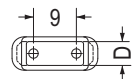

- 如需UL認可材質，請在料號尾碼加UL下單
- Please add UL after Part Number for UL certified material.

Part No.	A	C	D	F	Package
HU-14	14.0	16.0	4.0	22.0	1000
HU-16	16.0	19.0	5.0	32.0	

## 末端套管 VCP CAP

用途：用於連接器之絕緣與防塵。



- Material: Soft P.V.C
- Color: Black
- Unit: mm

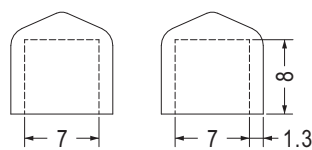

Part No.	Package
VC0707008	1000

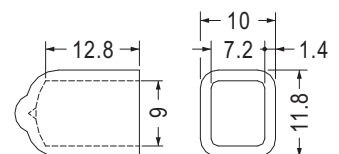

Part No.	Package
VC907413	1000

# 末端套管 VCP CAP

用途：特殊管末端切開時之保護套及各種電線，電纜運送途中防濕防塵用。



- Material: Soft P.V.C
- Color: Natural/Red/Black/Yellow/  
Green/Blue/White
- Unit: mm

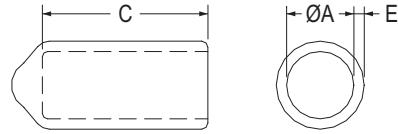

Part No.	A	C	E	Package
VCP02012	2.0	12.0	0.8	2000
VCP02607	2.6	7.0	0.8	
VCP02608	2.6	8.0	0.8	
VCP02609	2.6	9.0	0.8	
VCP03206	3.2	6.0	0.8	
VCP03210	3.2	10.0	0.8	
VCP03213	3.2	13.0	0.8	
VCP04006	4.0	6.0	0.8	1000
VCP04008	4.0	8.0	0.8	
VCP04809	4.8	9.0	1.0	
VCP04813	4.8	13.0	0.8	
VCP05708	5.7	8.0	1.0	
VCP05710	5.7	10.0	1.0	
VCP05713	5.7	13.0	1.0	
VCP06008	6.0	8.0	1.0	
VCP06012	6.0	12.0	1.0	

Part No.	A	C	E	Package
VCP06513	6.5	13.0	1.0	1000
VCP07013	7.0	13.0	1.0	
VCP07020	7.0	20.0	1.0	
VCP07608	7.6	8.0	1.0	
VCP07613	7.6	13.0	1.0	
VCP08008	8.0	8.0	1.0	
VCP08010	8.0	10.0	1.0	
VCP08509	8.5	9.0	1.0	
VCP08515	8.5	15.0	1.0	
VCP09516	9.5	16.0	1.0	
VCP10020	10.0	20.0	1.0	
VCP11420	11.4	20.0	1.2	
VCP12016	12.0	16.0	1.2	
VCP14035	14.0	35.0	1.2	
VCP15014	15.0	14.0	1.2	
VCP17813	17.8	13.0	1.2	
VCP22016	22.0	16.0	1.2	200



- Material: TPE (UL)
- Flame Class: 94HB
- Color: Black
- Unit: mm

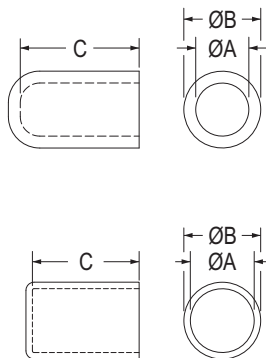

【 KSK079132 】

Part No.	A	B	C	Package
KSK024066	2.4	5.6	6.6	1000
KSK024122	2.4	6.3	12.2	
KSK029122	2.9	6.3	12.2	
KSK032097	3.2	5.5	9.7	
KSK032142	3.2	7.0	14.2	
KSK040130	4.0	5.5	13.0	
KSK040970	4.0	5.5	9.7	2000
KSK070105	7.0	11.0	10.5	1000
KSK070130	7.0	9.8	13.0	
KSK070180	7.0	9.8	18.0	
KS079132	7.9	9.5	13.2	
KSK080242	8.0	10.5	24.2	

# 軟質端子保護套 TERMINAL SOFT SLEEVES

用途：用於端子壓著後端子與外界間之絕緣，可作為線材之分色標記，安全美觀。

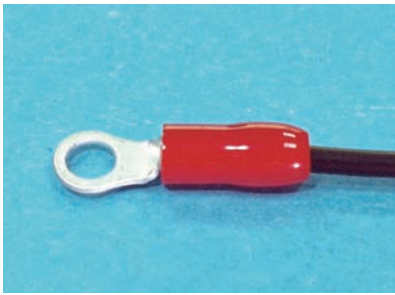

- Material: Soft P.V.C
- Color: Red/White/Black/Blue/  
Yellow/Green
- Unit: mm

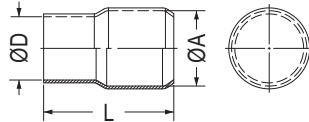

Part No.	Wire mm <sup>2</sup>	A	D	L	Package
V-1.25	1.25	3.3	3.1	15.0	100
V-2	2.0	4.5	3.7	16.0	
V-3.5	3.5	5.7	4.1	18.0	
V-5.5	5.5	5.7	5.2	20.0	
V-8	8.0	7.2	6.2	21.0	
V-14	14.0	10.0	8.0	28.0	
V-22	22.0	12.0	9.5	29.0	

Part No.	Wire mm <sup>2</sup>	A	D	L	Package
V-38	38.0	14.0	11.8	34.0	100
V-60	60.0	17.0	13.9	42.0	
V-70	70.0	17.9	15.1	45.0	
V-80	80.0	19.5	16.0	46.0	
V-100	100.0	22.0	18.0	55.0	50
V-125	125.0	24.4	20.0	60.0	
V-150	150.0	26.0	22.0	65.0	
V-185	185.0	29.0	24.0	66.7	
V-200	200.0	32.2	24.0	69.0	
V-250	250.0	37.5	26.5	75.0	25
V-325	325.0	37.5	30.0	75.0	
V-400	400.0	45.1	37.5	83.0	
V-500	500.0	48.2	40.2	85.0	
V-630	630.0	53.8	45.2	93.0	



- Material: Soft P.V.C
- Color: Natural/Blue
- Unit: mm

用途：用於端子壓著後端子與外界間之絕緣。

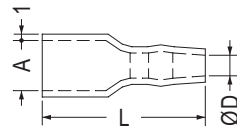

FLAT INSULATING SLEEVES

- 如需UL認可材質，請在料號尾碼加UL下單
- Please add UL after Part Number for UL certified material.

- 如需UL認可材質，請在料號尾碼加UL下單
- Please add UL after Part Number for UL certified material.

SERIES-110					
Part No.	A	D	L	Wire Size(O.D)	Package
S4020	4.0	2.0	22.0	2.0	2000
S4025	4.0	2.5	22.0	2.5	
S4028	4.0	2.8	22.0	2.8	
S4030	4.0	3.0	22.0	3.0	
S4035	4.0	3.5	22.0	3.0	

SERIES-187					
Part No.	A	D	L	Wire Size(O.D)	Package
S5825	5.8	2.5	22.0	2.5	1000
S5830	5.8	3.0	22.0	3.0	
S5835	5.8	3.5	22.0	3.5	
S5840	5.8	4.0	22.0	3.5	

SERIES-205					
Part No.	A	D	L	Wire Size(O.D)	Package
S6525	6.5	2.5	24.0	2.5	1000
S6530	6.5	3.0	24.0	3.0	
S6530/37	6.5	3.0	37.0	3.0	
S6535	6.5	3.5	24.0	3.5	
S6540	6.5	4.0	24.0	4.0	

SERIES-250					
Part No.	A	D	L	Wire Size(O.D)	Package
S8030	7.8	3.0	26.0	3.0	1000
S8035	7.8	3.5	27.0	3.5	
S8040	8.0	4.0	27.0	4.0	
S8045	8.0	4.5	27.0	4.5	
S8050	7.8	5.0	27.0	5.0	
S9535	9.5	3.5	26.0	3.5	

## 軟質端子保護套 TERMINAL SOFT SLEEVES

用途：用於端子壓著後端子與外界間之絕緣。



- Material: Soft P.V.C
- Color: Natural/Blue
- Unit: mm

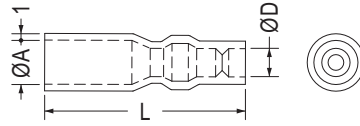

Part No.	A	D	L	Package
R4028/38	5.0	2.8	32.0	1000
R5025	5.0	2.5	33.0	
R5028	5.0	2.8	33.0	
R5030	5.0	3.1	33.0	
R5035	5.2	3.5	33.0	
R5040	5.5	4.0	33.0	



- Material: Soft P.V.C
- Color: Natural
- Unit: mm

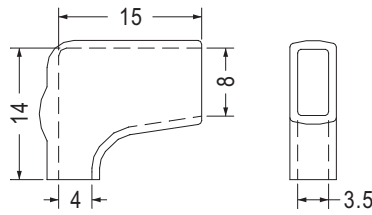

WIRE SIZE(O.D) Ø4.0

Part No.	Package
F8040	1000

## PC端子保護套 TERMINAL HOUSING

用途：用於電池端子之絕緣與保護。

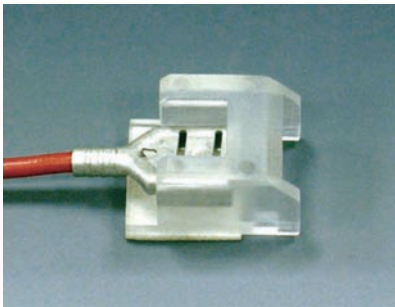

- Material: PC (UL)
- Flame Class: 94V-2
- Color: Natural
- Unit: mm

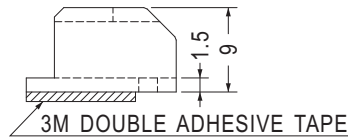
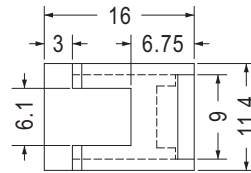

Part No.	Package
PCTT-1	1000

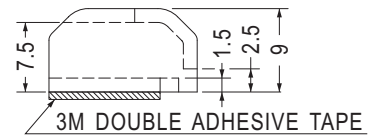
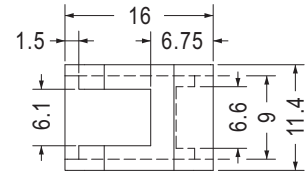

Part No.	Package
PCTT-2	1000

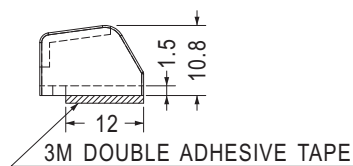
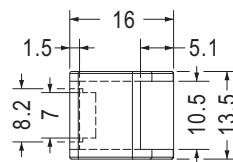

Part No.	Package
PCTT-3	1000

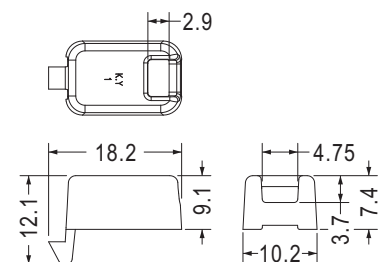

Part No.	Package
CVER-1	1000

# 保護蓋 INSULATED CAP

用途：用於HUB掛載孔之防塵與絕緣。



- Material: Nylon 66 (UL)/PC (UL)
- Flame Class: 94V-2/94V-0
- Color: Black
- Unit: mm

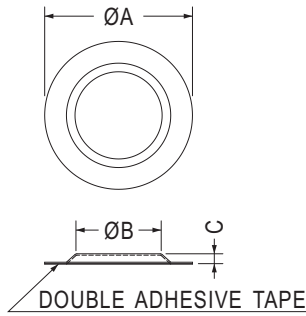

Part No.	A	B	C	Package
SCD-1	24.0	15.0	2.0	1000
SCD-2	31.5	18.0	2.4	
SCD-3	32.0	22.1	2.4	500
SCD-4	37.0	22.0	2.5	1000
SCD-8	26.0	18.6	2.3	
SCD-13	55.0	40.0	3.5	500
SCD-14	32.0	22.4	3.7	
★SCD-17	31.6	17.9	2.8	1000



- Material: Nylon 66 (UL)
- Flame Class: 94V-2/94V-0
- Color: Black
- Unit: mm

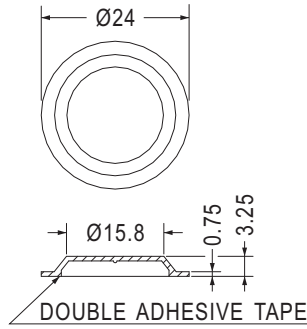

Part No.	Package
SCD-6	1000

6

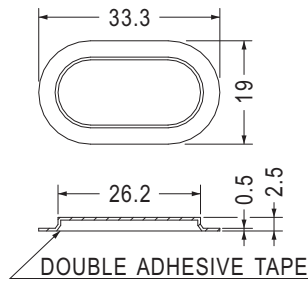

Part No.	Package
SCD-5	500

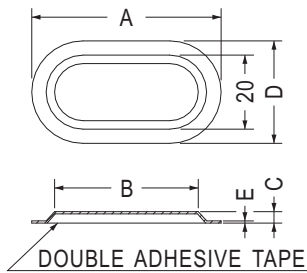

Part No.	A	B	C	D	E	Package
SCD-7	51.7	39.23	3.0	28.0	0.6	1000
SCD-15	42.0	24.6	4.5	24.0	0.5	

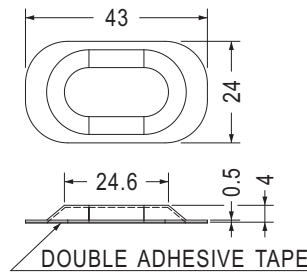

Part No.	Package
SCD-10	1000

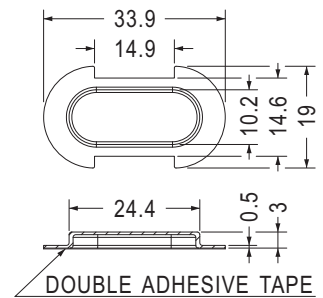

Part No.	Package
SCD-12	250

# 保護蓋 INSULATED CAP

用途：用於HUB掛載孔之防塵與絕緣。



- Material: Nylon 66 (UL)
- Flame Class: 94V-2/94V-0
- Color: Black
- Unit: mm

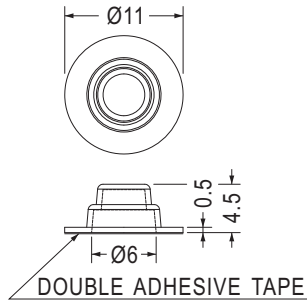

Part No.	Package
SCD-16	1000



- Material: PC (UL)
- Flame Class: 94V-2/94V-0
- Color: Black
- Unit: mm

用途：用於維修用孔之防塵與絕緣，可用螺絲固定。

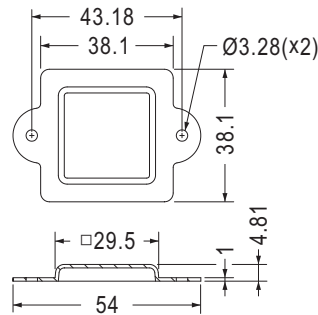

Part No.	Package
SCD-9	250



- Material: Nylon 66 (UL)
- Flame Class: 94V-2/94V-0
- Color: Natural/Black
- Unit: mm

用途：用於零件之防塵與保護。

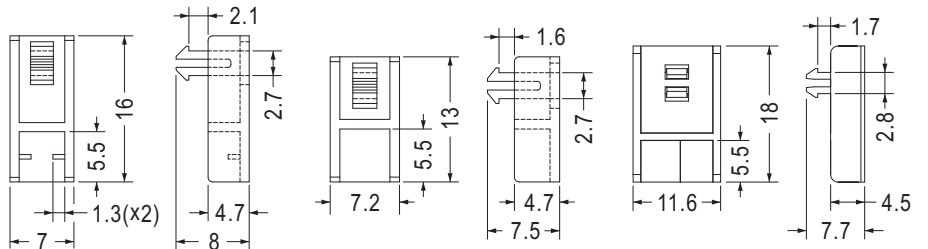

Part No.	Package
PH-25	1000

Part No.	Package
PH-41	1000

Part No.	Package
COVER-5	1000

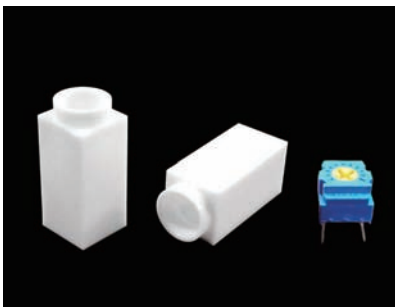

- Material: Nylon 66 (UL)
- Flame Class: 94V-2/94V-0
- Color: Natural/Black
- Unit: mm

用途：用於機器之可調電阻，灌膠之保護，可配合MHD系列使用。

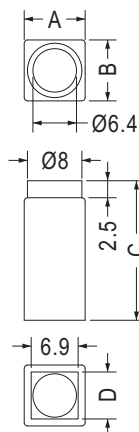

Part No.	A	B	C	D	Package
VRCVA-18	8.95	8.95	20.5	6.9	100
VRCVA-21.4	8.95	8.95	23.9	6.9	
VRCVA-27.5	8.95	8.95	30.0	6.9	
VRCVA-33	8.9	8.6	35.5	6.6	

## LED按鍵蓋 LED PUSHBUTTON CAP

用途：用於LED按鍵蓋。



- Material: PC (UL)
- Flame Class: 94V-2
- Color: Transparent
- Unit: mm

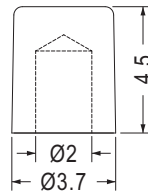

Part No.	Package
LEM-72	1000

## 測試針遮蓋 TEST PIN CAP

用途：把多餘PIN腳遮蓋，避免刺傷工作人員。



- Material: Nylon 66 (UL)
- Flame Class: 94V-2/94V-0
- Color: Natural/Black
- Unit: mm

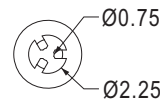
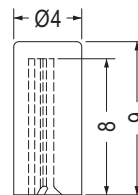

Part No.	Package
TSC-42	1000

## 端子蓋 CONNECTOR COVER

用途：用於端子之絕緣。



- Material: Nylon 66 (UL)
- Flame Class: 94V-2/94V-0
- Color: Natural/Black
- Unit: mm

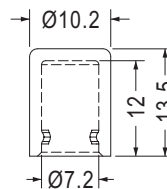

Part No.	Package
TSC-28	1000

## 開關蓋 TACT SWITCH CAP

用途：用於TACT開關之帽蓋。



- Material: Nylon 66 (UL)
- Flame Class: 94V-2/94V-0
- Color: Natural/Black
- Unit: mm

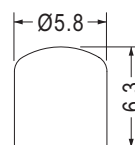

Part No.	Package
PENCOMC-1	2000

# 開關蓋 TACT SWITCH CAP

用途：用於開關之帽蓋。

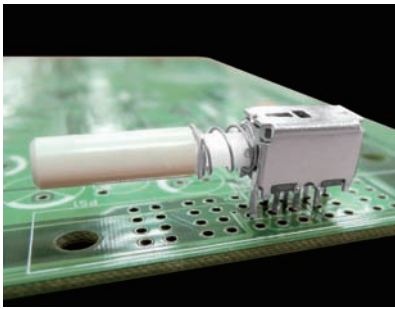

- Material: PC+ABS (UL)
- Flame Class: 94V-0
- Color: Black/White
- Unit: mm

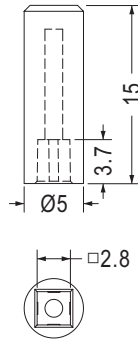

Part No.	Package
TSC-22	1000

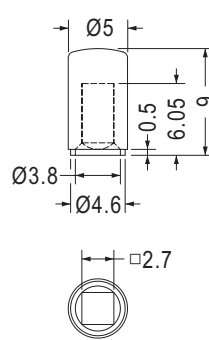

Part No.	Package
TSC-23	1000

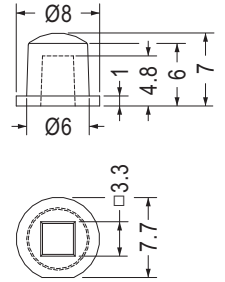

- Material: ABS (UL)
- Flame Class: 94HB

Part No.	Package
TSC-11	1000



- Material: Nylon 66 (UL)
- Flame Class: 94V-2/94V-0
- Color: Natural/Black
- Unit: mm

用途：用於TACT開關之帽蓋。

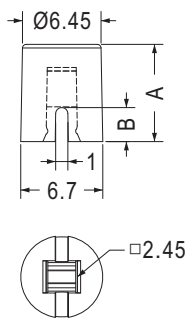

Part No.	A	B	Package
TSC-8	6.0	2.5	1000
TSC-46	8.0	2.8	

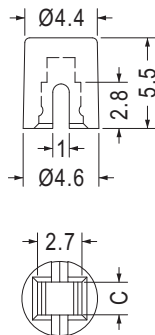

Part No.	C	Package
TSC-19	2.0	1000
TSC-33	2.5	

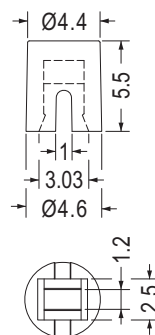

Part No.	Package
TSC-32	1000

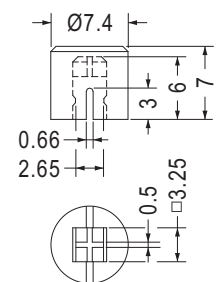

Part No.	Package
TSC-10	1000



- Material: Nylon 66 (UL)/ABS (UL)
- Flame Class: 94HB/94V-2/94V-0
- Color: Natural/Black
- Unit: mm

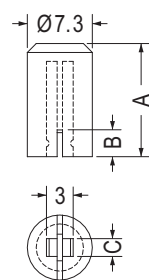

Part No.	A	B	C	Package
TSC-4	12.7	3.0	2.0	1000
TSC-5	12.7	4.2	3.0	
TSC-25	11.6	3.0	2.0	

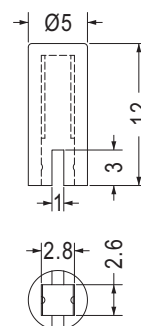

Part No.	Package
TSC-26	1000

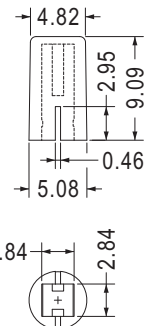

Part No.	Package
TSC-49	2000

# 開關蓋 TACT SWITCH CAP

用途：用於TACT開關之帽蓋。



- Material: Nylon 66 (UL)
- Flame Class: 94V-2/94V-0
- Color: Natural/Black
- Unit: mm

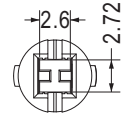
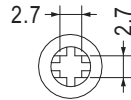
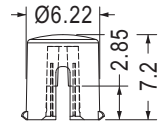
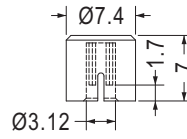
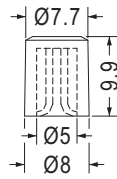

- Material: ABS (UL)
- Flame Class: 94HB

- Material: ABS

Part No.	Package
TSC-6	1000

Part No.	Package
TSC-40	1000

Part No.	Package
TSC-45	1000



- Material: Nylon 66 (UL)
- Flame Class: 94V-2/94V-0
- Color: Natural/Black
- Unit: mm

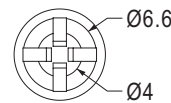
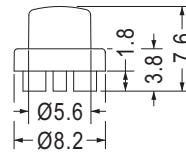

Part No.	Package
TSC-20	1000



- Material: PC+ABS (UL)
- Flame Class: 94V-0
- Color: Black/Gray
- Unit: mm

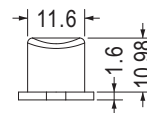
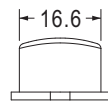
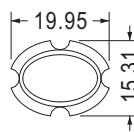

Part No.	Package
TSC-9	500

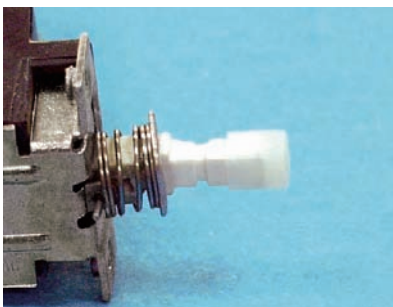

- Material: Nylon 66 (UL)
- Flame Class: 94V-2/94V-0
- Color: Natural/Black
- Unit: mm

用途：用於開關之加長與保護。

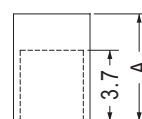

Part No.	A	Package
SWC-1	5.6	2000
SWC-2	4.7	

# 開關蓋 TACT SWITCH CAP

用途：用於TACT開關之帽蓋。

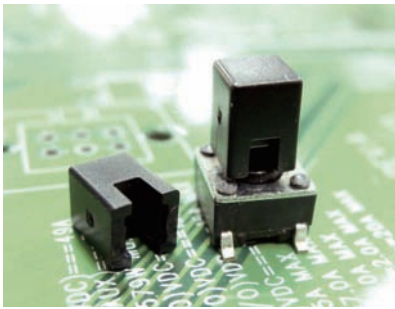

- Material: ABS (UL)
- Flame Class: 94HB
- Color: Black
- Unit: mm

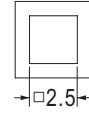
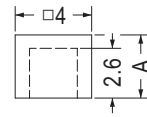
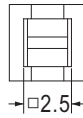
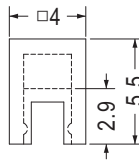

Part No.	Package
TSC-1	1000

Part No.	A	Package
TSC-2	3.3	2000
TSC-2A	4.0	

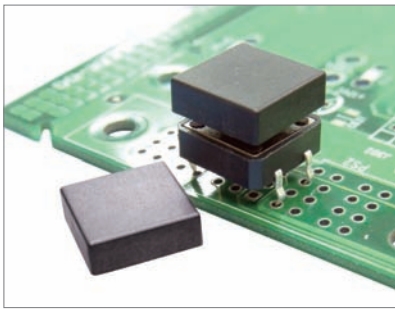

- Material: ABS (UL)
- Flame Class: 94HB
- Color: Black
- Unit: mm

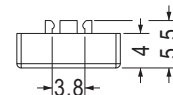
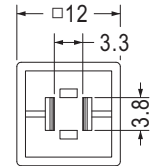
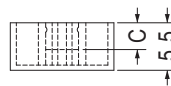
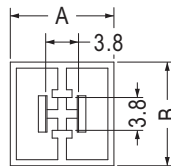

Part No.	A	B	C	Package
TSC-3	12.0	12.0	3.1	1000
TSC-18	9.0	9.0	2.8	

Part No.	Package
TSC-36	1000

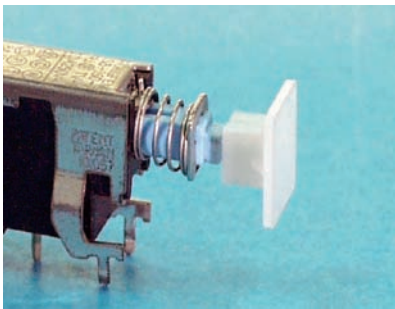

- Material: Nylon 66 (UL)/PC+ABS (UL)
- Flame Class: 94V-2/94V-0
- Color: Natural/Black/Gray
- Unit: mm

用途：用於開關之帽蓋。

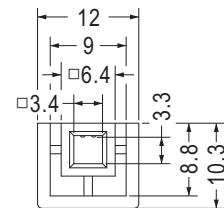
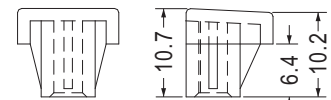
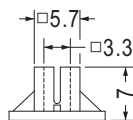
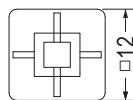

Part No.	Package
SWCL-7	1000

Part No.	Package
SWCL-10	1000

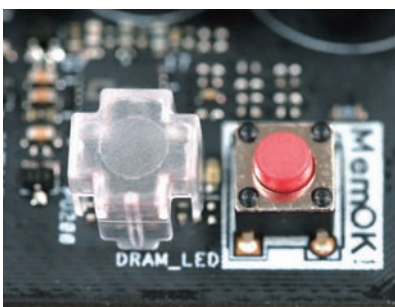

- Material: PC (UL)
- Flame Class: 94V-2
- Color: Transparent
- Unit: mm

用途：防止TACT開關之誤觸。

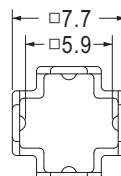
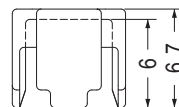

Part No.	Package
TSC-38	1000

# 開關蓋 SWITCH COVER

用途：用於電源插座防塵與保護。



- Material: PVC
- Color: Transparent
- Unit: mm

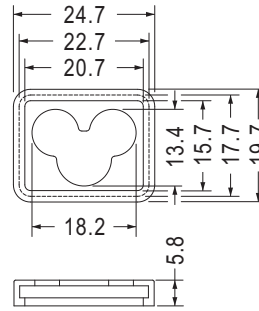

Part No.	Package
ABSC-2318	1000

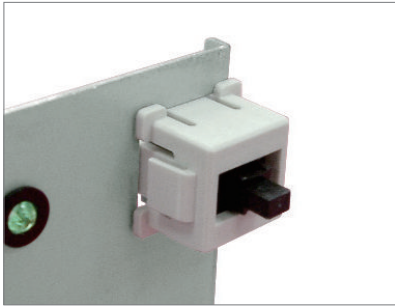

- Material: PC+ABS (UL)
- Flame Class: 94V-0
- Color: Natural/Black
- Unit: mm

用途：將TACT開關固定於機板上。

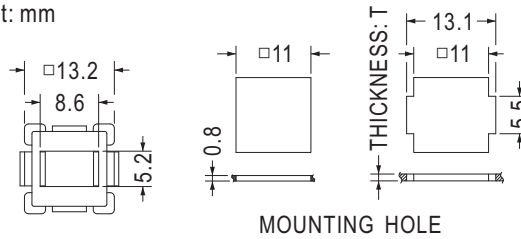

MOUNTING HOLE

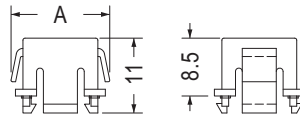

Part No.	A	T	Package
TSC-7	14.5	1.0	500
TSC-7L	14.3	1.4	

- Material: ABS (UL)
- Flame Class: 94HB
- Color: Natural/Computer
- Unit: mm

- Material: ABS (UL)
- Flame Class: 94HB/94V-0
- Color: Natural/Black/Computer
- Unit: mm

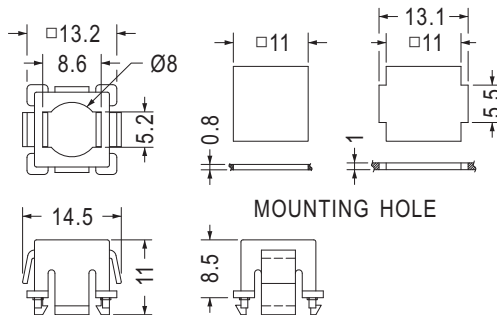

MOUNTING HOLE

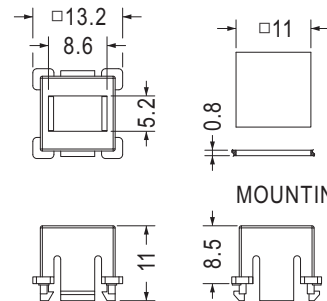

MOUNTING HOLE

Part No.	Package
TSC-7T	1000

Part No.	Package
TSC-7Y	1000

- Material: PC+ABS (UL)
- Flame Class: 94V-2/94V-0
- Color: Natural/Black
- Unit: mm

- Material: ABS (UL)
- Flame Class: 94HB
- Color: Black
- Unit: mm

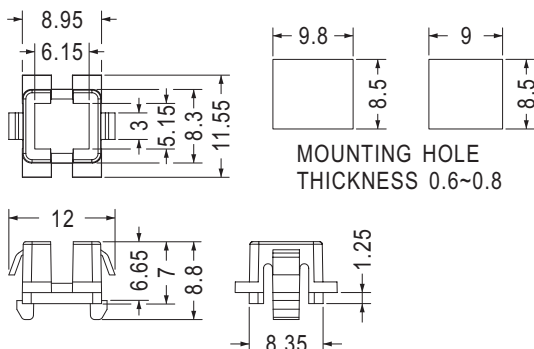

MOUNTING HOLE  
THICKNESS 0.6~0.8

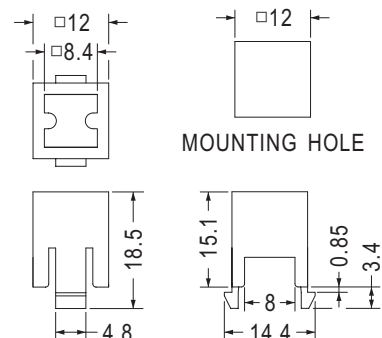

MOUNTING HOLE

Part No.	Package
TSC-27	1000

Part No.	Package
TSC-24	1000

## 麥克風或電容套 MIC OR CAPACITOR CAP

用途：用於麥克風或電容之帽套，防止共振。

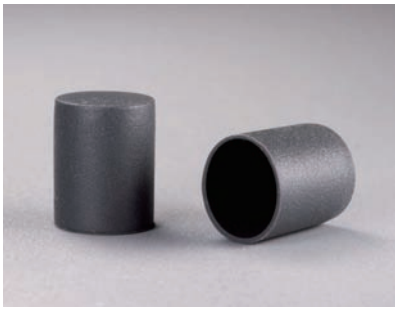

- Material: Rubber/Silicon Rubber (UL)
- Flame Class: 94V-0
- Color: Black
- Unit: mm

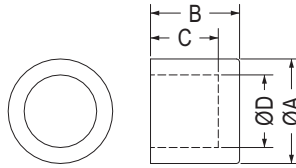

Part No.	A	B	C	D	Package
MIC-3	10.8	9.2	7.0	7.5	1000
MIC-40	9.6	12.0	11.5	8.6	
MIC-44	9.6	10.0	9.5	8.6	

## 麥克風套 MIC HOLDER

用途：用於麥克風之帽套，防止共振。



- Material: Rubber/Silicon Rubber/  
Silicon Rubber (UL)
- Flame Class: 94V-0
- Color: Black
- Unit: mm

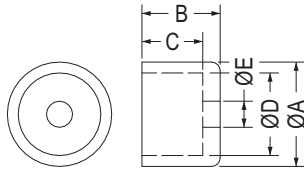

Part No.	A	B	C	D	E	Package
MIC-1	12.0	8.6	7.0	9.5	3.0	1000
MIC-1A	12.5	9.0	7.0	9.5	3.0	
MIC-4	8.0	6.0	5.0	5.8	3.0	2000
MIC-9	7.1	3.3	2.5	6.0	4.0	
MIC-30	8.4	5.5	5.0	7.6	4.5	
MIC-32	7.1	4.7	4.0	6.0	4.0	1000
MIC-36	10.5	6.8	6.0	10.0	4.0	
MIC-38	25.1	12.0	10.9	22.8	16.1	
MIC-45	7.8	10.0	8.5	4.8	1.0	

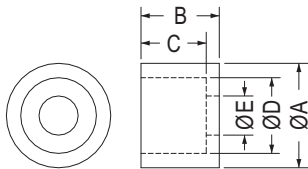

Part No.	A	B	C	D	E	Package
MIC-5	8.0	4.0	3.0	6.0	2.8	2000
MIC-42	8.6	6.8	6.5	8.0	5.6	
MIC-43	25.0	12.3	6.7	12.5	6.0	

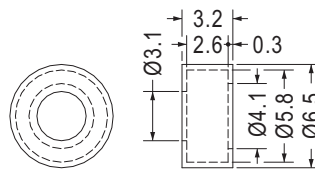

Part No.	Package
MIC-6	2000

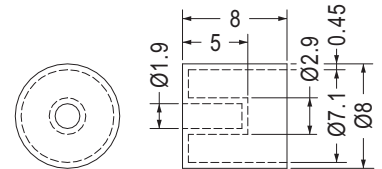

Part No.	Package
MIC-10	1000

## 矽膠蓋 SILICON RUBBER CAP

用途：用於零件之保護，防塵美觀。



- Material: Silicon Rubber (UL)
- Flame Class: 94V-0
- Color: Black
- Unit: mm

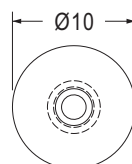
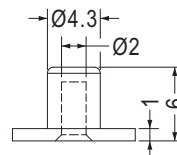

Part No.	Package
TF-1198	1000

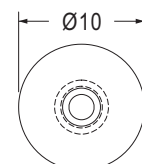
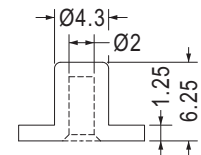

Part No.	Package
TF-1679	1000

## 矽膠蓋 SILICON RUBBER CAP

用途：用於零件之保護，防塵美觀。



- Material: Silicon Rubber
- Color: Black
- Unit: mm

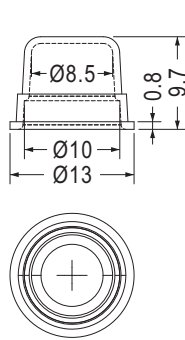

Part No.	Package
TF-1639	1000

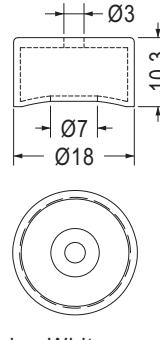

- Color: White

Part No.	Package
TF-1575	1000

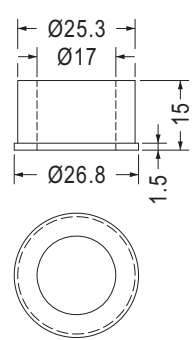

Part No.	Package
MIC-39	1000

## 麥克風座 MIC HOLDER

用途：用於麥克風座，可降低雜音、噪音。

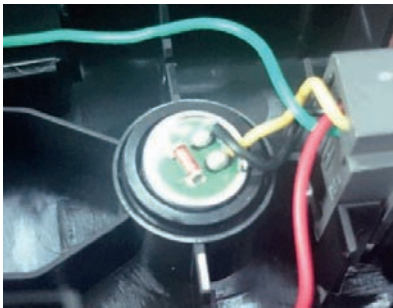

- Material: PE
- Color: Black
- Unit: mm

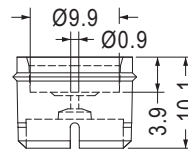

Part No.	Package
MIC-31	1000

## 開關蓋 TACT SWITCH CAP

用途：開關之絕緣。



- Material: PE
- Color: Black
- Unit: mm

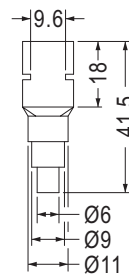

Part No.	Package
EM-19	250

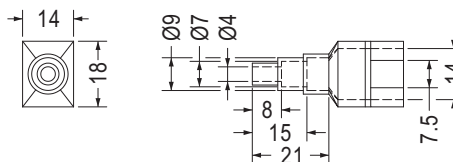

## 絕緣蓋 INSULATOR COVER

用途：用於波段開關旋鈕。



- Material: Nylon 66 (UL)
- Flame Class: 94V-2/94V-0
- Color: Natural/Black
- Unit: mm

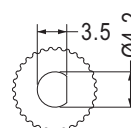
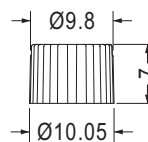

Part No.	Package
EMAC-463	1000